

# OpenScape Business V2 OpenScape Business X3/X5/X8

**Service documentation**

A31003-P3020-S100-12-7620

Provide feedback to further optimize this document to [edoku@unify.com](mailto:edoku@unify.com).

As reseller please address further presales related questions to the responsible presales organization at Unify or at your distributor. For specific technical inquiries you may use the support knowledgebase, raise - if a software support contract is in place - a ticket via our partner portal or contact your distributor.

Our Quality and Environmental Management Systems are implemented according to the requirements of the ISO9001 and ISO14001 standards and are certified by an external certification company.

Copyright © Unify Software and Solutions GmbH & Co. KG 03/2018

All rights reserved.

Reference No.: A31003-P3020-S100-12-7620

The information provided in this document contains merely general descriptions or characteristics of performance which in case of actual use do not always apply as described or which may change as a result of further development of the products. An obligation to provide the respective characteristics shall only exist if expressly agreed in the terms of contract.

Availability and technical specifications are subject to change without notice.

Unify, OpenScape, OpenStage and HiPath are registered trademarks of Unify Software and Solutions GmbH & Co. KG. All other company, brand, product and service names are trademarks or registered trademarks of their respective holders.

# Contents

<b>1 Introduction and Important Notes</b>	<b>7</b>
1.1 About this Documentation	7
1.1.1 Documentation and Target Groups	7
1.1.2 Structure of the Service Documentation	9
1.1.3 Types of Topics	10
1.1.4 Display Conventions	10
1.2 Safety Information and Warnings	11
1.2.1 Warnings: Danger	12
1.2.2 Warnings: Warning	12
1.2.3 Warnings: Caution	13
1.2.4 Warnings: Note	14
1.2.5 Country-specific Safety Information	15
1.2.5.1 Safety Information for Australia	15
1.2.5.2 Safety Information for Brazil	16
1.2.5.3 Safety Information for the U.S.	16
1.2.5.4 Safety Information for Canada	18
1.3 Important Notes	19
1.3.1 Emergencies	19
1.3.2 Proper Use	20
1.3.3 Correct Disposal and Recycling	20
1.3.4 Installation Standards and Guidelines	21
1.3.4.1 Connecting OpenScape Office X to the Power Supply Circuit	21
1.3.4.2 Connecting OpenScape Business S and OpenScape Business UC Booster Server to the Power Supply Circuit	22
1.3.4.3 Shielded Cabling for LAN and WAN Connections of OpenScape Business X	22
1.3.4.4 Fire Safety Requirements	23
1.3.4.5 Lightning Protection Requirements	23
1.3.4.6 Markings for OpenScape Business X	24
1.3.5 Notes on Electromagnetic and Radio Frequency Interference of OpenScape Business X	24
1.3.6 Data Protection and Data Security	24
1.3.7 Technical Regulations and Conformity of OpenScape Business X	25
1.3.7.1 CE Conformity	25
1.3.7.2 Conformity with US and Canadian Standards	26
1.3.7.3 Conformity with International Standards	26
1.3.8 Operating Conditions	26
1.3.8.1 Operating Conditions for OpenScape Business X	26
1.3.8.2 Operating Conditions for OpenScape Business S and OpenScape Business UC Booster Server	27
<b>2 Communication Systems</b>	<b>28</b>
2.1 OpenScape Business X3R	28
2.2 OpenScape Business X3W	29
2.3 OpenScape Business X5R	30
2.4 OpenScape Business X5W	31
2.5 OpenScape Business X8	32
<b>3 Boards</b>	<b>35</b>
3.1 Overview of Modules	35
3.1.1 Central Boards	36

## Contents

3.1.2	Peripheral boards	38
3.1.3	Options	41
3.1.4	Boards and Devices Being Phased Out	42
3.2	Description of the Boards	46
3.2.1	CMA/CMAe	46
3.2.1.1	How to Install CMA or CMAe on OCCM	49
3.2.1.2	How to Install CMA or CMAe on OCCMR	52
3.2.2	CUX5W	53
3.2.3	CUX5R	54
3.2.4	CUX3W	55
3.2.5	CUX3R	55
3.2.6	DBSAP	56
3.2.7	DIUT2	57
3.2.8	EXMR	61
3.2.8.1	How to Install EXMR on OCCL	63
3.2.8.2	How to Install EXMR on OCCM	64
3.2.8.3	How to Install EXMR on OCCMR	66
3.2.9	IVMNL	66
3.2.10	IVMP4, IVMP4R	70
3.2.11	IVMS8N, IVMS8NR	74
3.2.12	LUNA2	77
3.2.13	MMP3R	83
3.2.14	MUSIC plugin module	83
3.2.15	MPPI USB EXM	84
3.2.16	OCAB (UC Booster Card)	86
3.2.16.1	How to Mount the OCAB and the Fan Kit in an X8 System	91
3.2.16.2	How to Mount the OCAB and the Fan Kit in an X3W or X5W System	98
3.2.16.3	How to Mount the OCAB and the Fan Kit in an X3R or X5R System	110
3.2.17	OCCB1, OCCB3	117
3.2.17.1	How to Install OCCB1/OCCB3 on OCCL	119
3.2.17.2	How to Install OCCB1/OCCB3 on OCCM	121
3.2.17.3	How to Install OCCB1/OCCB3 on OCCMR	125
3.2.18	OCCL	128
3.2.19	OCCM	134
3.2.20	OCCMR	143
3.2.21	OCPSA	152
3.2.22	OCPSM	152
3.2.22.1	How to Replace X3W/X5W PSU by OCPSM	156
3.2.22.2	How to Replace X3R/X5R PSU by OCPSM	161
3.2.23	REALS	165
3.2.24	SLAV4, SLAV8, SLAV8R	170
3.2.25	SLAV16, SLAV16R	173
3.2.25.1	How to Install a Fan Kit in an OpenScape Business X5W	179
3.2.25.2	How to Install a Fan Kit in an OpenScape Business X5R	183
3.2.26	Not for U.S.: SLC16N	185
3.2.27	Not for U.S.: SLCN	189
3.2.28	SLMAV8N, SLMAV24N	194
3.2.29	SLMO8N, SLMO24N	205
3.2.30	SLMU	215
3.2.31	SLMUC	222
3.2.32	SLU8N, SLU8NR	230
3.2.33	STLSX2, STLSX4, STLSX4R	232



3.2.34	STMD3	236
3.2.35	STRB, STRBR	242
3.2.36	For Selected Countries Only: TCAS-2, TCASR-2	249
3.2.36.1	How to Connect the Cable Shield of the Coaxial Cables (CAS Cables) to the Housing of the OpenScape Business X5W Communication System	256
3.2.37	ET-S	259
3.2.38	TLANI2, TLANI4, TLANI4R	260
3.2.39	TLANI8	264
3.2.40	TMANI	266
3.2.41	For Selected Countries Only: TMCAS2	273
3.2.42	For Selected Countries Only: TMDID	279
3.2.43	For Selected Countries Only: TMEW2	286
3.2.43.1	How to Install a SIVAPAC-SIPAC Board Adapter	291
3.2.43.2	How to Replace a Board Latch	292
3.2.44	Not for U.S.: TS2N, TS2RN	293
3.2.45	For Selected Countries Only: TST1, TST1R	297
3.2.46	UPSC-D	299
3.2.47	UPSC-DR	303
<b>4</b>	<b>Extensions</b>	<b>309</b>
4.1	Installing the Hardware of the OpenScape Business Powerbox	309
4.1.1	Construction Data	311
4.1.2	Controls, Indicators and Connections	311
4.1.3	Components	314
4.1.4	OpenScape Business Powerbox with Batteries and/or LUNA2 Power Supply	315
<b>5</b>	<b>Integrated Cordless Solution</b>	<b>318</b>
5.1	System Overview	319
5.1.1	System Configuration	320
5.1.2	Power-Related Capacity Limits	322
5.1.3	Traffic capacity	322
5.1.4	Grade Of Service (GOS)	323
5.1.5	Multi-SLC	323
5.1.6	Single-Cell Mode	325
5.1.7	Network-wide Roaming	325
5.1.8	Clock Supply	326
5.2	Base Station BS5	326
5.2.1	Technical Data	327
5.2.2	Pin Assignments	328
5.2.3	LEDs	329
5.2.4	Operating Range	331
5.2.5	Outdoor Housing	333
5.3	Project Planning Guidelines for a Cordless Solution	335
5.3.1	Considering the Volume of Traffic	335
5.3.2	Considering the Propagation Conditions for Radio Traffic	335
5.3.3	Placement of Base Stations Indoors	339
5.3.4	Placement of Base Stations Outdoors	344
5.4	Installing and Connecting Base Stations	346
5.4.1	Prerequisites for Installation	346
5.4.2	Installation Indoors	348
5.4.2.1	How to Mount the Base Station Indoors	348
5.4.3	Outdoor Installation	349
5.4.4	Connection of Base Stations	349

## Contents

5.4.4.1 How to Connect the Base Station .....	349
5.5 Testing a Cordless Solution .....	351
5.5.1 Checking the Base Stations and the Radio Coverage .....	351
5.5.1.1 Testing Base Stations .....	352
5.5.1.2 Check the Radio Coverage .....	354
5.5.2 Documentation of the Test Results .....	355
5.6 Troubleshooting .....	356
<b>6 Appendix .....</b>	<b>358</b>
6.1 Hardware Expansion .....	358
6.2 Interface Ranges for Subscriber Lines .....	363
6.3 Cable Lengths for Trunk Connections and CorNet NQ/QSIG Direct Networking .....	363
6.4 Country-Specific Ring Frequencies for Analog Subscriber Line Modules .....	364
6.5 Power Requirements of a Communication System .....	365
6.5.1 Boards Power Requirement .....	366
6.5.2 Power Requirements of Telephones and Devices .....	375
6.5.3 Nominal Power Output of the Power Supply Units .....	378
6.5.3.1 How to Check if the Power Output of a Power Supply is Sufficient .....	379
6.5.4 Primary Power Requirements of a Communication System .....	382
6.5.4.1 How to Determine the Primary Power Requirements of a Communication System .....	382
<b>Index .....</b>	<b>385</b>

# 1 Introduction and Important Notes

This introduction provides you with an overview of the documentation structure. The introduction should assist you in finding information on selected topics faster. Before you begin with the installation and startup of the communication system, make sure that you have carefully read the safety information and warnings as well as the important notes.

---

**INFO:** The safety information and requirements inform you about the safety and other requirements to be observed. The important notes contain information on the emergency behavior, the standards and guidelines for the installation, and the radio frequency interference of the communication system. In addition, you will also find details on and the proper disposal and recycling of the communication system here.

---

## 1.1 About this Documentation

This documentation provides you with information on the boards and extensions for the OpenScape Business X<sup>TM</sup> hardware models.

The information contained in this documentation should only be considered a guideline and does not replace any training.

This document is intended for administrators and service technicians.

For more information beyond the contents of this document, please refer to the *OpenScape Business Administrator Documentation* and the *OpenScape Business Installation Guides*.

### 1.1.1 Documentation and Target Groups

The documentation for OpenScape Business is intended for various target groups.

#### **Sales and Project Planning**

The following documentation is intended for sales and project planning.

- Feature Description

This documentation describes all the features. This document is an extract from the Administrator Documentation.

#### **Installation and Service**

The following documentation is intended for service technicians.

## Introduction and Important Notes

### About this Documentation

- OpenScape Business X1, Installation Guide  
This document describes the installation of the hardware and the initial installation of OpenScape Business X1.
- OpenScape Business X3/X5/X8, Installation Guide  
This document describes the installation of the hardware and the initial installation of OpenScape Business X3/X5/X8.
- OpenScape Business S, Installation Guide  
This documentation describes the initial installation of the OpenScape Business S softswitch.
- OpenScape Business X1, Service Documentation  
This documentation describes the hardware of OpenScape Business X1.
- OpenScape Business X3/X5/X8, Service Documentation  
This documentation describes the hardware of OpenScape Business X3/X5/X8.

### Administration

The following documentation is intended for administrators.

- Administrator Documentation  
This documentation describes the configuration of features that are set up using the OpenScape Business Assistant (WBM). The Administrator documentation is available in the system as online help.
- Configuration for Customer Administrators, Administrator Documentation  
This documentation describes the configuration of features that can be set up using the OpenScape Business Assistant (WBM) with the **Basic** administrator profile.
- Manager E, Administrator Documentation  
This documentation describes the configuration of features that are set up using Manager E.

### UC Clients / Telephone User Interfaces (TUI)

The following documentation is intended for UC users.

- myPortal Smart, User Guide  
This documentation describes the configuration and operation of the UC client myPortal Smart.
- myPortal for OpenStage, User Guide  
This documentation describes the configuration and operation of myPortal for OpenStage.
- myPortal for Desktop, User Guide  
This documentation describes the installation, configuration and operation of the UC client myPortal for Desktop.
- myPortal for Outlook, User Guide  
This documentation describes the installation, configuration and operation of the UC client myPortal for Outlook.
- Fax Printer, User Guide  
This documentation describes the installation, configuration and operation of Fax Printer.

- **myPortal to go User Guide**  
This documentation describes the configuration and operation of the mobile UC client myPortal to go for smartphones and tablet PCs.
- **myAgent, User Guide**  
This documentation describes the installation, configuration and operation of the Contact Center client myAgent.
- **myReports, User Guide**  
This documentation describes the installation, configuration and operation of the Contact Center client myReports.
- **myAttendant, User Guide**  
This documentation describes the installation, configuration and operation of the attendant console myAttendant.
- **OpenScape Business Attendant, User Guide**  
This documentation describes the installation, configuration and operation of the attendant console OpenScape Business Attendant.
- **UC Smart Telephone User Interface (TUI), Quick Reference Guide**  
This documentation describes the voicemail phone menu of the UC solution UC Smart.
- **UC Suite Telephone User Interface (TUI), Quick Reference Guide**  
This documentation describes the voicemail phone menu of the UC solution UC Suite.

## 1.1.2 Structure of the Service Documentation

This section shows you how the content of the Service Documentation is structured. Information on the initial installation and the configuration can be found in the Administrator Documentation.

Chapter	Contents
Introduction and Important Notes	Overview of the structure this documentation, safety information and warnings and warnings, notes about behavior in the case of emergencies, and the intended use and operating conditions of the communication systems and servers
Communication systems	Description of communication systems OpenScape Business X3R, X3W, X5R, X5W and X8
Boards	Overview and description of the orderable boards



Chapter	Contents
Extensions	Information on connecting auxiliary equipment
Integrated Cordless Solution	System configuration and capacity limits, base stations and their installation, guidelines for project planning
Appendix	Hardware expansion, interface ranges, cable lengths, country-specific call frequencies

### 1.1.3 Types of Topics

The types of topics include concepts and tasks:

Type of topic	Description
Concept	Explains the "What" and provides an overview of context and background information for specific features, etc.
Task (operating instructions)	Describes task-oriented application cases (i.e., the "How") step-by-step and assumes familiarity with the associated concepts.  Tasks can be identified by the title <b>How to</b> ....

### 1.1.4 Display Conventions

This documentation uses a variety of methods to present different types of information.

Type of information	Presentation	Example
User Interface Elements	Bold	Click <b>OK</b> .
Menu sequence	>	<b>File &gt; Exit</b>
Special emphasis	Bold	<b>Do not delete</b> Name.
Cross-reference text	Italics	You will find more information in the topic <i>Network</i> .
Output	Monospace font, e.g., Courier	Command not found.
Input	Monospace font, e.g., Courier	Enter LOCAL as the file name.
Key combination	Monospace font, e.g., Courier	<Ctrl>+<Alt>+<Esc>

## 1.2 Safety Information and Warnings

Safety information and warnings indicate situations that can result in death, injury, property damage, and/or data loss.

Work on the communication systems and devices should **only** be performed by personnel with proper qualifications.

Within the context of this safety information and these warnings, qualified personnel are people who are authorized to ground and label systems, devices, and trunks and put them into operation in compliance with the applicable safety regulations and standards.

Make sure you have read and noted the following safety information and warnings before installing and starting up the communication system:

Make sure you also read carefully and follow all safety information and warnings printed on the communication system and devices.

Familiarize yourself with emergency numbers.

### Types of Safety Information and Warnings

This documentation uses the following levels for the different types of safety information and warning:



#### **DANGER**

Indicates an immediately dangerous situation that will cause death or serious injuries.

---



#### **WARNING**

Indicates a universally dangerous situation that can cause death or serious injuries.

---



#### **CAUTION**

Indicates a dangerous situation that can cause injuries.

---

---

**NOTICE:** Indicates situations that can cause property damage and/or data loss.

---

**Additional symbols for specifying the source of danger more exactly**

The following symbol is generally not used in this documentation, but may appear on the devices or packaging.



ESD - electrostatically sensitive devices

### 1.2.1 Warnings: Danger

"Danger" warnings indicate immediately dangerous situations that will cause death or serious injury.



---

**DANGER**

**Risk of electric shock through contact with live wires**

- Note: Voltages over 30 VAC (alternating current) or 60 VDC (direct current) are dangerous.
  - Only personnel with proper qualifications or qualified electricians should perform work on the low-voltage network (<1000 VAC), and all work must comply with the national/local requirements for electrical connections.
- 

### 1.2.2 Warnings: Warning

"Warnings" indicate universal dangerous situations that can cause death or serious injury.



---

**WARNING**

**Risk of electric shock through contact with live wires**

- Use separate ground wires to provide protective grounding for the OpenScope Business X3R, X3W, X5R and X5W communication systems. Before you start up the system and connect the phones and phone lines, connect the communication system with a permanent earthing conductor.
- Provide protective grounding for each system box of the OpenScope Business X8 communication system with a separate ground wire. Before you

start up the system and connect the phones and phone lines, connect the communication system with a permanent earthing conductor.

- Only use systems, tools and equipment which are in perfect condition. Do not use equipment with visible damage.
- Replace any damaged safety equipment (covers, labels and ground wires) immediately.
- Replace the power cable immediately if it appears to be damaged.
- The communication systems and servers should only be operated with outlets that have connected ground contacts.
- During a thunderstorm, do not connect or disconnect lines and do not install or remove boards.
- Disconnect all power supply circuits if you do not require power for certain activities (for example, when changing cables). Disconnect all the communication system's power plugs and make sure that the communication system is not supplied by another power source (uninterrupted power supply unit, for instance).

Before starting any work, make sure that the communication system is de-energized. Never take it for granted that all circuits have reliably been disconnected from the power supply when a fuse or a main switch has been switched off.

- Expect leakage current from the telecommunications network. Disconnect all telecommunication lines from the communication system before disconnecting the prescribed ground wire from the system.
- As long as the power supply is switched on, always observe the greatest caution when performing measurements on powered components and maintenance work on PC boards and covers.

Metallic surfaces such as mirrors are conductive. If you touch them, there is a risk of electric shocks or short circuits.

---

### 1.2.3 Warnings: Caution

"Caution" warnings indicate a dangerous situation that can result in injury.



#### **CAUTION**

##### **Risk of explosion caused by the incorrect replacement of batteries**

- Use only the approved battery packs.
  - The lithium battery should only be replaced with an identical battery or one recommended by the manufacturer.
-



**CAUTION**

**Fire hazard**

- Only use communication lines with a conductor diameter of 0.4 mm (AWG 26) or more.
  - Do not store any documents or similar flammable items in a communication system.
- 



**CAUTION**

**Risk of injury resulting from laser radiation.**

Do not look directly into the beam of an optical interface.

---



**CAUTION**

**General risk of injury or accidents in the workplace**

- After completing test and maintenance work, make sure that all safety equipment is re-installed in the right place and that all covers and the housing are closed.
  - Install cables in such a way that they do not pose a risk of an accident (tripping), and cannot be damaged.
  - When working on an open communication system or server, make sure that it is never left unattended.
  - Use appropriate tools to lift heavy objects or loads.
  - Check your tools regularly. Only use intact tools.
  - When working on the systems, never wear loose clothing and always tie back long hair.
  - Do not wear jewelry, metal watchbands or clothes with metal ornaments or rivets.
  - Always wear the necessary eye protection whenever appropriate.
  - Always wear a hard hat where there is a risk of injury from falling objects.
  - Make sure that the work area is well lit and tidy.
- 

## 1.2.4 Warnings: Note

"Note" warnings are used to indicate situations that could result in property damage and/or data loss.



The following contains important information on how to avoid property damage and/or data loss:

- Before placing the system into operation, check whether the nominal voltage of the mains power supply corresponds to the nominal voltage of the communication system or server (type plate).
- Follow these ESD measures to protect the electrostatically sensitive devices:
  - Always wear the antistatic wristband in the prescribed manner before performing any work on PC boards and modules.
  - Always place PC boards and modules on a grounded conductive base.
  - Make sure that the components of the communication system (e.g., the boards) are transported and shipped only in the appropriate packaging.
- Use only original accessories. Failure to comply with this safety information may damage the system equipment or violate safety and EMC regulations.
- Sudden changes in temperature can result in condensing humidity. If a communication system or server is transported from a cold environment to warmer areas, for example, this could result in the condensation of humidity. Wait until the communication system or server has adjusted to the ambient temperature and is completely dry before starting it up.
- Connect all cables only to the specified connection points.
- If no emergency backup power supply is available or if no switchover to emergency analog phones is possible in the event of a power failure, then no emergency calls can be made via the communication system following a power failure.
- Before starting wall mounting, check that the wall has sufficient load bearing capacity. Always use suitable installation and mounting materials to mount the communication systems and devices securely.
- Do not allow easily flammable materials to be stored in or near the room where the communication system is installed.

## **1.2.5 Country-specific Safety Information**

Here, you will find information on the specific safety precautions to be observed when installing, starting up and operating the communication systems in certain countries.

### **1.2.5.1 Safety Information for Australia**

The following safety precautions must always be observed when installing, starting up and operating the OpenScape Business X and OpenScape Business S communication systems and the OpenScape Business UC Booster Server (Application Server) in Australia:

- The OpenScape Business X and OpenScape Business S communication systems and the OpenScape Business UC Booster Server (Application Server) must be installed and serviced only by authorized personnel.
- OpenScape Business wall systems must be installed near the mains socket outlet that supplies power to the respective communication system. The wall

socket shall be readily accessible. The integrity of the wall socket must be assured.

- The OpenScape Business X and OpenScape Business S communication systems and the OpenScape Business UC Booster Server (Application Server) must be configured to allow emergency calls (for example, 000) to be made at all times.
- If no emergency backup power supply is available or if no switchover to emergency analog phones (trunk failure transfer) is possible in the event of a power failure, then no emergency calls can be made via the communication system following a power failure).
- Music on Hold and paging devices must be connected to the communication system via a Line Isolation Unit approved by the Australian Communications Authority (ACA).

### **1.2.5.2 Safety Information for Brazil**

The following safety precautions must always be observed when installing, starting up and operating the OpenScape Business X and OpenScape Business S communication systems and the OpenScape Business UC Booster Server (Application Server) in Brazil:

- The use of the outlet strip with overvoltage protection with part number C39334-Z7052-C33 is absolutely mandatory. The power supply of the OpenScape Business X and OpenScape Business S communication systems and the OpenScape Business UC Booster Server (Application Server) must be passed through an outlet strip with overvoltage protection.
- The use of shielded Ethernet cables for the LAN/WAN interfaces/ports of the OCCL, OCCM and OCCMR mainboards and the UC Booster Card OCAB (Application Board) is absolutely mandatory.

### **1.2.5.3 Safety Information for the U.S.**

The following safety precautions must always be observed when installing, starting up and operating the OpenScape Business X and OpenScape Business S communication systems and the OpenScape Business UC Booster Server (Application Server) in the United States:

- **Disruption of the Network and T1**  
When communication systems are networked using T1 (1.544 Mbit/s), the telecommunications company (Federal Communications Commission (FCC)) must be notified whenever a communication system is removed from the grid. If any of the communication systems of Unify Software and Solutions GmbH & Co. KG described in this documentation disrupts the operation of the public telecommunications network, the telecommunications company is entitled to temporarily block access to the outside line. In general, the telecommunications company will inform you about this in advance. If this is not possible, you will receive notification at the earliest possible time. In this context, you will also be informed that you can lodge a complaint with the telecommunications company.

- **Telephone Company Facility Changes**  
The telecommunication company is entitled to adapt its own equipment, devices, operating procedures, and processes as necessary; Such modifications may impair the operation of your communication systems. Under normal circumstances, you should be notified in advance so you can maintain uninterrupted telephone service.
- **Nonlive Voice Equipment**  
Nonlive voice equipment, such as music-on-hold devices and voice recorders must be approved and released by Unify Software and Solutions GmbH & Co. KG and registered in accordance with the rules and regulations of Subpart C of the FCC Rules, Part 68.  
Unreleased devices for voice playback may only be connected through protective circuitry that is approved and released by Unify Software and Solutions GmbH & Co. KG and registered in accordance with the rules and regulations in Subpart C of the FCC Rules, Part 68.
- **Ringer Equivalence Number REN**  
The Ringer Equivalence Number (REN) is used to determine the number of devices that can be connected to a telephone line so that all the devices ring when that telephone number is called. In most areas, but not all, the sum of the RENs of all devices connected to a line should not exceed five. Contact the local telecommunication company to determine the maximum REN for your calling area.
- **New Local Area and CO Access Codes**  
Least Cost routing (LCR) must be configured to automatically recognize and take changes in local area codes and CO access codes into account. Otherwise, these codes will not be usable for calls when changes occur.
- **Hearing Aid Compatibility**  
Emergency phones and public phones (installed in common areas such as lobbies, hospital rooms, elevators, and hotel rooms, for example) must have handsets that are compatible with magnetically coupled hearing aids. Hearing-impaired individuals who are not in common areas must be provided with hearing-aid compatible handsets, if needed.  
All digital phones from Unify Software and Solutions GmbH & Co. KG manufactured after August 16, 1989, are hearing aid compatible and comply with FCC Rules, Part 68, Section 68.316.
- **Programmed Dialer features**  
When you program emergency numbers or make test calls to emergency numbers with programmed dialer features using products by Unify Software and Solutions GmbH & Co. KG, stay on the line and briefly explain to the dispatcher the reason for the call before hanging up. These activities should be performed during off-peak hours, such early morning or late evening.
- **Connecting Off-Premises Station Facilities**  
Customers who intend to connect off-premises station (OPS) facilities must inform the telecommunications company of the OPS class for which the equipment is registered and the connection desired.
- **Direct Inward Dialing Answer Supervision**  
Customers who operate any of the communication systems from Unify Software and Solutions GmbH & Co. KG described in this documentation

without providing proper answer supervision are in violation of Part 68 of the FCC rules.

Every communication system of Unify Software and Solutions GmbH & Co. KG described in this documentation returns proper answer supervision to the public switched telephone network (PSTN) when DID calls are:

- answered by the called station.
- answered by an attendant.
- routed to an announcement administered by the customer.

In addition, every communication system of Unify Software and Solutions GmbH & Co. KG described in this documentation also returns proper answer supervision on all DID calls forwarded to the PSTN. Permissible exceptions are when:

- A call is not answered.
- A busy tone is received.
- A congestion tone (reorder tone) is received.

- **Equal Access Requirements**

Call aggregators with an increased volume of traffic (such as hotels, hospitals, airports, schools, and so on) must provide end users equal access to the providers of their choice. The current equal access codes (also known as Carrier Access Codes, CACs) are 10xxx and 101xxxx, and 800/888 and 950, where xxx or xxxx represents the provider code.

To select the provider of choice for a call, the user dials a provider-specific access code before dialing the called party number. Equal access is also obtained by dialing the 800/888 or 950 code of the provider of choice.

Every communication system of Unify Software and Solutions GmbH & Co. KG described in this documentation is capable of providing user access to interstate providers through the use of equal access codes.

Modifications by aggregators to alter these capabilities are a violation of the Telephone Operator Consumer Services Improvement Act of 1990 and Part 68 of the FCC Rules.

## 1.2.5.4 Safety Information for Canada



---

### **DANGER**

#### **Risk of electric shock through contact with live wires**

Only personnel with proper qualifications or qualified electricians should perform work on the low-voltage network (<1000 VAC) and all work must comply with the national/local requirements for electrical connections.

---

The following safety precautions must always be observed when installing, starting up and operating the OpenScape Business X and OpenScape Business S communication systems and the OpenScape Business UC Booster Server (Application Server) in Canada:

- Ringer Equivalence Number REN  
The Ringer Equivalence Number (REN) defines how many devices can be connected to a telephone line at the same time. The termination of an interface may consist of any combination of devices subject only to the requirement that the sum of the RENs of all the devices does not exceed five.
- Restrictions for connecting devices  
The Industry Canada label identifies certified equipment. This certification means that the equipment meets certain requirements with regard to the protection, operation and security of telecommunication networks. The requirements are documented in the Terminal Equipment Technical Requirements. Industry Canada provides no assurances that certified devices will always operate to the satisfaction of the customer.  
Before installing the equipment and components described in this documentation, it must be ensured that connections to the facilities of the local telecommunications company are permitted. The communication systems and servers must also be installed using an acceptable method of connection. The customer should be aware that compliance with these conditions may not prevent degradation of performance in some situations. Repairs to certified equipment should be coordinated by a service technician designated by the manufacturer or supplier. Any repairs or alterations made by the user to any of the equipment or components described in this documentation, or any equipment malfunctions, may give the telecommunications company cause to request the user to disconnect the equipment.  
To ensure their own safety, users must verify that the electrical ground connections of the power supply, telephone lines and the metallic water pipe system, if present, are interconnected. This precaution may be particularly important in rural areas.

## 1.3 Important Notes

The important notes inform you about emergency procedures and the proper disposal, recycling, intended use and operating conditions of the communication systems and servers. In addition, they also include details concerning the standards and guidelines for the installation, the radio interference characteristics of the communication systems, and data protection and data security.

### 1.3.1 Emergencies

This section provides information on how to proceed in an emergency.

#### What To Do In An Emergency

- In the event of an accident, remain calm and controlled.
- Always switch off the power supply before you touch an accident victim.
- If you are not able to immediately switch off the power supply, only touch the victim with non-conductive materials (such as a wooden broom handle), and first of all try to isolate the victim from the power supply.



### **First Aid**

- Be familiar with basic first aid procedures for electrical shock. A fundamental knowledge of the various resuscitation methods if the victim has stopped breathing or if the victim's heart is no longer beating, as well as first aid for treating burns, is absolutely necessary in such emergencies.
- If the victim is not breathing, immediately perform mouth-to-mouth or mouth-to-nose resuscitation.
- If you have appropriate training, immediately perform heart massage if the victim's heart is not beating.

### **Calling for Help**

Immediately call an ambulance or an emergency physician. Provide the following information in the following sequence:

- Where did the accident happen?
- What happened?
- How many people were injured?
- What type of injuries?
- Wait for questions.

### **Reporting Accidents**

- Immediately report all accidents, near accidents and potential sources of danger to your manager.
- Report all electrical shocks, no matter how small.

## **1.3.2 Proper Use**

The communication systems and servers may only be used as described in this documentation and only in conjunction with add-on devices and components recommended and approved by Unify Software and Solutions GmbH & Co. KG.

The prerequisites for the proper use of the communication systems and servers include proper transportation, storage, installation, startup, operation and maintenance of the system.

---

**INFO:** Clean the housing of the communication system and server only with a soft, slightly damp cloth. Do not use any abrasive cleaners or scouring pads.

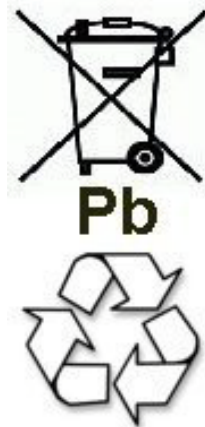
---

## **1.3.3 Correct Disposal and Recycling**

Please read the information on the correct disposal and recycling of electrical and electronic equipment and old batteries.



All electrical and electronic products should be disposed of separately from the municipal waste stream via designated collection facilities appointed by the government or the local authorities. The correct disposal and separate collection of your old appliance will help prevent potential negative consequences for the environment and human health. It is a precondition for reuse and recycling of used electrical and electronic equipment. For more detailed information about disposal of your old appliance, please contact your city office, waste disposal service, the shop where you purchased the product or your sales representative. The statements quoted above are only fully valid for equipment which is installed and sold in the countries of the European Union and is covered by the directive 2002/96/EC. Countries outside the European Union may have other regulations regarding the disposal of electrical and electronic equipment.



Old batteries that bear this logo are recyclable and must be included in the recycling process. Old batteries that are not recycled must be disposed of as hazardous waste in compliance with all regulations.

## 1.3.4 Installation Standards and Guidelines

This section provides information on the specifications you must comply with when connecting the communication systems and servers to the power supply circuit and when using shielded cabling for LAN and WAN connectors.

### 1.3.4.1 Connecting OpenScape Office X to the Power Supply Circuit

The OpenScape Business X communication systems have been approved for connection to TN-S power supply systems. They can also be connected to a TN-C-S power supply system in which the PEN conductor is divided into a ground wire and a neutral wire. TN-S and TN-C-S systems are defined in the IEC 364-3 standard.

Only qualified electricians should perform any work that may be required on the low-voltage network. These installation activities to connect the communication

systems must be performed in compliance with IEC 60364-1 and IEC 60364-4-41 or any corresponding legal norms or national regulations.

### **1.3.4.2 Connecting OpenScape Business S and OpenScape Business UC Booster Server to the Power Supply Circuit**

For information regarding the connection of OpenScape Business S and OpenScape Business UC Booster Server (Application Server) to the power supply circuit, please refer to the manufacturer's documentation for the server PC and the other components.

Only qualified electricians should perform any work that may be required on the low-voltage network. These installation activities to connect OpenScape Business S and the OpenScape Business UC Booster Server must be performed in compliance with IEC 60364-1 and IEC 60364-4-41 or any corresponding legal norms or national regulations (for example in the U.S. and in Canada).

### **1.3.4.3 Shielded Cabling for LAN and WAN Connections of OpenScape Business X**

Compliance with CE requirements on electromagnetic compatibility in the OpenScape Business X communication systems and their LAN and WAN connections is subject to the following conditions:

- The communication systems should only be operated using shielded connection cables. This means that a shielded Category 5 (CAT.5) cable with a length of at least 3 m should be used between the shielded LAN and WAN sockets of the communication systems and the building installation port or the external active component port. The cable shield must be grounded at the building installation end or the external active component end (connection to the building's potential equalization terminal).
- A shielded Category 5 (CAT.5) cable should also be used for shorter connections with external active components (LAN switch or similar). However, the active component must feature a shielded LAN connection with a grounded shield connection (connection to the building's potential equalization terminal).
- The shield properties of the cable components should at least satisfy the requirements of the European standard EN 50173-1<sup>\*)</sup> "Information technology - Generic cabling systems" (and all references specified).<sup>\*\*\*)</sup>
- Building installations that are fitted with shielded symmetrical copper cables throughout in accordance with the Class-D requirements<sup>\*\*)</sup> of EN 50173-1 satisfy the above condition.<sup>\*\*\*)</sup>

<sup>\*)</sup> The European standard EN 50173-1 is derived from the international standard ISO/IEC 11801.

<sup>\*\*)</sup> Class-D is reached, for instance, if Category-5 (CAT.5) components (cables, wall outlets, connection cables, etc.) are installed.

\*\*\*) UTP cables (U.S. standard EIA/TIA 568 T) are the most widely used cables on the North American market; this has the following implications for the LAN and WAN connections in communication systems: The systems may only be operated with shielded connection cables. This means that a shielded Category 5 (CAT.5) cable with a length of at least 3 m should be used between the shielded LAN and WAN sockets of the communication systems and the building installation port or the external active component port. The cable shield must be grounded at the building installation end or the external active component end (connection to the building's potential equalization terminal).

### 1.3.4.4 Fire Safety Requirements

Fire safety requirements are defined on a country-specific basis in the building regulations. Please follow the valid regulations for your country.

To ensure the legal fire protection and EMC requirements, operate the OpenScape Business X communication systems only when closed. The system may only be opened temporarily for installation and maintenance purposes.

OpenScape Business system cables comply with the requirements of international norm IEC 60332-1 regarding flammability. The following norms contain similar requirements regarding cables:

<p>IEC 60332-1 Note: IEC 60332-1 is equivalent to test method UL VW-1</p>	<p>EN 50265-1 with EN 50265-2-1 Note: EN 50265-1 and -2-1 replace HD 405.1</p>	<p>VDE 0482 Parts 265-1 with VDE 0482 Parts 265-2-1 Note: VDE 0482 Parts 265-1 and -2-1 replace VDE 0472, Part 804, Test Method B</p>
---	--	---

The division responsible for project planning and service must check whether the IEC 60332-1 norm complies sufficiently with the relevant building regulation and any other applicable regulations.

### 1.3.4.5 Lightning Protection Requirements

The protection of communication systems against high-energy surges requires a low-impedance ground connection in accordance with the specifications in the *OpenScape Business Installation Guide*.

---

**NOTICE:** Once a communication system has been grounded, check the low-impedance ground connection of the system using the ground conductor of the mains power supply circuit and the low-impedance connection (of the additional permanently-connected protective ground conductor) to the building's potential equalization bus.

---

---

**NOTICE:** Fire hazard due to surge voltage

Telecom lines which are over 500m in length or which must leave the building must be conducted through an additional external lightning protection.

Lightning protection of this kind is known as additional primary protection. The additional primary protection is guaranteed by the professional installation of ÜSAGs (surge arresters, gas filled) in the main distribution frame, the patch panel or at the entry point of the pipe in the building. A gas-filled surge arrester with 230 V nominal voltage is switched to ground from each wire that is to be protected.

Without this additional primary protection, lightning could irreparably damage the boards. This can cause the entire communication system to fail or result in components overheating (Fire hazard).

---

### 1.3.4.6 Markings for OpenScape Business X



The compliance of the equipment according to EU directives is confirmed by the CE mark. This Declaration of Conformity and, where applicable, other existing declarations of conformity as well as further information on regulations that restrict the usage of substances or affect the declaration of substances used in products can be found in the Unify Expert WIKI at <http://wiki.unify.com> under the section "Declarations of Conformity".

### 1.3.5 Notes on Electromagnetic and Radio Frequency Interference of OpenScape Business X

The OpenScape Business X communication systems are Class B devices in accordance with EN 55022.

### 1.3.6 Data Protection and Data Security

Please note the details below with respect to protecting data and ensuring privacy.

The communication systems and servers described in this documentation process and use personal data for purposes such as call detail recording, displays, and customer data acquisition.



In Germany, the processing and use of such data is subject to various regulations, including those of the Federal Data Protection Law (Bundesdatenschutzgesetz, BDSG). For other countries, please follow the appropriate national laws.

The aim of data protection is to protect the rights of individuals from being adversely affected by use of their personal data.

In addition, the aim of data protection is to prevent the misuse of data when it is processed and to ensure that one's own interests and the interests of other parties which need to be protected are not affected.

---

**INFO:** The customer is responsible for ensuring that the communication systems and servers are installed, operated and maintained in accordance with all applicable labor laws and regulations and all laws and regulations relating to data protection, privacy and safe labor environment.

---

Employees of Unify Software and Solutions GmbH & Co. KG are bound to safeguard trade secrets and personal data under the terms of the company's work rules.

In order to ensure that the statutory requirements are consistently met during service – whether on-site or remote – you should always observe the following rules. You will not only protect the interests of your and our customers, you will also avoid personal consequences.

A conscientious and responsible approach helps protect data and ensure privacy:

- Ensure that only authorized persons have access to customer data.
- Take full advantage of password assignment options; never give passwords to an unauthorized person orally or in writing.
- Ensure that no unauthorized person is able to process (store, modify, transmit, disable, delete) or use customer data in any way.
- Prevent unauthorized persons from gaining access to storage media such as backup CDs and DVDs or log printouts. This applies to service calls as well as to storage and transport.
- Ensure that storage media which are no longer required are completely destroyed. Ensure that no sensitive documents are left unprotected.
- Work closely with your customer contact; this promotes trust and reduces your workload.

## 1.3.7 Technical Regulations and Conformity of OpenScape Business X

Details on how the OpenScape Business X communication systems meet conformity requirements can be found here.

### 1.3.7.1 CE Conformity

CE certification is based on the R&TTE Directive 99/5/EEC.

	<b>Standards reference</b>
Safety	EN 60950-1
Electromagnetic Compatibility EMC	EN55022 (EMC Emission) EN55024 (EMC Immunity Residential)
Digital Enhanced Cordless Telecommunications (DECT)	ETS 300 329 (DECT Emission/Immunity) TBR 06, ETS 301489-1/6 (DECT Air Interface)

### 1.3.7.2 Conformity with US and Canadian Standards

	<b>Standards reference</b>
Safety USA	UL 60950-1
Safety Canada	CSA C22.2 No. 60950-1-03
EMC Emission	FCC Part 15 Subpart J Class B

#### **FCC Registration Number and Power Consumption**

A label on the rear of the housing of the communication systems identifies the FCC registration number, the ringer equivalence number (REN), and other information. Upon request, this information may be disclosed to the telecommunication company.

### 1.3.7.3 Conformity with International Standards

	<b>Standards reference</b>
Safety	IEC 60950-1

## 1.3.8 Operating Conditions

Note the environmental and mechanical conditions for operating the OpenScape Business X and OpenScape Business S communication systems and the OpenScape Business UC Booster Server (Application Server).

### 1.3.8.1 Operating Conditions for OpenScape Business X

The environmental and mechanical conditions for operating the OpenScape Business X communication systems are specified.

### Environmental Operating Conditions

Operating limits:

- Room temperature: + 5 to + 40 °C (41 to 104 °F)
- Absolute humidity: 1 to 25 g H<sub>2</sub>O/m<sup>3</sup>
- Relative humidity: 5 to 80%

Ventilation of the communication systems is by convection only. Forced ventilation is required for OpenScape Business X5W when using more than 32 a/b interfaces.

---

**NOTICE:** Damage caused by local temperature increases  
Avoid exposing the communication systems to direct sunlight and other sources of heat.

---

---

**NOTICE:** Damage caused by condensation due to humidity  
Avoid any condensation of humidity on or in the communication systems before or during operation under all circumstances.  
A communication system must be completely dry before you put it into service.

---

### Mechanical Operating Conditions

The communication systems are intended for stationary use.

## 1.3.8.2 Operating Conditions for OpenScape Business S and OpenScape Business UC Booster Server

For details on the environmental and mechanical conditions for operating OpenScape Business S and OpenScape Business UC Booster Server (Application Server), please also refer to the manufacturer documentation of the server PCs and the other components.

## 2 Communication Systems

The various communication systems of the OpenScape Business communications platform offer a high degree of flexibility in terms of functionality and design.

### Overview of Communication Systems

- **OpenScape Business X3R**  
Communication system which comes in a 19-inch rack housing and can be installed in a 19-inch rack, as a standalone unit (desktop operation) or wall mounted.
- **OpenScape Business X3W**  
Communication system which comes in a wall housing and must be wall mounted.
- **OpenScape Business X5R**  
Communication system which comes in a 19-inch rack housing and can be installed in a 19-inch rack, as a standalone unit (desktop operation) or wall mounted.
- **OpenScape Business X5W**  
Communication system which comes in a wall housing and must be wall mounted.
- **OpenScape Business X8**  
Modular communication system which can be used as a one-box system (base box) or two-box system (base box + expansion box). OpenScape Business X8 can be installed as a standalone unit or mounted in a 19-inch rack.
- **OpenScape Business S**  
Softswitch (software-based UC solution) that is platform-independent and can be operated on a Linux server.  
For information on OpenScape Business S, please refer to the *OpenScape Business, Administrator Documentation* and the *OpenScape Business S, Installation Guide*.

For information on the OpenScape Business UC Booster Server (Application Server), please refer to the *OpenScape Business, Administrator Documentation* and the *OpenScape Business X3/X5/X8, Installation Guide*

### 2.1 OpenScape Business X3R

The OpenScape Business X3R is a communication system in a 19-inch rack mount case that can be mounted in a 19-inch rack, as a standalone unit (desktop operation) or as a wall-mounted unit.

**Figure:** OpenScape Business X3R



OpenScape Business X3R has three slot levels, which are equipped as follows:

- Slot level 1: slots for two peripheral boards
- Slot level 2: slot for the OCCMR mainboard
- Slot level 3: slots for three options

The front panel of the mainboard provides several RJ45 jacks for connecting telephones, trunks, LAN switches, etc.

The power supply (OCPSM) is located in the rear part of the 19" rack housing. No further components are required for permanent AC power supply operation. To maintain short-term battery emergency operation after a power failure, that is, to use uninterruptible power supply functions, an UPS should be connected.

#### **Construction data**

- Dimensions (height x width x depth): approx. 88 mm x 440 mm x 380 mm
- Height units 19" rack-mount installation: 2
- Weight: approx. 6 kg

## **2.2 OpenScape Business X3W**

OpenScape Business X3W is a communication system which can be wall mounted.

**Figure:** OpenScape Business X3W



OpenScape Business X3W includes a board shelf with three slot levels, which are equipped as follows:

- Slot level 1: slots for two peripheral boards
- Slot level 2: slot for the OCCM mainboard
- Slot level 3: slots for five options

The connection of telephones, CO trunks, etc., can be made directly at the boards or via an external main distribution frame.

The back of the board frame has the power supply (OCPSM). No further components are required for permanent AC power supply operation. To maintain short-term battery emergency operation after a power failure, that is, to use uninterruptible power supply functions, an UPS should be connected.

#### **Construction data**

- Dimensions (height x width x depth): approx. 450 mm x 460 mm x 128 mm
- Weight: approx. 6 kg

## **2.3 OpenScape Business X5R**

The OpenScape Business X5R is a communication system in a 19-inch rack mount case that can be mounted in a 19-inch rack mount cabinet, as a standalone unit (desktop operation) or as a wall-mounted unit.

**Figure:** OpenScape Business X5R



OpenScape Business X5R has five slot levels, which are equipped as follows:

- Slot levels 1 through 3: each slot level provides slots for two peripheral boards
- Slot level 4: slot for the OCCMR mainboard
- Slot level 5: slots for three options

The front panel of the mainboard provides several RJ45 jacks for connecting telephones, trunks, LAN switches, etc.

The power supply (OCPSM) is located in the rear part of the 19" rack housing. No further components are required for permanent AC power supply operation. To maintain short-term battery emergency operation after a power failure, that is, to use uninterruptible power supply functions, an UPS should be connected.

#### **Construction data**

- Dimensions (height x width x depth): approx. 155 mm x 440 mm x 380 mm
- Height units for 19" rack-mount installation: 4
- Weight: approx. 8 kg

## **2.4 OpenScape Business X5W**

OpenScape Business X5W is a communication system that can be wall-mounted.

**Figure:** OpenScape Business X5W



OpenScape Business X5W includes a board shelf with six slot levels, which are equipped as follows:

- Slot levels 1 through 3: each slot level provides slots for two peripheral boards
- Slot level 4: slot for the OCCM mainboard
- Slot level 6: slots for five options

---

**INFO:** Slot level 5 is no longer available in X5W systems with OCPSM power supply.

---

The connection of telephones, CO trunks, etc., can be made directly at the boards or via an external main distribution frame.

The back of the board frame has the power supply (OCPSM). No further components are required for permanent AC power supply operation. To maintain short-term battery emergency operation after a power failure, that is, to use uninterruptible power supply functions, an UPS should be connected.

**Construction data**

- Dimensions (height x width x depth): approx. 450 mm x 460 mm x 200 mm
- Weight: approx. 8 kg

## 2.5 OpenScape Business X8

OpenScape Business X8 is a modular communication system that can be used as a one-box system (base box) or a two-box system (base box + expansion box).



OpenScape Business X8 can be installed as a standalone unit or mounted in a 19-inch rack.

**Figure:** OpenScape Business X8



The base box has nine slots and the expansion box has thirteen slots for peripheral boards.

The central control board OCCL has a fixed slot (slot 6, only in the base box).

Depending on your requirements, up to three LUNA2 power supply units can be used in the base box and up to four in the expansion box. LUNA2 supports power supply and battery management functions. No other components are required if it is operated as a power supply. To maintain short-term battery emergency operation after a power failure, that is, to use uninterruptible power supply functions, you must also connect the OpenScape Business Powerbox for each system box.

There are several options for connecting phones, CO trunks, etc. with OpenScape Business X8:

- SIVAPAC connectors are available on the backplane for connecting the external main distribution frame MDFU-E or an external patch panel using CABLUs (prefabricated cabling units).
- Connector panels with 24 RJ45 jacks for direct connection of telephones, trunks, etc. The connector panels are clipped onto the SIVAPAC connectors on the backplane.
- For U.S. only: Connector panels with CHAMP jacks for connecting the external main distribution frame MDFU-E or external patch panels using CABLUs. The connector panels are clipped onto the SIVAPAC connectors on the backplane.

The type of connection used will be decided in consultation with the customer on conclusion of the agreement. The system boxes will be delivered accordingly with or without clipped-on connector panels.

**Construction data**

- Dimensions (height x width x depth): approx. 490 mm x 440 mm x 430 mm
- Height units for 19" rack-mount installation: 11
- Weight, including cabinet feet:
  - Base box: approx. 16.5 kg
  - Expansion box: approx. 15 kg

**Ringer Equivalence Number (type plate)**

- Base box:
  - 6 A / 110 VAC
  - 3 A / 230 VAC
  - 50 - 60 Hz
- Expansion box:
  - 8 A / 110 VAC
  - 4 A / 230 VAC
  - 50 - 60 Hz

## 3 Boards

Boards are differentiated on the basis of their respective functionality as central boards, peripheral boards and options.

Central boards include the mainboard, for example, on which all central control and switching operations of a communication system are executed, the UC Booster Card (Application Board), for the provision of unified communications and collaboration (UC Suite), and the power supplies.

Peripheral boards include trunk boards, subscriber line modules, Cordless boards, tie-traffic boards and the Xpressions Compact boards. Peripheral boards provide interfaces for the connection of telephones, CO trunk and tie lines, DECT base stations, etc. In addition, boards are available for the Xpressions Compact-based Voicemail service.

Options include actuators and sensors for control and monitoring purposes and provide announcements and music on hold (MOH).

### 3.1 Overview of Modules

All boards that are either built in into the base box of a OpenScape Business communication systems or that can be ordered as an expansion are listed below by their function.

#### **Boards within the current portfolio**

These boards can actually be ordered separately or only in combination with a system box.

A distinction between the types of boards according to the explanation above is made:

- Central boards
- Peripheral boards
- Options

#### **Boards and Devices Being Phased Out**

These boards and devices can no longer be ordered. However, they can still be used in the communication systems of the OpenScape Business communication platform.

#### **Non-Supported Boards**

These boards cannot be used in the communication systems of the OpenScape Business communication platform for technical reasons.

These boards must be removed when migrating from HiPath 3000 to OpenScape Business. If required, the respective follow-up board can be used instead.

Refer to the topic *Migration* in the *OpenScape Business Administrator Documentation* for detailed information on the boards that are not supported:

### 3.1.1 Central Boards

All central boards that can be ordered for the communication systems, either separately or in combination with the system box, of the OpenScape Business communication platform are listed below.

---

**NOTICE:** Only the power supply units listed in the table below and those listed under *Boards being phased out* (see *OpenScape Business, Administrator Documentation, Migration*) ensure the safe operation of all communication systems of the OpenScape Business communication platform. Any power supply units not listed there must be replaced.

---

**Table:** Central Boards

Board	Part Number	Used in	Function
CMA	S30807-Q6931-X1	X3R X3W X5R X5W	Provisioning of ADPCM conversion and echo cancellation for DECT Light (integrated cordless solution)
CMAe	S30807-Q6957-X	X3R X3W X5R X5W	Provisioning of ADPCM conversion and echo cancellation for DECT Light (integrated cordless solution)
CUC	S30777-Q750-X	X5W	Backplane
CUCR	S30777-Q750-Z	X5R	Backplane
CUP	S30777-Q751-X	X3W	Backplane
CUPR	S30777-Q751-Z	X3R	Backplane
CUX3R	S30804-Q5395-Z	X3R	Backplane
CUX3W	S30804-Q5394-X	X3W	Backplane
CUX5R	S30804-Q5397-Z	X5R	Backplane
CUX5W	S30804-Q5396-X	X5W	Backplane
DBSAP	S30807-Q6722-X	X8	HDLC, PCM and clock signals are sent from the base box to the expansion box.
LUNA2	S30122-H7686-X1	X8	Power supply unit

Board	Part Number	Used in	Function
OCAB	S30807-K6950-X	X3R X3W X5R X5W X8	Provisioning of Unified Communications and Collaboration for the UC Suite and ensuring that the requirements for the Open Directory Service, OpenStage Gate View (with up to two cameras) and the connection of external applications to the CSTA are met
OCCB1	S30807-Q6949-X100	X3R X3W X5R X5W X8	Addition of one digital signal processor (DSP) for further DSP channels
OCCB3	S30807-Q6949-X	X3R X3W X5R X5W X8	Addition of three digital signal processors (DSPs) for further DSP channels
OCCL	S30810-Q2962-X	X8	Mainboard (central control board) with one WAN and two LAN interfaces
OCCM	S30810-K2959-X	X3W X5W	Mainboard (central control board) with one WAN and two LAN interfaces, 8 U <sub>P0/E</sub> and 4 a/b subscriber line interfaces and 2 S <sub>0</sub> trunk/subscriber line interfaces
OCCMR	S30810-K2959-Z	X3R X5R	Mainboard (central control board) with one WAN and two LAN interfaces, 8 U <sub>P0/E</sub> and 4 a/b subscriber line interfaces and 2 S <sub>0</sub> trunk/subscriber line interfaces
OCPSM	S30122-H7757-X	X3R X3W X5R X5W	Power supply unit
UPSC-D	S30122-H5660-X301	X3W X5W	Power supply unit
UPSC-DR	S30122-H7373-X901	X3R X5R	Power supply unit

### 3.1.2 Peripheral boards

All peripheral boards that can be ordered for the communication systems of the OpenScope Business communication platform are listed below.

**Table:** Peripheral Boards

Board	Part Number	Used in	Function
DIUT2	S30810-Q2226-X100	X8	Digital trunk/tie-traffic board with two S <sub>M2</sub> interfaces
SLAV4	S30810-H2963-X100	X3W X5W	Analog subscriber line module with 4 a/b interfaces, supports CLIP
SLAV8	S30810-H2963-X200	X3W X5W	Analog subscriber line module with 8 a/b interfaces, supports CLIP
SLAV8R	S30810-H2963-Z200	X3R X5R	Analog subscriber line module with 8 a/b interfaces, supports CLIP
SLAV16	S30810-H2963-X	X3W X5W	Analog subscriber line module with 16 a/b interfaces, supports CLIP
SLAV16R	S30810-H2963-Z	X3R X5R	Analog subscriber line module with 16 a/b interfaces, supports CLIP
SLCN Not for U.S.:	S30810-Q2193-X300	X8	Cordless board with 16 ports for connecting base stations for the integrated Cordless solution
SLMAV8N	S30810-Q2227-X300	X8	Analog subscriber line module with 8 a/b interfaces, supports CLIP
SLMAV24N	S30810-Q2227-X400	X8	Analog subscriber line module with 24 a/b interfaces, supports CLIP
SLMO8N	S30810-Q2168-X300	X8	Digital subscriber line module with 8 U <sub>P0/E</sub> interfaces
SLMO24N	S30810-Q2168-X400	X8	Digital subscriber line module with 24 U <sub>P0/E</sub> interfaces
SLMU	S30810-Q2344-X100	X8	Digital subscriber line module with 24 U <sub>P0/E</sub> interfaces
SLU8N	S30817-H922-A401	X3W X5W	Digital subscriber line module with 8 U <sub>P0/E</sub> interfaces
SLU8NR	S30817-K922-Z401	X3R X5R	Digital subscriber line module with 8 U <sub>P0/E</sub> interfaces

Board	Part Number	Used in	Function
STLSX2	S30810-H2944-X100	X3W X5W	Digital trunk or tie-traffic board/ subscriber line module with two S <sub>0</sub> interfaces
STLSX4	S30810-H2944-X	X3W X5W	Digital trunk or tie-traffic board/ subscriber line module with two S <sub>0</sub> interfaces
STLSX4R	S30810-K2944-Z	X3R X5R	Digital trunk or tie-traffic board/ subscriber line module with two S <sub>0</sub> interfaces
STMD3	S30810-Q2217-X10	X8	Digital trunk or tie-traffic board/ subscriber line module with eight S <sub>0</sub> interfaces
TCAS-2 For selected countries only	S30810-Q2945-X	X3W X5W	Digital trunk board with 2 CAS (Channel Associated Signaling) interfaces  For X3W, CUX3W must be used as backplane.
TCASR-2 For selected countries only	S30810-K2945-X	X3R X5R	Digital trunk board with 2 CAS (Channel Associated Signaling) interfaces  For X3R, CUX3R must be used as backplane.
TLANI2	S30810-Q2953-X100	X3W X5W	Analog trunk board with 2 a/b interfaces; supports CLIP and call detail recording with 12/16 kHz pulses
TLANI2 For Brazil only	S30810-Q2953-X182	X3W X5W	Analog trunk board with 2 a/b interfaces, supports CLIP
TLANI4	S30810-Q2953-X	X3W X5W	Analog trunk board with 4 a/b interfaces; supports CLIP and call detail recording with 12/16 kHz pulses
TLANI4 For Brazil only	S30810-Q2953-X82	X3W X5W	Analog trunk board with 4 a/b interfaces, supports CLIP
TLANI4R	S30810-K2953-X200	X3R X5R	Analog trunk board with 4 a/b interfaces; supports CLIP and call detail recording with 12/16 kHz pulses
TLANI4R For Brazil only	S30810-K2953-X282	X3R X5R	Analog trunk board with 4 a/b interfaces, supports CLIP

**Boards**  
Overview of Modules

Board	Part Number	Used in	Function
TLANI8	S30810-H2954-X100	X3W X5W	Analog trunk board with 8 a/b interfaces; supports CLIP and call detail recording with 12/16 kHz pulses
TLANI8 For international markets only	S30810-H2954-X101	X3W X5W	Analog trunk board with 8 a/b interfaces, supports CLIP
TLANI8 For Brazil only	S30810-H2954-X182	X3W X5W	Analog trunk board with 8 a/b interfaces, supports CLIP
TMANI	S30810-Q2327-X	X8	Analog trunk board with 8 a/b interfaces; supports CLIP and call detail recording with 12/16 kHz pulses
TMANI For international markets only	S30810-Q2327-X1	X8	Analog trunk board with 8 a/b interfaces, supports CLIP
TMANI For Brazil only	S30810-Q2327-X82	X8	Analog trunk board with 8 a/b interfaces, supports CLIP
TMCAS2 For selected countries only	S30810-Q2946-X	X8	Digital trunk board with 2 CAS (Channel Associated Signaling) interfaces
TMDID For selected countries only	S30810-Q2197-T	X8	Analog trunk board with 8 a/b interfaces, supports direct inward dialing from the central office (CO)
TMEW2	S30810-Q2292-X100	X8	Analog tie-traffic board with 4 E&M interfaces
TS2N Not for U.S.:	S30810-H2913-X300	X3W X5W	Digital trunk/tie-traffic board with one S <sub>2M</sub> interface  For X3W, CUX3W must be used as backplane.



Board	Part Number	Used in	Function
TS2RN Not for U.S.:	S30810-K2913-Z300	X3R X5R	Digital trunk/tie-traffic board with one S <sub>2M</sub> interface  For X3R, CUX3R must be used as backplane.
TST1 For selected countries only	S30810-Q2919-X	X5W	Digital trunk board with 1 T1 interface
TST1R For selected countries only	S30810-K2919-Z	X5R	Digital trunk board with 1 T1 interface

### 3.1.3 Options

All options that can be ordered for the communication systems of the OpenScape Business communication platform are listed below.

**Table:** Options

Option	Part Number	Used in	Function
EXMR	S30122-K7403-T	X3R X3W X5R X5W X8	Enables the connection of an external music source, and thus the provisioning of announcements and music on hold (MOH), A-law version
EXMR	S30122-K7403-T103	X3R X3W X5R X5W X8	Enables the connection of an external music source, and thus the provisioning of announcements and music on hold (MOH), $\mu$ -law version
PFT4	S30777-Q540-X	X8	Switching of up to 4 analog CO trunks to up to 4 analog phones in the event of a power failure
REALS	S30807-Q6629-X	X8	Switchover from an analog trunk to an analog phone in the event of a power failure  Four relays (actuators) for special connections, such as door openers

## Boards

### Overview of Modules

Option	Part Number	Used in	Function
STRB	S30817-H932-A	X3W X5W	Four double-pin, double-throw relays (actuators) are available for special connections, such as door openers  4 control inputs (sensors) for monitoring the status of connected equipment such as motion detectors, for example
STRBR	S30817-H932-Z	X3R X5R	Four double-pin, double-throw relays (actuators) are available for special connections, such as door openers  4 control inputs (sensors) for monitoring the status of connected equipment such as motion detectors, for example
TFE-S	S30122-K7696-T313	X3R X3W X5R X5W X8	Adapter box with amplifier for connecting an entrance telephone

### 3.1.4 Boards and Devices Being Phased Out

Some boards and devices are being discontinued and can no longer be ordered. However, it can still be used in the communication systems of the OpenScope Business communication platform.

Whenever you encounter errors in conjunction with one of the boards and devices being discontinued, the follow-up board or device should be used.

Board/Device	Part Number	Used in	Function	Notes / Successor
16SLA	S30810-Q2923-X	X3W X5W	Analog subscriber line module with 16 a/b interfaces	SLAV16 (S30810-H2963-X)
4SLA	S30810-Q2925-X100	X3W X5W	Analog subscriber line module with 4 a/b interfaces	SLAV4 (S30810-H2963-X100)
4SLA	S30810-Q2923-X200	X3W X5W	Analog subscriber line module with 4 a/b interfaces	SLAV4 (S30810-H2963-X100)
8SLA	S30810-Q2925-X	X3W X5W	Analog subscriber line module with 8 a/b interfaces	SLAV8 (S30810-H2963-X200)
8SLA	S30810-Q2923-X100	X3W X5W	Analog subscriber line module with 8 a/b interfaces	SLAV8 (S30810-H2963-X200)

Board/Device	Part Number	Used in	Function	Notes / Successor
8SLAR	S30810-K2925-Z	X3R X5R	Analog subscriber line module with 8 a/b interfaces	SLAV8R (S30810-H2963-Z200)
BS3/1	S30807-H5482-X	X3R X3W X5R X5W X8	Base station for the integrated Cordless solution	BS5 (S30807-U5497-X)
BS3/3	S30807-H5485-X	X5W X8	Base station for the integrated Cordless solution	BS5 (S30807-U5497-X)
BS3/S	X30807-X5482-X100	X3R X3W X5R X5W	Base station for the integrated Cordless solution	BS5 (S30807-U5497-X)
BS4	S30807-U5491-X	X3R X3W X5R X5W X8	Base station for the integrated Cordless solution	BS5 (S30807-U5497-X)
CMA	S30807-Q6931-X	X3R X3W X5R X5W	Submodule for DECT Light	CMAe (S30807-Q6957-X)
DIU2U	S30810-Q2216-X	X8	Digital trunk/tie-traffic board with two T1 interfaces	DIUT2 (S30810-Q2226-X100)
DIUN2	S30810-Q2196-X	X8	Digital trunk/tie-traffic board with two S <sub>M2</sub> interfaces	DIUT2 (S30810-Q2226-X100)
IVMN8	S30122-H7688-X200	X8	Provisioning of HiPath Xpressions Compact, 8 ports	IVM NL (S30122-H7688-X)
IVMNL	S30122-H7688-X	X8	Provisioning of Xpressions Compact, 24 ports	-
IVMP4	S30122-Q7721-X	X3W X5W	Provisioning of Xpressions Compact, 4 ports	-
IVMP4R	S30122-K7721-X	X3R X5R	Provisioning of Xpressions Compact, 4 ports	-
IVMS8N	S30122-Q7379-X200	X3W X5W	Provisioning of Xpressions Compact, 8 ports	-

## Boards

### Overview of Modules

Board/Device	Part Number	Used in	Function	Notes / Successor
IVMS8NR	S30122-K7379-Z200	X3R X5R	Provisioning of Xpressions Compact, 8 ports	-
MMP3R	S30122-K7731-Z	X3R X5R	MP3 player for Music On Hold, A-law version	-
MPPI USB EXM	S30122-X8005-X11	X3R X3W X5R X5W	Provision of MoH (music on hold) and announcements, with audio input for external devices	-
MUSIC plugin module	S30122-K7275-T	X3R X3W X5R X5W X8	Provision of MOH (Music On Hold)	-
PFT4	S30777-Q540-X	X8	Switchover from an analog trunk to an analog phone in the event of a power failure	No follow-up board
RGMOD	S30124-X5109-X	X8	Ring voltage generator	No follow-up board
SLA16N	S30810-Q2929-X100	X5W	Analog subscriber line module with 16 a/b interfaces	No follow-up board
SLA24N	S30810-Q2929-X	X5W	Analog subscriber line module with 24 a/b interfaces	No follow-up board
SLAD16	S30810-Q2957-X	X3W X5W	Analog subscriber line module with 16 a/b interfaces, supports CLIP	SLAV16 (S30810-H2963-X)
SLAD4	S30810-Q2956-X100	X3W X5W	Analog subscriber line module with 4 a/b interfaces, supports CLIP	SLAV4 (S30810-H2963-X100)
SLAD8	S30810-Q2956-X200	X3W X5W	Analog subscriber line module with 8 a/b interfaces, supports CLIP	SLAV8 (S30810-H2963-X200)
SLAD8R	S30810-K2956-X300	X3R X5R	Analog subscriber line module with 8 a/b interfaces, supports CLIP	SLAV8R (S30810-H2963-Z200)
SLC16N Not for U.S.:	S30810-Q2193-X100	X5W	Cordless board with 16 ports for connecting base stations for the integrated Cordless solution	No follow-up board
SLMA	S30810-Q2191-C300	X8	Analog subscriber line module with 24 a/b interfaces	SLMAV24N (S30810-Q2227-X400)
SLMA2	S30810-Q2246-X	X8	Analog subscriber line module with 24 a/b interfaces (requires RGMOD)	SLMAV24N (S30810-Q2227-X400)

Board/Device	Part Number	Used in	Function	Notes / Successor
SLMA8	S30810-Q2191-C100	X8	Analog subscriber line module with 8 a/b interfaces	SLMAV8N (S30810-Q2227-X300)
SLMAE24	S30810-Q2225-X200	X8	Analog subscriber line module with 24 a/b interfaces	SLMAV24N (S30810-Q2227-X400)
SLMAE8	S30810-Q2225-X100	X8	Analog subscriber line module with 8 a/b interfaces	SLMAV8N (S30810-Q2227-X300)
SLMAV24	S30810-Q2227-X200	X8	Analog subscriber line module with 24 a/b interfaces, supports CLIP	SLMAV24N (S30810-Q2227-X400)
SLMAV8	S30810-Q2227-X100	X8	Analog subscriber line module with 8 a/b interfaces, supports CLIP	SLMAV8N (S30810-Q2227-X300)
SLMO2	S30810-Q2168-X10	X8	Digital subscriber line module with 24 U <sub>P0/E</sub> interfaces	SLMO24N (S30810-Q2168-X400)
SLMO24	S30810-Q2901-X	X5W	Digital subscriber line module with 24 U <sub>P0/E</sub> interfaces	No follow-up board
SLMO8	S30810-Q2168-X100	X8	Digital subscriber line module with 8 U <sub>P0/E</sub> interfaces	SLMO8N (S30810-Q2168-X300)
SLU8	S30817-Q922-A301	X3W X5W	Digital subscriber line module with 8 U <sub>P0/E</sub> interfaces	SLU8N (S30817-Q922-A401)
SLU8R	S30817-K922-Z301	X3R X5R	Digital subscriber line module with 8 U <sub>P0/E</sub> interfaces	SLU8NR (S30817-K922-Z401)
STLS2	S30817-Q924-B313	X3W X5W	Digital trunk or tie-traffic board/subscriber line module with two S <sub>0</sub> interfaces	STLSX2 (S30810-H2944-X100)
STLS4	S30817-Q924-A313	X3W X5W	Digital trunk or tie-traffic board/subscriber line module with two S <sub>0</sub> interfaces	STLSX4 (S30810-H2944-X)
STLS4R	S30817-Q924-Z313	X3R X5R	Digital trunk or tie-traffic board/subscriber line module with two S <sub>0</sub> interfaces	STLSX4R (S30810-K2944-Z)
TM2LP	S30810-Q2159-Xxxx	X8	Analog trunk board with 8 a/b interfaces	TMANI (S30810-Q2327-Xxxx)
TMC16	S30810-Q2485-X	X8	Analog trunk board with 16 a/b interfaces	TMANI (S30810-Q2327-Xxxx)

## Boards

### Description of the Boards

Board/Device	Part Number	Used in	Function	Notes / Successor
TMCAS	S30810-Q2938-X	X8	Digital trunk board with 1 CAS (Channel Associated Signaling) interface	TMCAS2 (S30810-Q2946-X)
UPSC-D Only for South Africa	S30122-K5660-M321	X3W X5W	Power supply unit	OCPSM (S30122-H7757-X)
UPSC-DR Only for South Africa	S30122-K7373-M921	X3R X5R	Power supply unit	OCPSM (S30122-H7757-X)

Please refer to the HiPath 3000/5000 V9 Service Documentation for detailed information on which boards and devices are being discontinued.

## 3.2 Description of the Boards

All boards that can be ordered for the communication systems of the OpenScape Business communication platform are listed below in alphabetical order.

### 3.2.1 CMA/CMAe

CMA (Clock Module ADPCM) and CMAe (Clock Module with ADPCM enhanced) are optional subboards for the central control boards OCCM (OpenScape Business X3W, OpenScape Business X5W) and OCCMR (OpenScape Business X3R, OpenScape Business X5R).

CMA and CMAe are used in combination with DECT Light (integrated cordless solution). The subboard provides the functions for ADPCM conversion and echo cancellation (16 channels for CMA and 48 channels for CMAe). Up to four calls can be conducted per DECT base station. Up to seven DECT base stations can be connected to the  $U_{P0/E}$  interfaces of the central control boards OCCM and OCCMR.

---

**INFO:** If no CMA is installed, a maximum of two calls can be conducted per base station. In this case, ADPCM conversion is performed directly by the DECT base station, but echo cancellation is not directly supported. In case that echo cancellation is required a CMA/CMAe subboard is needed.

---

### Board Variants and their Use

Board	Part Number	Used in		Maximum number
		Communication system	Country	
CMA	S30807-Q6931-X1	OpenScape Business X3R OpenScape Business X3W OpenScape Business X5R OpenScape Business X5W	ROW	1
CMAe	S30807-Q6957-X	OpenScape Business X3R OpenScape Business X3W OpenScape Business X5R OpenScape Business X5W	ROW	1

CMA and CMAe are plugged into the following connector strips on the mainboards:

- OCCM: connector strips X14 and X15, see *OCCM*
- OCCMR: connector strips X21 and X22, see *OCCMR*

---

**NOTICE:** CMA (S30807-Q6931-X1) is being phased out and can no longer be ordered. However, they can still be connected to OpenScape Business X communication systems.

---



---

**NOTICE:** Place the mainboard on a flat, grounded and conducting surface before inserting the CMA or CMAe subboard. Otherwise you may damage the mainboard.

In the default factory state, the CMA subboard has two spacing bolts inserted to ensure the correct positioning of the subboard on the mainboard.

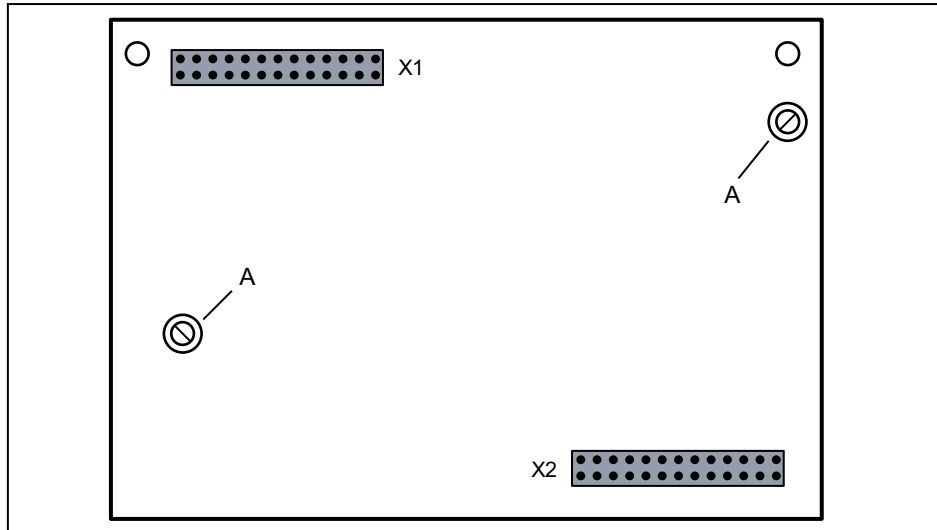
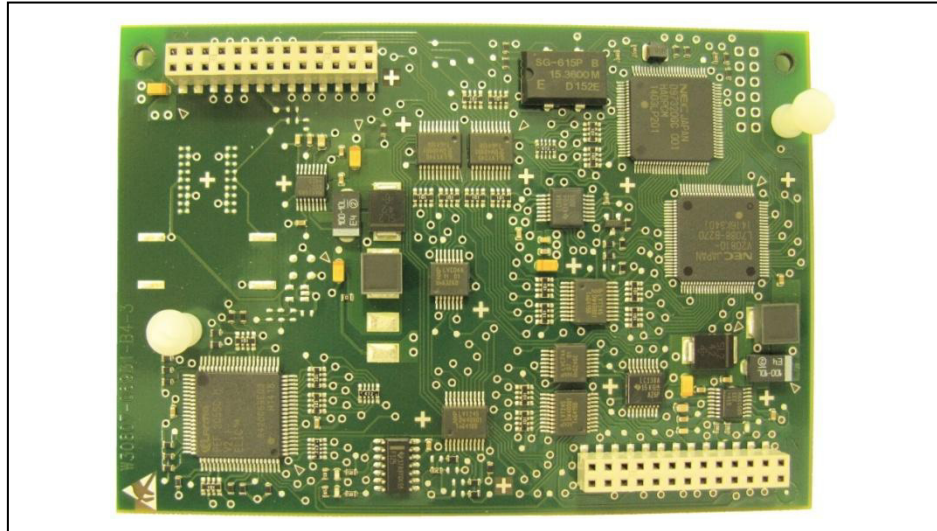
---

**Boards**

Description of the Boards

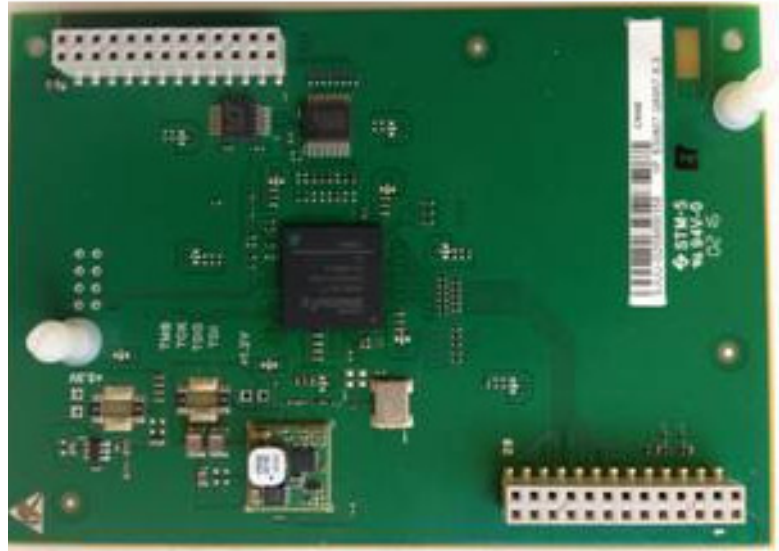
**Figure**

**Figure:** CMA - Component side with inserted spacing bolts (A)





**Figure:** CMAe sybboard



### 3.2.1.1 How to Install CMA or CMAe on OCCM



---

#### **DANGER**

##### **Risk of electric shock through contact with live wires**

Disconnect all power supply circuits of the communication system before opening the housing:

- Disconnect the battery voltage, supply voltage and line voltage at any connected OpenScape Business Powerbox.
  - Disconnect the line cords of any connected battery pack or any connected batteries.
  - Disconnect the power plug of the communication system.
- 

#### ***Step by Step***

- 1) Disconnect all power supply circuits of the communication system.
- 2) Make sure that the communication system is de-energized.
- 3) Loosen the two fixing screws on the housing cover with a slotted screw driver. Hold the housing cover so that it does not fall.

## Boards

### Description of the Boards



4) Remove the housing cover.



---

#### **CAUTION**

##### **Cuts caused by sharp edges on the shielding plate**

Make sure that you only touch the outside of the housing cover. The shielding plate on the inside of the housing cover may have sharp edges which can cause cuts.

---



- 5) Remove the stabilizer cap.
- 6) Pull out the OCCM mainboard from the board shelf and place it on a flat, grounded conductive surface.

---

**INFO:** In the default factory state, the CMA or CMAe subboard already has the spacing bolts inserted.

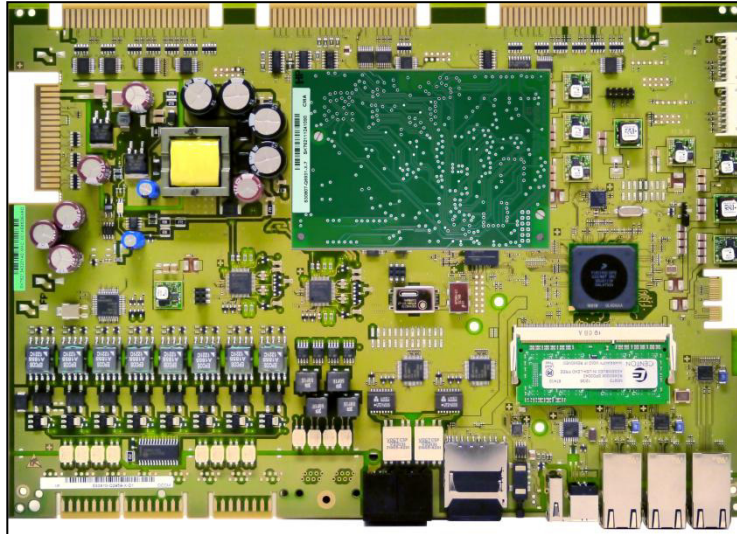
---

- 7) Plug the CMA or CMAe subboard (with component side facing downwards) into the connector strips on the OCCM mainboard. Make sure that the two spacing bolts are plugged into the appropriate holes on the mainboard.

## Boards

### Description of the Boards

**Figure:** CMA mounted on OCCM



- 8) Slide the OCCM mainboard back into the slot that is provided on the board frame for this purpose.
- 9) Mount the stabilizer cap.
- 10) Close the housing. To do this, put the housing cover on and secure it with the two fixing screws. Make sure that you only touch the outside of the housing cover. The shielding plate on the inside of the housing cover may have sharp edges which can cause cuts.
- 11) Place the communication system back into operation.

### 3.2.1.2 How to Install CMA or CMAe on OCCMR



---

#### **DANGER**

##### **Risk of electric shock through contact with live wires**

Disconnect all power supply circuits of the communication system before removing the OCCMR mainboard:

- Disconnect the battery voltage, supply voltage and line voltage at any connected OpenScape Business Powerbox.
  - Disconnect the line cords of any connected battery pack or any connected batteries.
  - Disconnect the power plug of the communication system.
-

### Step by Step

- 1) Disconnect all power supply circuits of the communication system.
- 2) Make sure that the communication system is de-energized.
- 3) Loosen the two locking screws in the front panel of the OCCMR mainboard.
- 4) Loosen the OCCMR mainboard from the backplane using two board wrenches (C39165-A7027-C26).
- 5) Gently pull out the OCCMR mainboard with both hands horizontally from the board shelf and place it on a flat, grounded conductive surface.

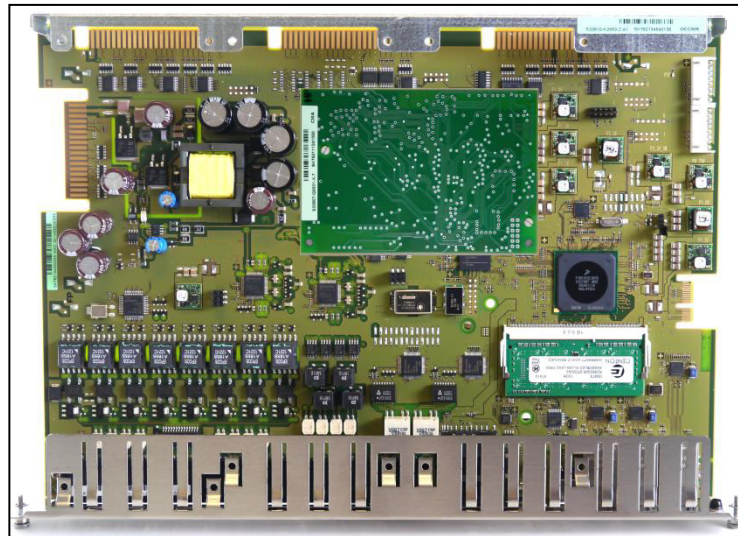
---

**INFO:** In the default factory state, the CMA or CMAe subboard already has the spacing bolts inserted.

---

- 6) Plug the CMA or CMAe subboard (with component side facing downwards) into the connector strips on the OCCMR mainboard. Make sure that the two spacing bolts are plugged into the appropriate holes on the mainboard.

**Figure:** CMA mounted on OCCMR



- 7) Carefully slide the OCCMR mainboard with both hands horizontally back into the slot that is provided on the board frame for this purpose.
- 8) Attach the OCCMR mainboard to the shelf using the two locking screws.
- 9) Place the communication system back into operation.

## 3.2.2 CUX5W

CUX5W (Connection Unit X5W) is the backplane of the OpenScape Business X5W communication system.

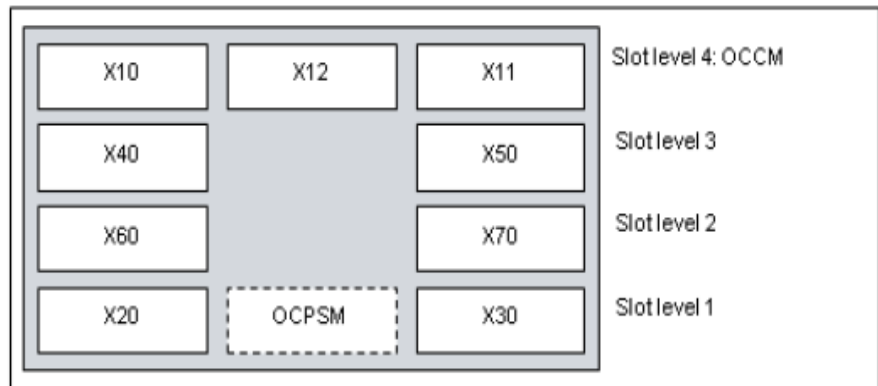
The backplane provides the link between the central control board OCCM (slot level 4), the peripheral boards (slot levels 1-3) and the power supply OCPSM.

**Board Variants and their Use**

Board	Part Number	Used in		Maximum number
		Communication system	Country	
CUX5W	S30804-Q5396-X	OpenScape Business X5W	ROW	1

**Figure**

Figure: CUX5W



**3.2.3 CUX5R**

CUX5R (Connection Unit X5R) is the backplane of the OpenScape Business X5R communication system.

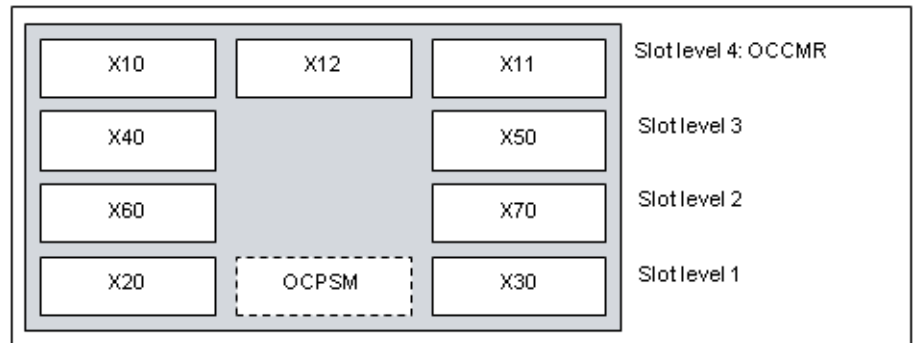
The backplane provides the link between the central control board OCCMR (slot level 4), the peripheral boards (slot levels 1 through 3) and the power supply OCPSM.

**Board Variants and their Use**

Board	Part Number	Used in		Maximum number
		Communication system	Country	
CUX5R	S30804-Q5397-Z	OpenScape Business X5R	ROW	1

**Figure**

**Figure:** CUX5R



### 3.2.4 CUX3W

CUX3W (Connection Unit X3W) is the backplane of the OpenScape Business X3W communication system.

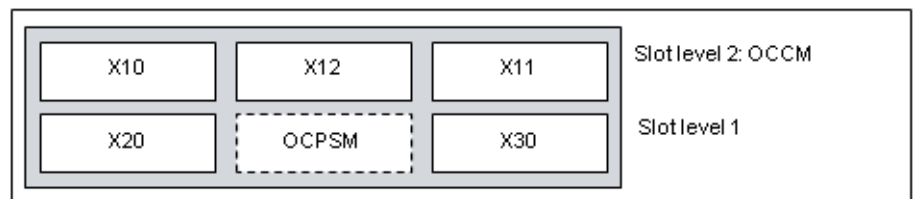
The backplane provides the link between the central control board OCCM (slot level 2), the peripheral boards (slot level 1) and the power supply OCPSM.

**Board Variants and their Use**

Board	Part Number	Used in		Maximum number
		Communication system	Country	
CUX3W	S30804-Q5394-X	OpenScape Business X3W	ROW	1

**Figure**

**Figure:** CUX3W



### 3.2.5 CUX3R

CUX3R (Connection Unit Point X3R) is the backplane of the OpenScape Business X3R communication system.

The backplane provides the link between the central control board OCCMR (slot level 2), the peripheral boards (slot level 1) and the power supply OCPSM.

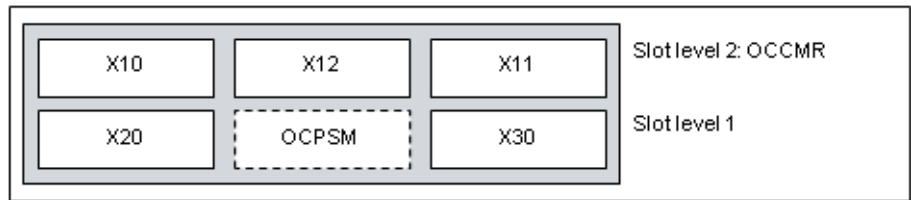


**Board Variants and their Use**

Board	Part Number	Used in		Maximum number
		Communication system	Country	
CUX3R	S30804-Q5395-Z	OpenScape Business X3R	ROW	1

**Figure**

Figure: CUX3R



**3.2.6 DBSAP**

The DBSAP (Driver Board for Synergy Access Platform) is essential for expanding the OpenScape Business X8 communication system to a two-box system. The DBSAP ensures that the expansion box receives HDLC, PCM and clock signals from the base box.

The back of the DBSAP board has four jacks that are plugged into the corresponding backplane connectors of the extension box. The 68-pin DB-68 jack on the front panel is used to connect the C39195-Z7611-A10 connecting cable to the base box.

---

**NOTICE:** To ensure smooth operation, use only shielded connection cables with a maximum length of 1 m.

---

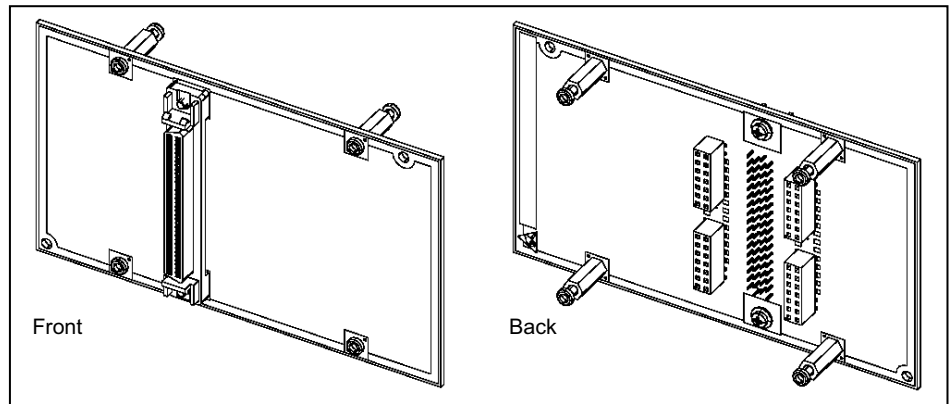
**Board Variants and their Use**

Board	Part Number	Used in		Maximum number
		Communication system	Country	
DBSAP	S30807-Q6722-X	OpenScape Business X8	ROW	1

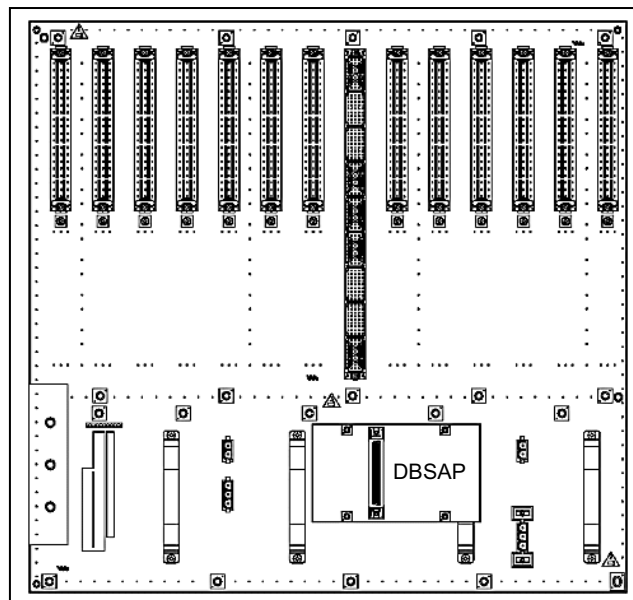


**Figure**

**Figure:** DBSAP



**Figure:** DBSAP – Installation on the Backplane of the Expansion Box



### 3.2.7 DIUT2

The DIUT2 (Digital Interface Unit Trunk 2) board provides two interfaces, which can be used for the trunk connection and for tie-traffic (networking).

The DIUT2 board is a compatible successor to the following boards, which will be discontinued:

- DIU2U (S30810-Q2216-X)
- DIUN2 (S30810-Q2196-X)

**Board Variants and their Use**

Board	Part Number	Used in		Maximum number
		Communication system	Country	
DIUT2	S30810-Q2226-X100	OpenScope Business X8	ROW	3 DIUT2 and/or DIUN2  When used as a T1 trunk connection (PRI or analog), up to four DIUT2 and/or DIU2U boards are possible.

**Usage and Connection Types**

The usage and connection type are defined via the WBM or Manager E. The settings always apply to both board interfaces. It is not possible to work with different usage connection types at the same time.

The following usage and connection types are available:

- Usage types:
  - S<sub>2M</sub> trunk connection or S<sub>2M</sub> networking
  - For U.S. only: T1-PRI trunk connection
  - For U.S. only: analog T1 trunk connection
- Connection types:
  - Connection via fiber optic cable  
The connection is made via the 15-pin Sub-D jacks on the front panel. The opto-electronic converter AMOM must be used to connect a fiber optic cable.
  - Connection via copper cable (system cable S30267-Z167-Axxx)  
The connection is made via the 15-pin Sub-D jacks on the front panel.

After the usage and connection type has been defined, the DIUT2 board automatically performs a reload to load the loadware for the new settings.

---

**INFO:** For U.S. only and when using the board for the T1-PRI trunk connection or the analog T1 trunk connection

The T1 interface must not be directly connected to the PSTN (Public Switched Telephone Network). At least one Channel Service Unit (CSU) that is approved as per FCC Part 68 and that satisfies the ANSI directive T1.403 must be inserted between the T1 interface and the central office.

The CSU provides the following features for OpenScope Business X8: Isolation and overvoltage protection of the communication system, diagnostic options in the event of a malfunction (such as signal loopback, application of test signals and test patterns), line-up of the output signal in compliance with the line lengths specified by the network provider.

---

**Figure**

**Figure:** DIUT2 – Front Panel



**LEDs**

The board features a front panel with two LEDs that indicate the operating states.

**Table:** DIUT2 – LED Statuses and their Meanings

Red LED	Green LED	Meaning	Action
off	off	Board not receiving power or not plugged in correctly. Board is out of order.	Check plug contact on board.
on	off	Board is supplied with power. Board test in progress.	–
		Loadware loading failed. Board is faulty.	Replace board.
		Board was deactivated using Manager E.	Check whether the board was deactivated using Manager E. If not, the board is defective and must be replaced.
flashing	off	Loadware loading in progress.	–
off	on	Loadware loading completed successfully. Board is OK (idle state).	–
off	flashing	At least one channel is activated.	–

**Pin and Cable Assignment**

The front panel includes two 15-pin Sub-D jacks with the following pin assignment.

**Table:** DIUT2 – Pin Assignments of the 15-Pin Sub-D Jacks

Pin	Description	Direction
1	A-wire (copper cable)	Output
4	Data output (fiber optic cable)	Output
5	Ground return path for the +5-V power supply (fiber optic cable)	Input/output
6	Adapter test	Inbox
7	Adapter test	Inbox
8	A-wire (copper cable)	Inbox
9	B-wire (copper cable)	Output
10	5 V power supply (fiber optic cable)	Output
11	Data input (fiber optic cable)	Inbox
12	Ground return path for the +5-V power supply (fiber optic cable)	Input/output
14	5 V power supply (fiber optic cable)	Output
15	B-wire (copper cable)	Inbox
No other pins used.		

**Table:** Pin Assignments of the System Cable S30267-Z167-Axxx

Pin	Description	Color code
1	A-wire, receive	blue/white
8	A-wire, transmit	orange/white
9	B-wire, receive	white/blue
15	B-wire, transmit	white/orange

**Table:** AMOM - Pin Assignments 15-Pin Sub-D Plug

Pin	Description	Direction
4	Data output on the optical fiber interface	Inbox
5	Ground return path for the +5-V power supply	Input/output
6	Adapter test	Output
7	Adapter test	Output
10	+5-V power supply	Inbox
11	Data input on the optical fiber interface	Output

Pin	Description	Direction
12	Ground return path for the +5-V power supply	Input/output
14	+5-V power supply	Inbox
No other pins used.		

### 3.2.8 EXMR

EXMR (Externe Music Connection, Rack) is an optional subboard for the central control boards OCCL (OpenScape Business X8), OCCM (OpenScape Business X3W, OpenScape Business X5W) and OCCMR (OpenScape Business X3R, OpenScape Business X5R).

EXMR enables the connection of an external music source and thus the provisioning of announcements and music on hold (MOH).

There are two subboard variants which both support the A-law or  $\mu$ -law codec for digitizing analog audio signals.

#### Board Variants and their Use

Board	Part Number	Used in		Maximum number
		Communication system	Country	
EXMR A-law version	S30122-K7403-T	OpenScape Business X3R OpenScape Business X3W OpenScape Business X5R OpenScape Business X5W OpenScape Business X8	ROW	1
EXMR $\mu$ -law Version	S30122-K7403-T103	OpenScape Business X3R OpenScape Business X3W OpenScape Business X5R OpenScape Business X5W OpenScape Business X8	ROW	1

## Boards

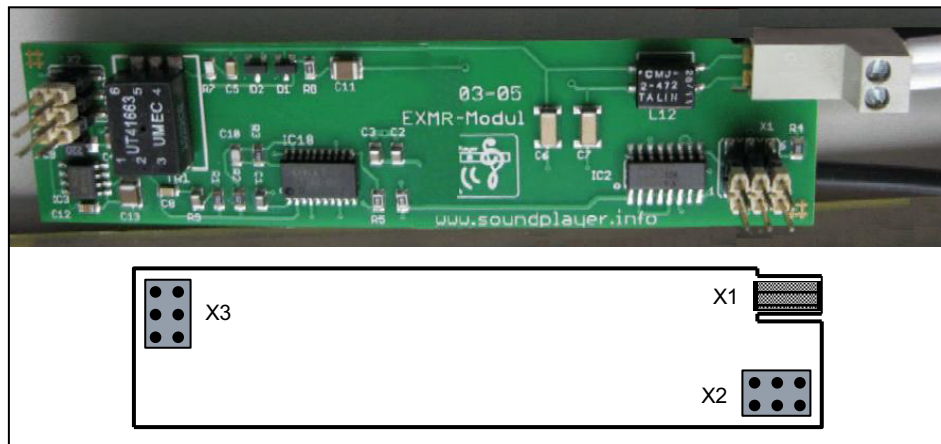
### Description of the Boards

EXMR is plugged into the following socket terminal strips on the mainboards:

- OCCM: socket terminal strips X9 and X10, see [How to Install EXMR on OCCL](#)
- OCCM: socket terminal strips X16 and X17, see [How to Install EXMR on OCCM](#)
- OCCMR: socket terminal strips X23 and X24, see [How to Install EXMR on OCCMR](#)

### Figure

Figure: EXMR



---

**NOTICE:** Place the mainboard on a flat surface before inserting the subboard. Otherwise you may damage the mainboard.

---

### Connecting an External Music Source

The connection of an external music source depends on the communication system.

- OpenScape Business X3R and X5R  
The connection is made via a Wieland screw clamp, which is inserted into the edge connector X1 of the EXMR. The cable is routed to the outside via the RCA jack supplied with the subboard.  
This can be connected to the Sound Player Music Module MP3 Rack (MMP3R, S30122-K7731-Z), for example.
- OpenScape Business X3W and X5W  
The connection is made via a Wieland screw clamp, which is inserted into the edge connector X1 of the EXMR.
- OpenScape Business X8  
The connection is made via a Wieland screw clamp, which is inserted into the edge connector X1 of the EXMR. The cable is routed to the outside via the RCA jack supplied with the subboard.

### 3.2.8.1 How to Install EXMR on OCCL



---

#### **DANGER**

##### **Risk of electric shock through contact with live wires**

Disconnect all power supply circuits of the communication system before removing the OCCL mainboard:

- Disconnect the battery voltage, supply voltage and line voltage at any connected OpenScape Business Powerbox.
  - Disconnect the line cords of any connected battery pack or any connected batteries.
  - Disconnect all power plugs of the communication system.
- 

#### ***Step by Step***

- 1) Disconnect all power supply circuits of the communication system.
- 2) Make sure that the communication system is de-energized.
- 3) Remove the front plastic cover of the base box.
- 4) Insert the tip of the board wrench marked "Pull" into the top opening in the front cover of the OCCL mainboard.
- 5) Lever the OCCL mainboard out of the board shelf of the base box by pushing the board wrench upwards.
- 6) Pull out the OCCL mainboard from the board shelf and place it on a flat, grounded conductive surface.
- 7) Insert the EXMR subboard into the X9 and X10 socket terminal strips of the OCCL mainboard.
- 8) Using its guide rails, slide the OCCL mainboard back into the appropriate slot on the base box shelf.
- 9) Insert the tip of the board wrench marked "Plug-In" into the bottom opening in the front cover of the OCCL mainboard.
- 10) Lever the mainboard into the board shelf of the base box by pushing the board wrench upwards.
- 11) Close the base box with the plastic cover provided for this purpose.
- 12) Place the communication system back into operation.

### 3.2.8.2 How to Install EXMR on OCCM



---

**DANGER**

**Risk of electric shock through contact with live wires**

Disconnect all power supply circuits of the communication system before opening the housing:

- Disconnect the battery voltage, supply voltage and line voltage at any connected OpenScape Business Powerbox.
  - Disconnect the line cords of any connected battery pack or any connected batteries.
  - Disconnect the power plug of the communication system.
- 

***Step by Step***

- 1) Disconnect all power supply circuits of the communication system.
- 2) Make sure that the communication system is de-energized.
- 3) Loosen the two fixing screws on the housing cover with a slotted screw driver. Hold the housing cover so that it does not fall.



- 4) Remove the housing cover.





---

**CAUTION**

**Cuts caused by sharp edges on the shielding plate**

Make sure that you only touch the outside of the housing cover. The shielding plate on the inside of the housing cover may have sharp edges which can cause cuts.

---



- 5) Remove the stabilizer cap.
- 6) Pull out the OCCM mainboard from the board shelf and place it on a flat, grounded conductive surface.
- 7) Insert the EXMR subboard into the X16 and X17 socket terminal strips of the OCCM mainboard.
- 8) Slide the OCCM mainboard back into the slot that is provided on the board frame for this purpose.
- 9) Mount the stabilizer cap.
- 10) Close the housing. To do this, put the housing cover on and secure it with the two fixing screws. Make sure that you only touch the outside of the housing

## Boards

### Description of the Boards

cover. The shielding plate on the inside of the housing cover may have sharp edges which can cause cuts.

- 11) Place the communication system back into operation.

### 3.2.8.3 How to Install EXMR on OCCMR



---

#### **DANGER**

##### **Risk of electric shock through contact with live wires**

Disconnect all power supply circuits of the communication system before removing the OCCMR mainboard:

- Disconnect the battery voltage, supply voltage and line voltage at any connected OpenScape Business Powerbox.
  - Disconnect the line cords of any connected battery pack or any connected batteries.
  - Disconnect the power plug of the communication system.
- 

#### ***Step by Step***

- 1) Disconnect all power supply circuits of the communication system.
- 2) Make sure that the communication system is de-energized.
- 3) Loosen the two locking screws in the front panel of the OCCMR mainboard.
- 4) Loosen the OCCMR mainboard from the backplane using two board wrenches (C39165-A7027-C26).
- 5) Gently pull out the OCCMR mainboard with both hands horizontally from the board shelf and place it on a flat, grounded conductive surface.
- 6) Insert the EXMR subboard into the X23 and X24 socket terminal strips of the OCCMR mainboard.
- 7) Carefully slide the OCCMR mainboard with both hands horizontally back into the slot that is provided on the board frame for this purpose.
- 8) Attach the OCCMR mainboard to the shelf using the two locking screws.
- 9) Place the communication system back into operation.

### 3.2.9 IVMNL

The IVMNL (Integrated Voicemail New Large) board enables the voicemail functionality of Xpressions Compact in OpenScape Business X8. In addition, the board can be used for MOH (Music On Hold) and announcements.

Up to 500 mailboxes are available with a total storage capacity of 100 hours.

- IVMNL = 24 ports

For more detailed information, refer to the Xpressions Compact Administrator Documentation.

**Board Variants and their Use**

Board	Part Number	Used in		Maximum number
		Communication system	Country	
IVMNL	S30122-H7688-X	OpenScape Business X8	ROW	1

---

**NOTICE:** Damage from Overheating

For thermal reasons the IVMNL board may only be installed in the base box when OpenScape Business X8 is installed in a 19-inch rack.

---

In order to avoid inactive ports due to slow board boot-up, the following recommendations must be observed:

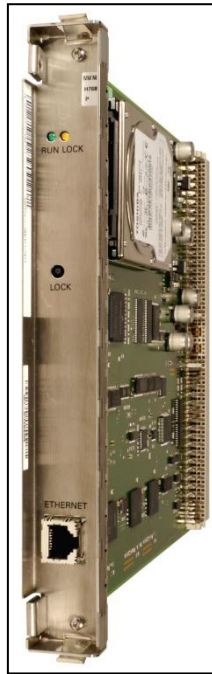
- Standalone installation:  
In a one-box system, the IVMNL board should be installed in the last slot of the base box. In a two-box system, the IVMNL board should be installed in the last slot of the expansion box. If possible, the two preceding slots should be kept free.
- 19" rack-mount installation:  
The IVMNL board should be installed in the last slot in the base box. If possible, the two preceding slots should be kept free.

## Boards

### Description of the Boards

#### Figure

Figure: IVMNL



#### Lockout switch

The front panel of the board has a lockout switch with the following functions:

- Lockout switch pressed = board is in normal operation (factory default)
- Lockout switch not pressed = board locked: existing connections remain active, new connections are locked.
  - The yellow LED lights up when all connections are ended and the board is effectively locked.
  - The yellow LED flashing when a lockout request is entered (via lockout switch or software) but at least one call is still active.

To reset a board to the default state, press the lockout switch four times (off-on-off-on) during the LED test at startup. This action cancels the LED test and both LEDs flash for approximately five seconds in confirmation.

#### LEDs

The board features a front panel with two LEDs that indicate the operating states.

**Table:** IVMNL – LED Statuses and their Meanings

Green LED	LED, yellow	Meaning	Action
<b>During Startup and Initialization</b>			
off	off	Phase 1: The operating system is being booted (approx. 30 s)	
off	flashing (500/500 ms)	Phase 2: Basic applications are being started (approx. 60 seconds)	
flashing (100/100 ms)	flashing (500/500 ms)	Phase 2: A lengthy process has been started (e.g., a hard disk check) (approx. 0 to 15 minutes)  Info: This process does not always occur.	
on	on	Phase 3: LED test (lasts approx. 10 s)	
off	flashing (500/500 ms)	Phase 4: Application are being started (approx. 2 to 9 minutes)	
on	off	Phase 5: Idle state (after successful startup)	
off	on	Phase 5: Board locked or board error occurred	Check whether the board was deactivated using Manager E or the lockout switch. Change board if faulty.
<b>During Operation</b>			
on	off	Idle state (no call)	
flashing (500/500 ms)	off	At least one active port (one active call)	
flashing (500/500 ms)	flashing (500/500 ms)	Lockout switch was activated during a call.	
off	on	Board locked or board error occurred	Check whether the board was deactivated using Manager E or the lockout switch. Change board if faulty.
flashing (100/100 ms)	flashing (500/500 ms)	During a hard disk check	
<b>During an upgrade</b>			
on	off	Idle state (no call)	

## Boards

### Description of the Boards

Green LED	LED, yellow	Meaning	Action
off	off	Restart before applying the special upgrade package	
on	on	LED test	
off	flashing (500/500 ms)	The upgrade package is applied to the board	
off	off	The board is rebooted	
off	flashing (100/100 ms)	The board is reconfigured	
off	off	The board is rebooted For subsequent steps, see "During Startup and Initialization"	

### Pin Assignments

The front panel of the board has an Ethernet (10/100BaseT) port (8-pin; RJ45 socket) for the administration (upgrade or backup and restore) of Xpressions Compact.

**Table:** IVMNL – Pin Assignments of the RJ45 Jack

Pin	Signal	Description
1	Tx +	Transmit +
2	Tx –	Transmit –
3	Rx +	Receive +
4	–	Not used
5	–	Not used
6	Rx –	Receive –
7	–	Not used
8	–	Not used

## 3.2.10 IVMP4, IVMP4R

The IVMP4 and IVMP4R (Integrated Voicemail Point Rack) boards provide Xpressions Compact voicemail functionality in OpenScape Business X3R, OpenScape Business X3W, OpenScape Business X5R and OpenScape Business X5W. The boards can also be used for Music on Hold and announcements.

Up to 30 mailboxes are available with a total storage capacity of 4 hours.

- IVMP4 = 4 ports

- IVMP4R = 4 ports

For more detailed information, refer to the Xpressions Compact Administrator Documentation.

**Board Variants and their Use**

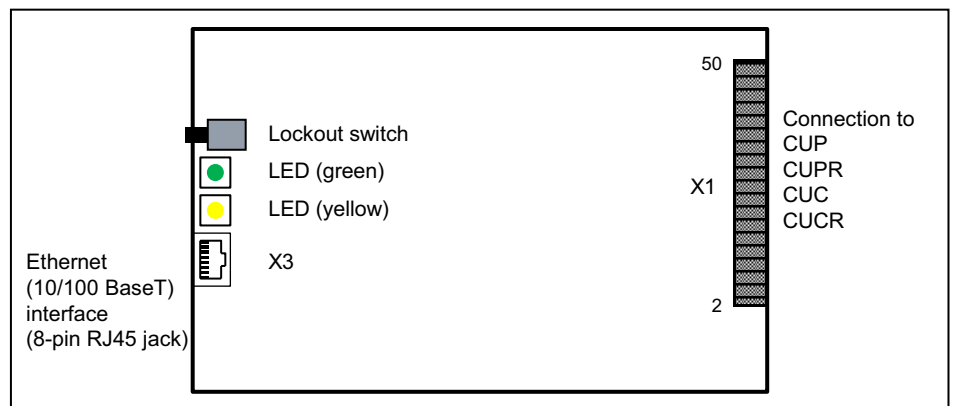
Board	Part Number	Used in		Maximum number
		Communication system	Country	
IVMP4	S30122-Q7721-X	OpenScape Business X3W OpenScape Business X5W	ROW	1
IVMP4R	S30122-K7721-X	OpenScape Business X3R OpenScape Business X5R	ROW	1

**NOTICE:** Damage from Overheating

For thermal reasons, the IVMP4 board may only be used in slot 5 of OpenScape Business X3W and in slots 5, 7 and 9 of OpenScape Business X5W.

**Figure**

**Figure:** IVMP4, IVMP4R



**Lockout switch**

The boards includes a lockout switch with the following functions:

- Lockout switch pressed = board is in normal operation (factory default)
- Lockout switch not pressed = board locked: existing connections remain active, new connections are locked.

## Boards

### Description of the Boards

- The yellow LED lights up when all connections are ended and the board is effectively locked.
- The yellow LED flashing when a lockout request is entered (via lockout switch or software) but at least one call is still active.

To reset a board to the default state, press the lockout switch four times (off-on-off-on) during the LED test at startup. This action cancels the LED test and both LEDs flash for approximately five seconds in confirmation.

### LEDs

The boards two LEDs that indicate the operating states.

**Table:** IVMP4, IVMP4R – LED Statuses and their Meanings

Green LED	LED, yellow	Meaning	Action
<b>During Startup and Initialization</b>			
off	off	Phase 1: The operating system is being booted (approx. 30 s)	
off	flashing (500/500 ms)	Phase 2: Basic applications are being started (approx. 60 seconds)	
flashing (100/100 ms)	flashing (500/500 ms)	Phase 2: A lengthy process has been started (e.g., a hard disk check) (approx. 0 to 15 minutes)  Info: This process does not always occur.	
on	on	Phase 3: LED test (lasts approx. 10 s)	
off	flashing (500/500 ms)	Phase 4: Application are being started (approx. 2 to 9 minutes)	
on	off	Phase 5: Idle state (after successful startup)	
off	on	Phase 5: Board locked or board error occurred	Check whether the board was deactivated using Manager E or the lockout switch. Change board if faulty.
<b>During Operation</b>			
on	off	Idle state (no call)	
flashing (500/500 ms)	off	At least one active port (one active call)	
flashing (500/500 ms)	flashing (500/500 ms)	Lockout switch was activated during a call.	



Green LED	LED, yellow	Meaning	Action
off	on	Board locked or board error occurred	Check whether the board was deactivated using Manager E or the lockout switch. Change board if faulty.
flashing (100/100 ms)	flashing (500/500 ms)	During a hard disk check	
<b>During an upgrade</b>			
on	off	Idle state (no call)	
off	off	Restart before applying the special upgrade package	
on	on	LED test	
off	flashing (500/500 ms)	The upgrade package is applied to the board	
off	off	The board is rebooted	
off	flashing (100/100 ms)	The board is reconfigured	
off	off	The board is rebooted For subsequent steps, see "During Startup and Initialization"	

### Pin Assignments

The boards feature an Ethernet (10/100BaseT) interface (8-pin RJ45 jack) that is used for administering Xpressions Compact (i.e., for performing functions such as upgrade, backup and restore).

**Table:** IVMP4, IVMP4R – Pin Assignments of the RJ45 Jack

Pin	Signal	Description
1	Tx +	Transmit +
2	Tx –	Transmit –
3	Rx +	Receive +
4	–	Not used
5	–	Not used
6	Rx –	Receive –
7	–	Not used
8	–	Not used

## Boards

Description of the Boards

### 3.2.11 IVMS8N, IVMS8NR

The IVMS8N and IVMS8NR (Integrated Voicemail Small New, Rack) boards provide Xpressions Compact voicemail functionality in OpenScape Business X3R, OpenScape Business X3W, OpenScape Business X5R and OpenScape Business X5W. The boards can also be used for Music on Hold and announcements.

Up to 500 mailboxes are available with a total storage capacity of 100 hours.

- IVMS8N = 8 ports
- IVMS8NR = 8 ports

For more detailed information, refer to the Xpressions Compact Administrator Documentation.

#### Board Variants and their Use

Board	Part Number	Used in		Maximum number
		Communication system	Country	
IVMS8N	S30122-Q7379-X200	OpenScape Business X3W OpenScape Business X5W	ROW	1
IVMS8NR	S30122-K7379-Z200	OpenScape Business X3R OpenScape Business X5R	ROW	1

---

**NOTICE:** Damage from Overheating

For thermal reasons, the IVMS8N board may only be used in slot 5 of OpenScape Business X3W and in slots 5, 7 and 9 of OpenScape Business X5W.

---



## Boards

### Description of the Boards

Green LED	LED, yellow	Meaning	Action
flashing (100/100 ms)	flashing (500/500 ms)	Phase 2: A lengthy process has been started (e.g., a hard disk check) (approx. 0 to 15 minutes)  Info: This process does not always occur.	
on	on	Phase 3: LED test (lasts approx. 10 s)	
off	flashing (500/500 ms)	Phase 4: Application are being started (approx. 2 to 9 minutes)	
on	off	Phase 5: Idle state (after successful startup)	
off	on	Phase 5: Board locked or board error occurred	Check whether the board was deactivated using Manager E or the lockout switch. Change board if faulty.
<b>During Operation</b>			
on	off	Idle state (no call)	
flashing (500/500 ms)	off	At least one active port (one active call)	
flashing (500/500 ms)	flashing (500/500 ms)	Lockout switch was activated during a call.	
off	on	Board locked or board error occurred	Check whether the board was deactivated using Manager E or the lockout switch. Change board if faulty.
flashing (100/100 ms)	flashing (500/500 ms)	During a hard disk check	
<b>During an upgrade</b>			
on	off	Idle state (no call)	
off	off	Restart before applying the special upgrade package	
on	on	LED test	
off	flashing (500/500 ms)	The upgrade package is applied to the board	

Green LED	LED, yellow	Meaning	Action
off	off	The board is rebooted	
off	flashing (100/100 ms)	The board is reconfigured	
off	off	The board is rebooted For subsequent steps, see "During Startup and Initialization"	

### Pin Assignments

The boards feature an Ethernet (10/100BaseT) interface (8-pin RJ45 jack) that is used for administering Xpressions Compact (i.e., for performing functions such as upgrade, backup and restore).

**Table:** IVMS8N, IVMS8NR – Pin Assignments of the RJ45 Jack

Pin	Signal	Description
1	Tx +	Transmit +
2	Tx –	Transmit –
3	Rx +	Receive +
4	–	Not used
5	–	Not used
6	Rx –	Receive –
7	–	Not used
8	–	Not used

## 3.2.12 LUNA2

LUNA2 (Line-powered Unit For Network-based Architecture No. 2) is the central power supply of the OpenScape Business X8 communication system. Depending on the configuration, LUNA2 can be used up to three times in the base box and up to four times in the expansion box.

The required number of LUNA2 modules depends on the number and the type of the boards used. For information on how to calculate the number of modules required, see [Table: Calculating the number of LUNA2 modules required](#).

If the OpenScape Business X8 communication system has been configured as a two-box system, two LUNA2 in the basic box and three LUNA2 in the expansion box are sufficient to ensure the maximum capacity limits (see OpenScape Business, Administrator Documentation, Configuration Limits and Capacities: System-specific Capacity Limits).

## Boards

### Description of the Boards

You can use a third LUNA2 in the base box and a fourth in the expansion box to ensure error-free operation if one LUNA2 module fails (redundant LUNA2) or to charge the batteries of a connected battery box (48V/38Ah) or OpenScape Business Powerbox.

LUNA2 supports power supply and battery management functions. No other components are required if it is operated as a power supply. To maintain short-term battery emergency operation after a power failure, that is, to use uninterruptible power supply functions, you must connect an additional 48V/38Ah battery pack or an OpenScape Business Powerbox for each system box. The following options are available:

- Use of a 48-V/38-Ah battery box with four 12-V/38-Ah batteries  
The batteries are charged via the redundant LUNA2 in the respective system box.
- Use of an OpenScape Business Powerbox with four 12V/7Ah batteries (48V/7Ah battery pack)  
The batteries are charged via the redundant LUNA2 in the respective system box.  
Only the 48V/7Ah battery pack (with four 12V/7Ah batteries, V39113-W5123-E891) is released for use in the OpenScape Business Powerbox.
- Use of the OpenScape Business Powerbox with four 12V/7Ah batteries (48V/7Ah battery pack) and one LUNA2 power supply  
The batteries are charged via the LUNA2 in the OpenScape Business Powerbox.  
Only the 48V/7Ah battery pack (with four 12V/7Ah batteries, V39113-W5123-E891) is released for use in the OpenScape Business Powerbox.

### Board Variants and their Use

Board	Part Number	Used in		Maximum number
		Communication system	Country	
LUNA2	S30122-H7686-X1	OpenScape Business X8	ROW	7

### Technical Data

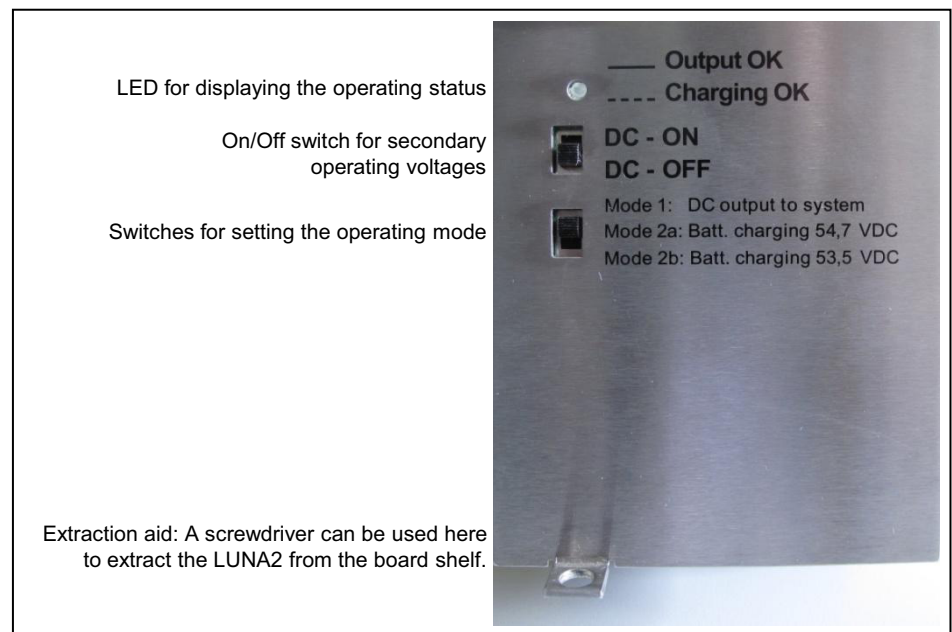
- Nominal voltage range: 110 VAC - 240 VAC
- Nominal frequency: 50 Hz - 60 Hz
- Battery charging voltage, if LUNA2 is used as a battery charger:
  - -54.7 VDC
  - -53.5 VDC (for gel cell batteries)  
Gel cell batteries are not approved for use!
- Battery charge current, if LUNA2 is used as a battery charger: max. 2 amps
- Bridging times (for emergency battery operation in the event of power failure):  
The maximum bridging times given in the following table are basic orientation values. The actual values may vary depending on the system configuration.

**Table:** LUNA2 – Bridging Times

Conditions	Load levels	Maximum bridging time
OpenScape Business X8 with two LUNA2 per system box for the power supply  OpenScape Business Powerbox equipped with one LUNA2 as a battery charger and four 12V/7Ah batteries	60 % nominal load	Approx. 25 minutes
Measurement conditions:  All measurements were performed at a room temperature of approximately 22 °C (71.6 °F).  The batteries were new and fully charged when measurement started.		

**Figure**

**Figure:** LUNA2 – Front Panel



**LED**

The board features a front panel LED for indicating the operating state.

**Table:** LUNA2 – LED Statuses and their Meanings

LED	Meaning		Action
on	LUNA2 is operating as power supply unit		
flashing	LUNA2 is operating as a battery charger		
off	At least one secondary operating voltage is outside the tolerance range.	The feeding power of LUNA2 is not sufficient.	An additional LUNA2 module is required.  See <a href="#">Table: Calculating the number of LUNA2 modules required</a>
		LUNA2 is defective.	LUNA2 must be replaced.

**Switches**

The front panel includes two slide switches with the following functions.

**Table:** LUNA2 – Switches and their Functions

Switches	Switch position	Meaning
ON/OFF switch for secondary operating voltages (system supply voltages)	DC-ON	The communications system is supplied with power.
	DC-OFF	LUNA-2
Switches for setting the operating mode	Mode 1	LUNA2 is operating as power supply unit (LED on).
	Mode 2a	LUNA2 is operating as a battery charger (LED flashing) with a charging voltage of 54.7 Vdc.
	Mode 2b	LUNA2 is operating as a battery charger (LED flashing) with a charging voltage of 53.5 VDC.



**WARNING**

**Risk of electric shock through contact with live wires**

Set the switches of all LUNA2 modules to DC-OFF during maintenance work that requires the communication system to be de-energized (for example, central board replacement).

Disconnect all the communication system's power plugs and make sure that the communication system is not supplied by another power source (uninterrupted power supply unit, for instance).

The communication system is only restarted if all LUNA2 switches are returned to the "DC-ON" position.



## Slots

The slots for the LUNA2 are located in the lower part of the shelf of a system box. The base box has three slots and the expansion box has four slots.

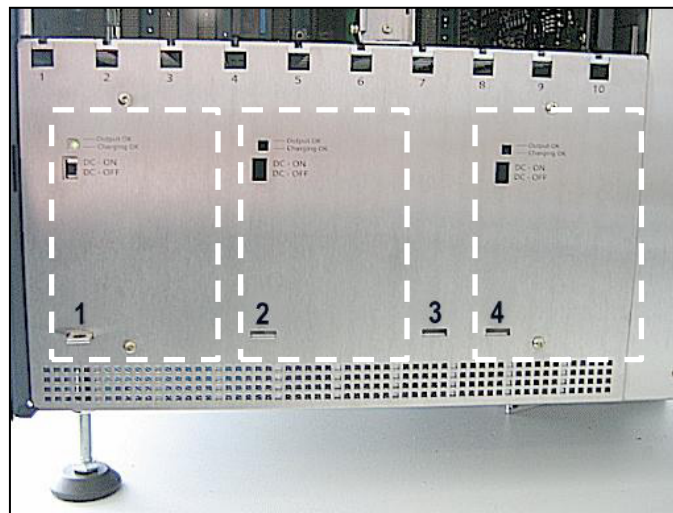
---

**INFO:** LUNA2 can only be plugged in or out when the system is switched off (switch position = DC-OFF).

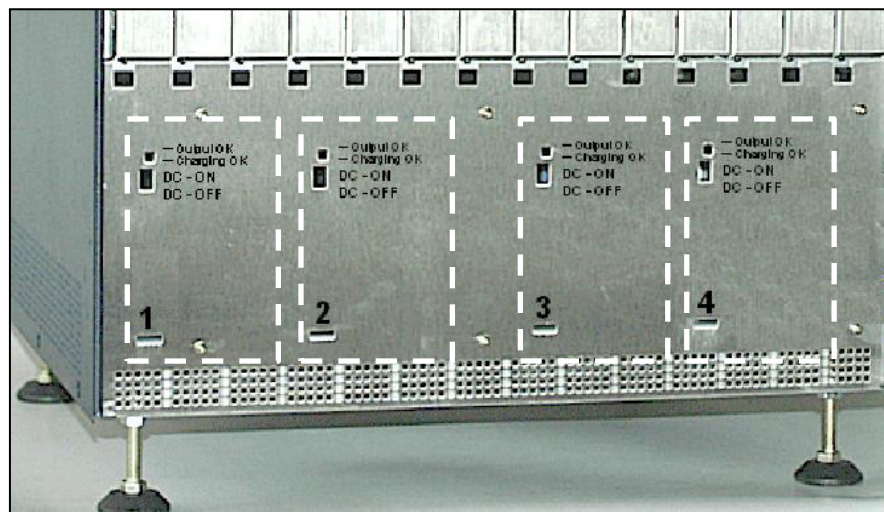
---

The slots of the power supply units must be covered with the outer panel shown in the figures below before the communication system is started up.

**Figure:** LUNA2 – Slots 1, 2 and 4 in the Base box



**Figure:** LUNA2 – Slots 1, 2 and 4 in the Expansion Box



From a technical viewpoint, there are no differences between the slots. The LUNA2 modules can be used in all slots, regardless of the selected operating mode. However, to ensure optimal ventilation, there should be at least one free slot between two LUNA2 modules if possible. To achieve a uniform LUNA2

## Boards

### Description of the Boards

configuration of the communication systems worldwide, the following rules should be observed:

- Slots 1 and 4 of the base box and slots 1, 3 and 4 of the expansion box should be used for the LUNA2 modules which power the communication system.
- Slot 2 should be used for the LUNA2 modules that
  - are used for LUNA2 redundancy or
  - as battery chargers.

### Calculating the Number of LUNA2 Modules Required

---

**INFO:** The use of at least two LUNA2 modules per system box is recommended.

---

The number of LUNA2 required for OpenScope Business X8 modules in relation to the number and type of boards installed can be calculated using the following table.

**Table:** Calculating the number of LUNA2 modules required

System Box	Number of peripheral boards per system box	SLMA and/or SLCN board available	Number of LUNA2 modules required per system box
Base box	Less than 5	no	1
	Less than 5	yes	2
	5 or more	no	2
	5 or more	yes	2
Expansion box	Less than 5	no	1
	Less than 5	yes	2
	5 or more	no	2
	5 or more	yes	3
	10 or more	no	3
	10 or more	yes	3

Examples of a one-box system:

- Base box with OCCL and peripheral boards (without SLMA or SLCN board)
  - A single LUNA2 can feed one OCCL and up to four peripheral boards.
  - A second LUNA2 is required for five or more peripheral boards.
  - A third LUNA2 can be used as a battery charger or as a redundant LUNA2.
- Base box with OCCL and peripheral boards (SLMA or/and SLCN board present)
  - Two LUNA2s are required to feed the OCCL, the peripheral boards and the SLMA and/or SLCN.
  - A third LUNA2 can be used as a battery charger or as a redundant LUNA2.

### 3.2.13 MMP3R

The MMP3R (Sound Player Music Module MP3 Rack) music module is an external MP3 player for music on hold (MOH). The connection to the communication system is established via an EXMR subboard.

The module has a slot for an SD card on which the MP3 music files can be stored. The delivery package includes a CD with sample music.

The MMP3R music module supports the A-law codec for digitizing analog audio signals.

---

**INFO:** Before loading music files, make sure that you do not infringe on any copyrights.

---

#### Board Variants and their Use

Board	Part Number	Used in		Maximum number
		Communication system	Country	
MMP3R A-law version	S30122-K7731-Z	OpenScape Business X3R  OpenScape Business X5R	ROW	1

The connection to the EXMR subboard is established via the RCA jack in the front panel of the communication system.

### 3.2.14 MUSIC plugin module

The MUSIC plugin module is an option for OpenScape Business X3/X5/X8 and provides Music on Hold (MoH).

---

**INFO:** Before loading music files, make sure that you do not infringe on any copyrights.

---

**Board Variants and their Use**

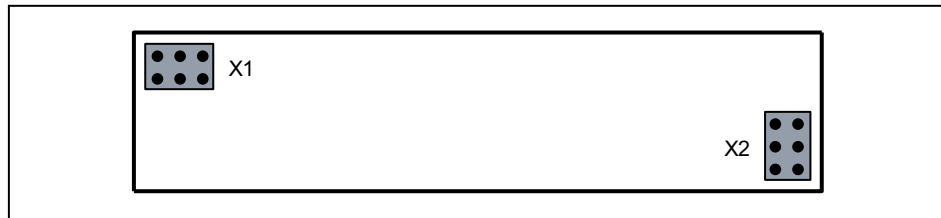
Board	Part Number	Used in		Maximum number
		Communication system	Country	
MUSIC plugin module	S30122- -T	OpenScape Business X3R OpenScape Business X3W OpenScape Business X5R OpenScape Business X5W OpenScape Business X8	ROW	1

The MUSIC plugin module is plugged into the following socket terminal strips on the mainboards:

- OCCL: socket terminal strips X9 and X10
- OCCM: socket terminal strips X16 and X17
- OCCMR: socket terminal strips X23 and X24

**Figure**

**Figure:** MUSIC plugin module




---

**NOTICE:** Place the mainboard on a flat surface before inserting the MUSIC plug-in board. Otherwise you may damage the mainboard.

---

**3.2.15 MPPI USB EXM**

The MPPI-USB EXM module is an option for OpenScape Business X3/X5 and is used as a source for Music on Hold and announcements.

---

**INFO:** MPPI is a registered trademark of BEYERTONE GmbH.

---

The module can be switched between A-law and  $\mu$ -law with the aid of a small jumper.

The import of music on hold and announcements occurs via the supplied USB flash drive (incl. a USB cable) or alternatively via an audio input for connecting external devices. A number of different royalty-free music titles are included free of charge on the USB flash drive. Using the PC software supplied on the flash drive, customers can also create their own customized recordings for the MPPI USB EXM module.

---

**INFO:** Before loading music files, make sure that you do not infringe on any copyrights.

---

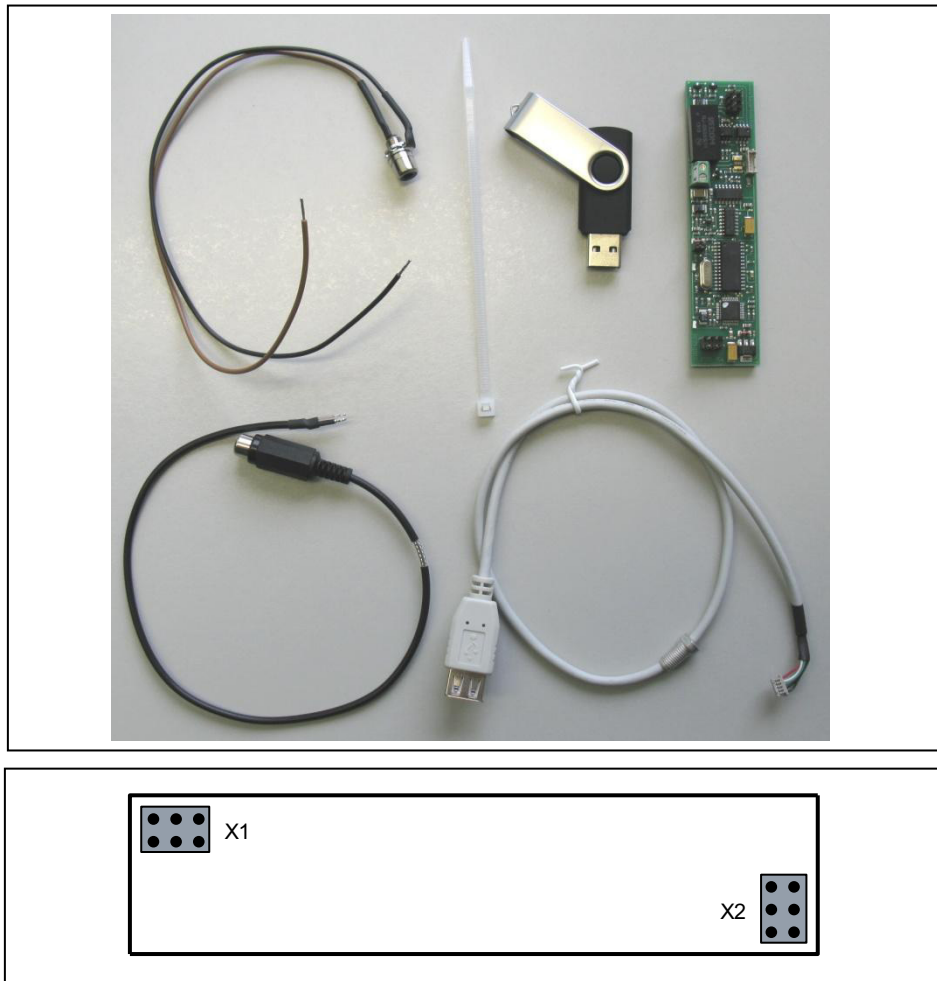
### Board Variants and their Use

Board	Part Number	Used in		Maximum number
		Communication system	Country	
MPPI USB EXM		OpenScape Business X3R OpenScape Business X3W OpenScape Business X5R OpenScape Business X5W	ROW	1

The MPPI-USB EXM module is plugged into the following socket terminal strips on the mainboards:

- OCCM: socket terminal strips X16 and X17
- OCCMR: socket terminal strips X23 and X24

**Figure**  
**Figure:** MPPI USB EXM module



---

**NOTICE:** Place the mainboard on a flat surface before inserting the MPPI-USB EXM module. Otherwise you may damage the mainboard.

---

### 3.2.16 OCAB (UC Booster Card)

The UC Booster Card (OCAB, Open Application Core Booster, Application Board) provides advanced UC functionality for the communication system.

The UC Booster Card expands the OpenScape Business X3/X5/X8 communication systems with the following functions:

- UC Suite for unified communications and collaboration for up to 150 users
- OpenStage Gate View with up to two cameras

- Open Directory Service
- CSTA interface for connecting external applications
- OpenScape Business TAPI 120/170

If there are more than 150 UC Suite users and if more than two cameras are required for OpenStage Gate View, then the OpenScape Business UC Booster Server (Application Server) should be used instead of the UC Booster Card.

The UC Booster Card is mounted within the communication system. The hard drive located on the board contains the preinstalled software for the advanced UC functionality, including the documentation in the form of PDF files. The hard disk also serves as a storage medium for the customer and diagnostic data generated by UC Suite.

---

**INFO:** The use of the features mentioned above requires a license.

Refer to the topic *Licensing* in the *OpenScape Business Administrator Documentation* for detailed information.

---

The UC Booster Card can be optionally put into operation even without the UC solution UC Suite. The features of the UC solution UC Smart can be used instead.

Administrative access to all functions of the UC Booster Card occurs via the WBM. These functions include the backup and recovery of data, software updates and remote services, for example.

### **Temperature Monitoring**

The temperature of the UC Booster Card hard disk is monitored. At temperatures higher than 56 degrees Celsius, a notification can be sent to up to three system telephones with a display, by e-mail or through signaling via an SNMP trap. Entries are made in the event log and event viewer (client trace) only if the system exceeds or falls below the critical temperatures. Logging occurs in the message log until the value is less than or equal to 54° Celsius.

At temperatures above 61 °C, the message "Alarm: critical system temperature!" is displayed on the home page of the OpenScape Business Assistant (WBM). The UC Booster Card shuts down automatically. Then, the system must be shut down and disconnected from the power supply. After checking the UC Booster Card, the system can be reconnected to the power supply and restarted. The alarm is thus cleared, and the UC Booster Card is put back into operation.

### **Power consumption**

The power requirements of the system must be determined when using the UC Booster Card (see the *Appendix 'Power Requirements of a Communication System'*). If the power requirements exceed 48 Watts at -48V, an additional power supply (OpenScape Business PowerBox) is required.





- X2 = LAN port 2 (preferred LAN port)

For linking into the LAN infrastructure of the customer, for connecting a WLAN Access Point, an additional LAN switch or the direct connection of an IP phone or PC client.

Two LEDs indicate the current status of each LAN interface. Special OCAB states (FW update, Linux recovery) are also signaled via these two LEDs.

**Table:** OCAB – LAN-LEDs: Indicate interface status

Left LED (Speed)	Right LED (Link/Activity)	Meaning
off	–	10 Mbps connection
steady green light	–	100 Mbps connection
steady yellow light	–	1,000-Mbps connection
–	flashing green	Activity
off	off	No connection/activity

**Table:** OCAB – LAN-LEDs: Indicate special OCAB states

X1 LAN LEDs		X2 LAN-LEDs		Meaning
left	right	left	right	
flashing green 1 Hz	flashing green 1 Hz	flashing green 1 Hz	flashing green 1 Hz	Prerequisite: An OCAB firmware update is available.  The OCAB FW update is started. During the firmware update, the system must not be disconnected from the power supply! After the software update has been completed successfully, a restart is automatically performed.
flickering 100 ms	flickering 100 ms	flickering 100 ms	flickering 100 ms	Scan time for the query whether a condition for an OCAB Linux recovery is present (admin port X1 and active and LAN port X2 inactive). If no condition for the recovery is detected within 3 seconds, the LEDs switch back to the normal operating mode.
Standard Ethernet mode	Standard Ethernet mode	flashing green 1 Hz	flashing yellow 1 Hz	Prerequisite: The condition for an OCAB Linux recovery was detected.  The files needed for an OCAB restart using TFTP are download (via the admin port X1). Once the Linux recovery is complete, the LEDs switch back to the normal operating mode.

- X4 = Plug contact for the connection cable to the mainboard

### LEDs

The colors, arrangement and meaning of the LEDs on the UC Booster Card (OCAB) depend on the OCAB hardware version.

## Boards

### Description of the Boards

Until OCAB version **S30807-K6950-X-G1**, the following applies: There are two controller LEDs (green and yellow) on the UC Booster Card, which provide information on the SATA connection and the hard drive activity.

**Table:** OCAB (until S30807-K6950-X-G1) – Controller LED Statuses and their Meanings

LED		Meaning
green	yellow	
off	off	Default state after the communication system is connected to the power supply (< 1 s)
off	off	The SATA connection is not yet established or the hard drive is missing or not recognized.
on	off	The SATA connection is established; the hard drive is ready for operation.
on	off	No hard disk activity.
on	flashing	Hard disk activity.
off	off	After the OCAB has been shut down: The shutdown of the OCAB board has been completed.

As of OCAB version **S30807-K6950-X-8**, the following applies: There are two LEDs on the UC Booster Card OCAB (green and red), which reflect the operating states of the system and the OCAB.

**Table:** OCAB (as of S30807-K6950-X-8) – LED Statuses and their Meanings

LED		Meaning
green	red	
off	off	Default state after the communication system is connected to the power supply (< 1 s)
on	off	UBOOT (Universal Boot Loader) Startup. The LED states do not change until the UBOOT startup has been completed. Hard drive ready for use.
off	on	UBOOT startup cannot be completed: critical error (Linux startup not possible) or hard drive is not ready.
off	off	UBOOT startup completed. Linux startup begins. Linux switches off the LEDs shortly after initiating the startup.
on	off	Linux startup running.
on	on	System startup is running (after the Linux startup is completed).
flickering 3x100/500	on	First Application Daemon running (Status Server Daemon).

LED		Meaning
green	red	
flickering 3x100/500	off	UC SW Startup Procedure running (SQL access to OCC possible).
flashing	off	Normal operating state (1 Hz)  The flash rate depends on the system load. The slower the green LED flashes, the greater the system load.
off	off	The shutdown of the communication has been completed. The system can be disconnected from the mains.

Special OCAB states (FW update, Linux recovery) are displayed via the two Ethernet LEDs (see the table in **Connections** section above).

In addition, the LEDs on the OCCx mainboard also provide information about the accessibility of the OCAB over IP.

### Pin Assignments

**Table:** OCAB - Pin assignments of the X1 and X2 RJ45 connectors (Ethernet interfaces), depending on the connection

Pin	10/100BaseT		1000BaseT	
	Signal	Description	Signal	Description
1	Tx +	Transmit +	Tx A +	Pair A: Transmit +
2	Tx –	Transmit –	Tx A –	Pair A: Transmit -
3	Rx +	Receive +	Tx B +	Pair B: Transmit +
4	–	Not used	Tx C +	Pair C: Transmit +
5	–	Not used	Tx C –	Pair C: Transmit -
6	Rx –	Receive –	Tx B –	Pair B: Transmit -
7	–	Not used	Tx D +	Pair D: Transmit +
8	–	Not used	Tx D –	Pair D: Transmit -

### 3.2.16.1 How to Mount the OCAB and the Fan Kit in an X8 System

In addition, the , which includes **Required Packages**

UC Booster Card (S30807-K6950-X):

- 1 OCAB (UC Booster Card)
- 1 OCAB - OCCx connection cable
- 2
- 
- 4 Torx screws for the

C39117-A7003-B613:

## Boards

### Description of the Boards

- 2 fans
- 1 fan holder
- 1 fixing bracket
- 2 Torx screws for the fixing bracket
- 3 self-adhesive mounting bases
- 3 cable ties



#### **DANGER**

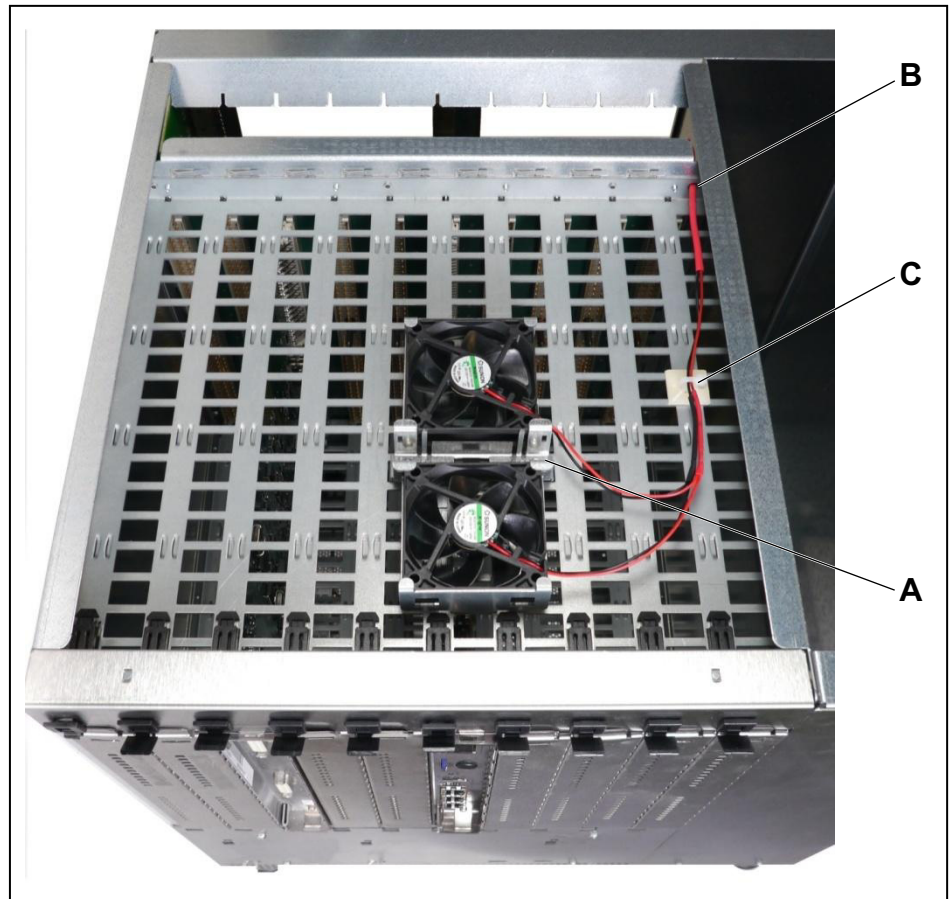
##### **Risk of electric shock through contact with live wires**

Disconnect all power supply circuits of the communication system before removing the OCCL mainboard:

- Disconnect the battery voltage, supply voltage and line voltage at any connected OpenScape Business Powerbox.
  - Disconnect the line cords of any connected battery pack or any connected batteries.
  - Disconnect all power plugs of the communication system.
- 

#### **Step by Step**

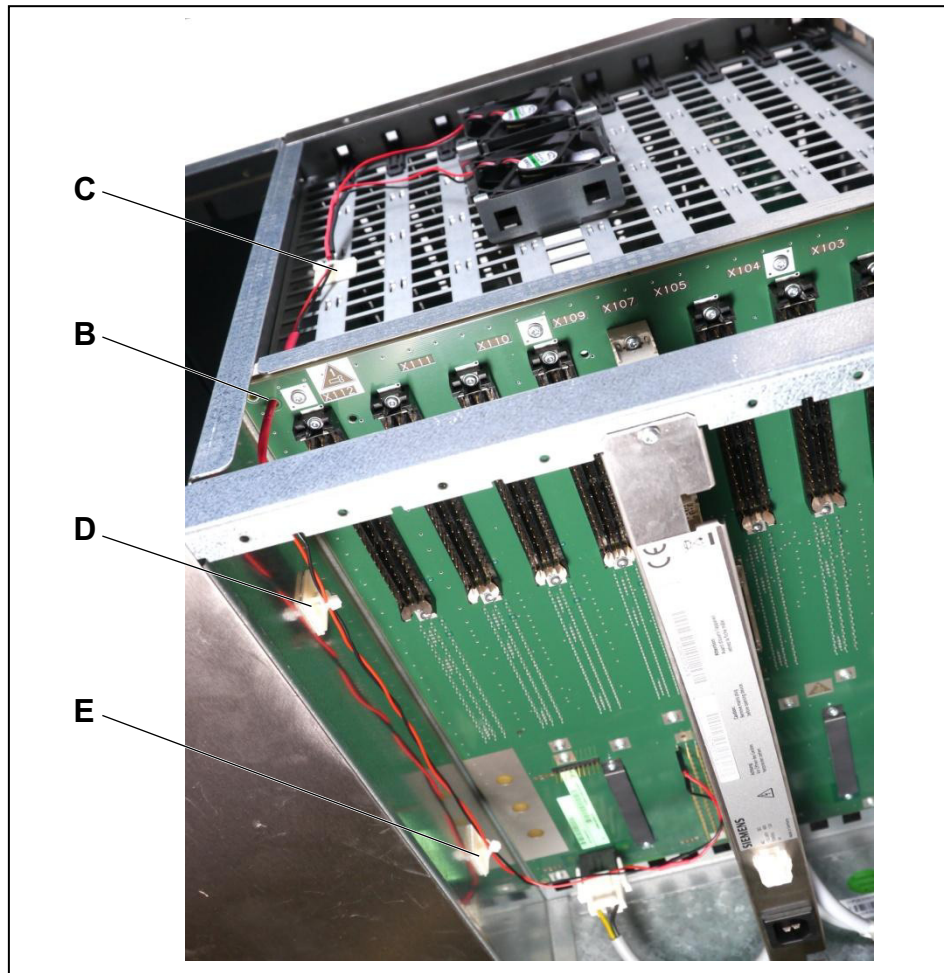
- 1)** Disconnect all power supply circuits of the communication system.
- 2)** Make sure that the communication system is de-energized.
- 3)** Remove the front plastic cover, if present.
- 4)** Mount the X8 fan kit:
  - a)** If the system is installed in a 19 "rack, remove the system from the 19" rack.
  - b)** Using a T20 Torx screwdriver, remove the screws and lift off the cover.
  - c)** Clamp the fan holder in the upper grid of the case (above the 6th board slot from the left). Make sure that the fan holder is centered flush on the black board latches.
  - d)** Put the two fans into the fan holder. Pay special attention to the correct air flow direction, which is indicated by arrows on the fan housing (the arrows point out of the system, i.e., the warm air must be drawn out of the system).



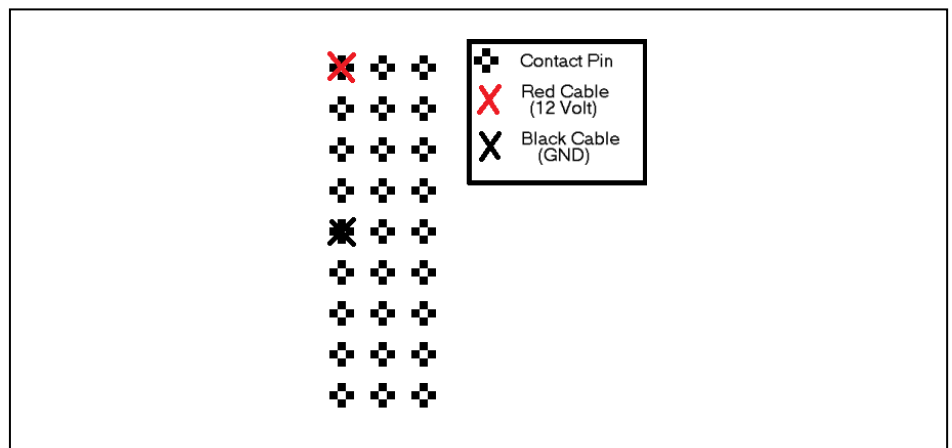
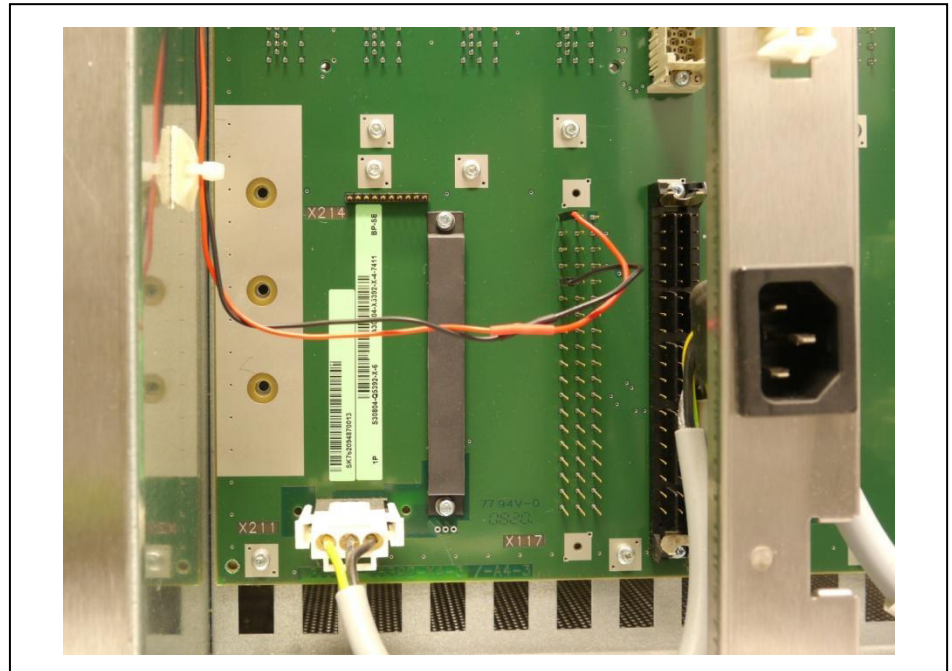
- e)** Place the fixing bracket (A) on the fan holder and screw the bracket onto the holder using the two Torx screws.
- f)** Insert the two power cable connectors in succession through the hole in the frame and the backplane (B).
- g)** Align the fan power cable so that the longer shrink tubing is centered in the transition zone to the backplane.
- h)** Stick one of the supplied mounting bases centered on the last row of the grid from the right and secure the fan power cable to it with one of the supplied cable ties (C).
- i)** Stick the two remaining mounting bases on the housing wall and secure the fan power cable to them with two other cable ties (D and E).

## Boards

### Description of the Boards



- j)* Connect the two power cable plugs to the X117 backplane connector. Note that the red plug must be connected to the first left pin from the top, and the black plug to the fifth left pin from the top. Make sure that sufficient distance from the internal 230V wiring is maintained.



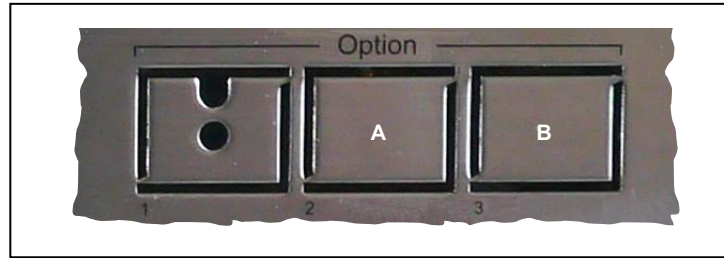
**5) Install the OCAB:**

- a)** Insert the tip of the board wrench marked “Pull” into the top opening in the front cover of the OCCL mainboard.
- b)** Lever the OCCL mainboard out of the board shelf of the base box by pushing the board wrench upwards.
- c)** Pull out the OCCL mainboard from the board shelf and place it on a flat, grounded conductive surface.
- d)** Carefully remove the protection shields marked in the figure with [A] and [B] from the front panel of the OCCL mainboard.



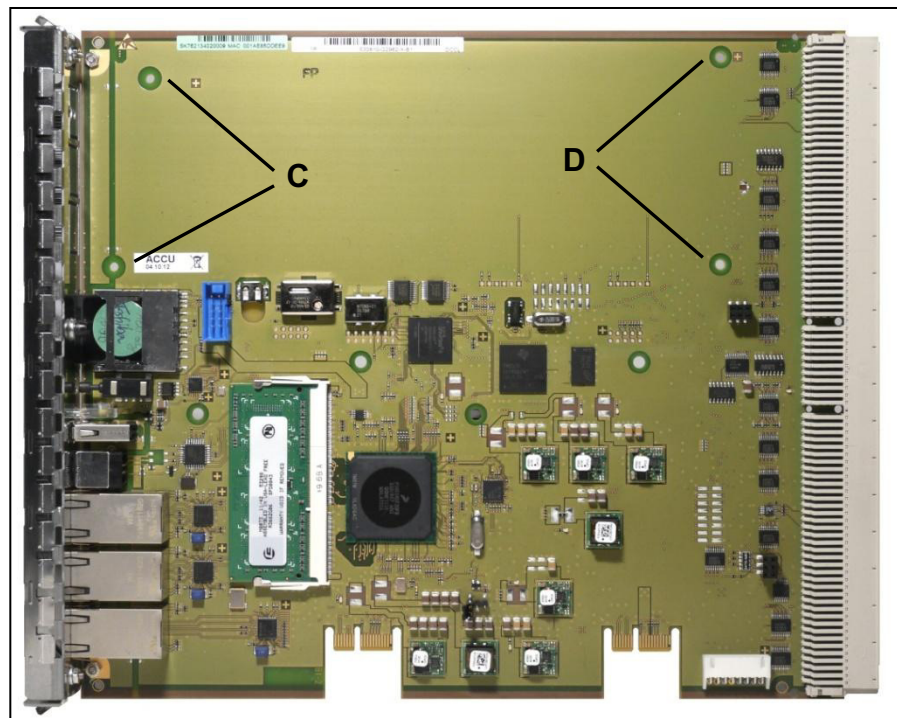
## Boards

### Description of the Boards



- e) Place the two screw spacers on top of the holes marked with [C] on the OCCL mainboard and screw in the spacers from the bottom using one Torx screw each.

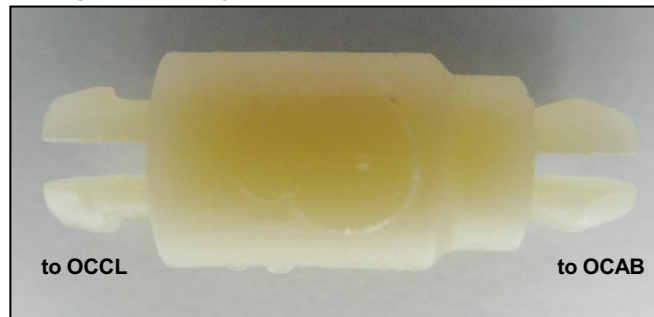
**Figure:** OCCL – Mounting Holes for the UC Booster Card OCAB



- f) Insert the two plug-in spacing bolts on the OCCL side into the holes marked with [D] on the OCCL mainboard. Make sure that the spacing bolts are snapped into place securely on the mainboard.

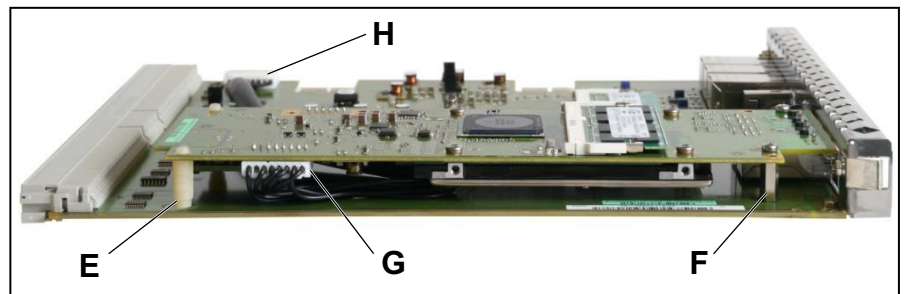


**Figure:** Spacing Bolts



- g)** Insert the connection cable supplied with the UC Booster Card OCAB into the X4 connector (G) of the UC Booster Card.

**Figure:** OCCL - Mounting the UC Booster Card OCAB

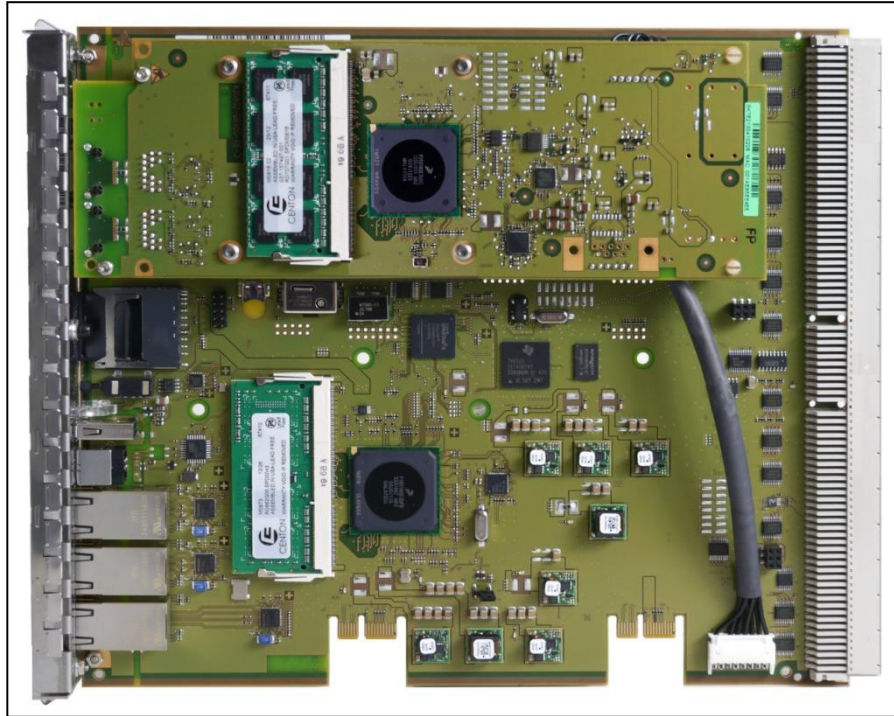


- h)** Mount the UC Booster Card OCAB on the OCCL mainboard. Make sure that the two spacing bolts [E] are placed in the holes provided for them on the UC Booster Card OCAB and that the two LEDs on the UC Booster Card protrude through the front panel of the mainboard.
- i)** Fix the UC Booster Card OCAB with one Torx screw each at the two spacers [F].
- j)** Insert the connecting cable into the X8 connector (H) of the OCCL mainboard.

## Boards

### Description of the Boards

**Figure:** UC Booster Card OCAB mounted on OCCL



- k)** Using its guide rails, slide the OCCL mainboard back into the appropriate slot on the base box shelf.

---

**NOTICE:** When inserting the OCCL mainboard into the board shelf, make sure that the connection cable is not damaged.

---

- l)** Insert the tip of the board wrench marked "Plug-In" into the bottom opening in the front cover of the OCCL mainboard.
- m)** Lever the mainboard into the board shelf of the base box by pushing the board wrench upwards.
- 6)** Screw on the housing cover again.
- 7)** If the system was installed in a 19" rack, put the system back into the 19" rack.
- 8)** Attach the front plastic cover, if present.
- 9)** Put the communication system into operation (see the section "Initial Installation of OpenScape Business X3/X5/X8" in the OpenScape Business Administrator Documentation).

### 3.2.16.2 How to Mount the OCAB and the Fan Kit in an X3W or X5W System

inserted with the component side up in option 2, 3 or 4 of slot level 3 and in option 3 or 4 (recommended) of slot level 5 for the X5W. In addition, the UC Booster Card needs a fan kit with the fans mounted on the inside of the X3W/X5W housing.

### Required Packages

UC Booster Card (S30807-K6950-X):

- 1 OCAB (UC Booster Card)
- 1 OCAB - OCCM connection cable

for C39165-A7021-B305:

- 1 new housing cover

C39165-A7021-B320:

- 1 fan kit
- 2 cable ties

C39165-A7021-B313:

- 2 spacers



### **DANGER**

#### **Risk of electric shock through contact with live wires**

Disconnect all power supply circuits of the communication system before opening the housing:

- Disconnect the battery voltage, supply voltage and line voltage at any connected OpenScape Business Powerbox.
  - Disconnect the line cords of any connected battery pack or any connected batteries.
  - Disconnect the power plug of the communication system.
- 

### ***Step by Step***

- 1) Disconnect all power supply circuits of the communication system.
- 2) Make sure that the communication system is de-energized.
- 3) Loosen the two fixing screws on the housing cover with a slotted screw driver. Hold the housing cover so that it does not fall.

## Boards

### Description of the Boards



4) Remove the housing cover.



---

#### CAUTION

##### **Cuts caused by sharp edges on the shielding plate**

Make sure that you only touch the outside of the housing cover. The shielding plate on the inside of the housing cover may have sharp edges which can cause cuts.

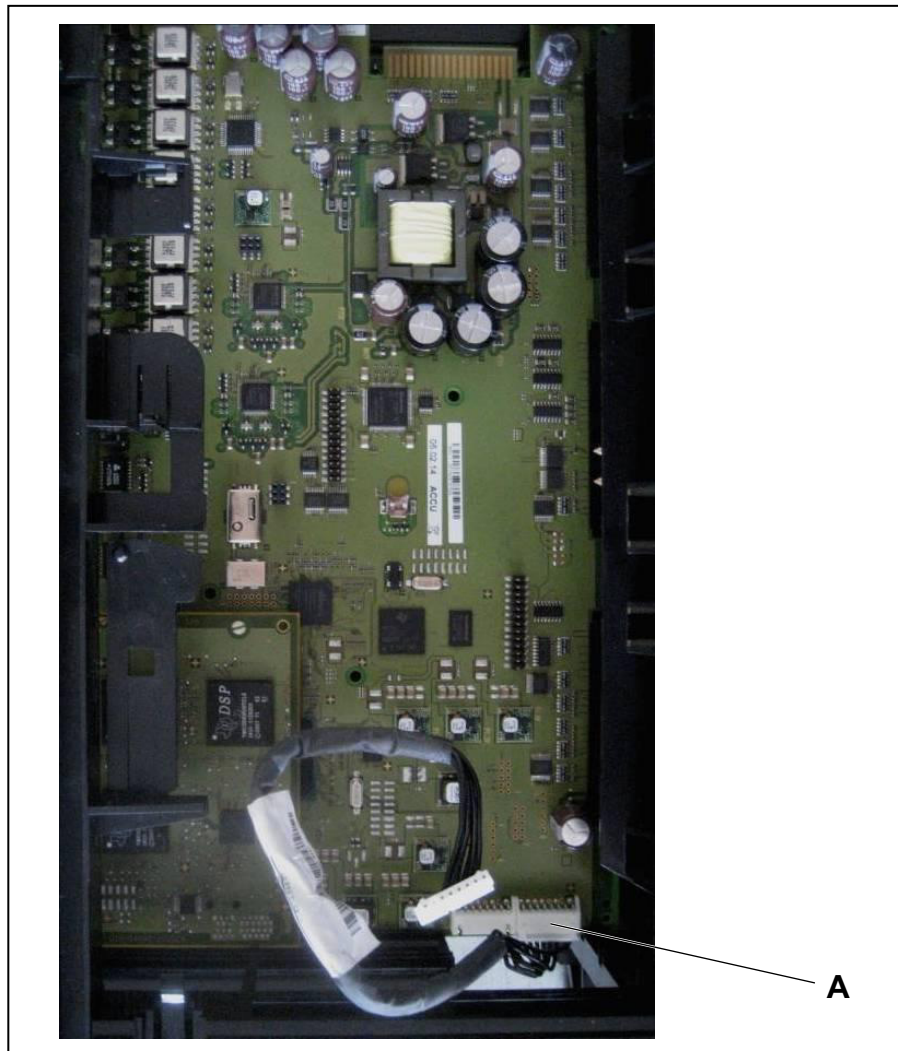
---



- 5) Install the OCAB:
  - a) Insert the connection cable supplied with the UC Booster Card OCAB into the X13 connector (A) on the OCCM mainboard.

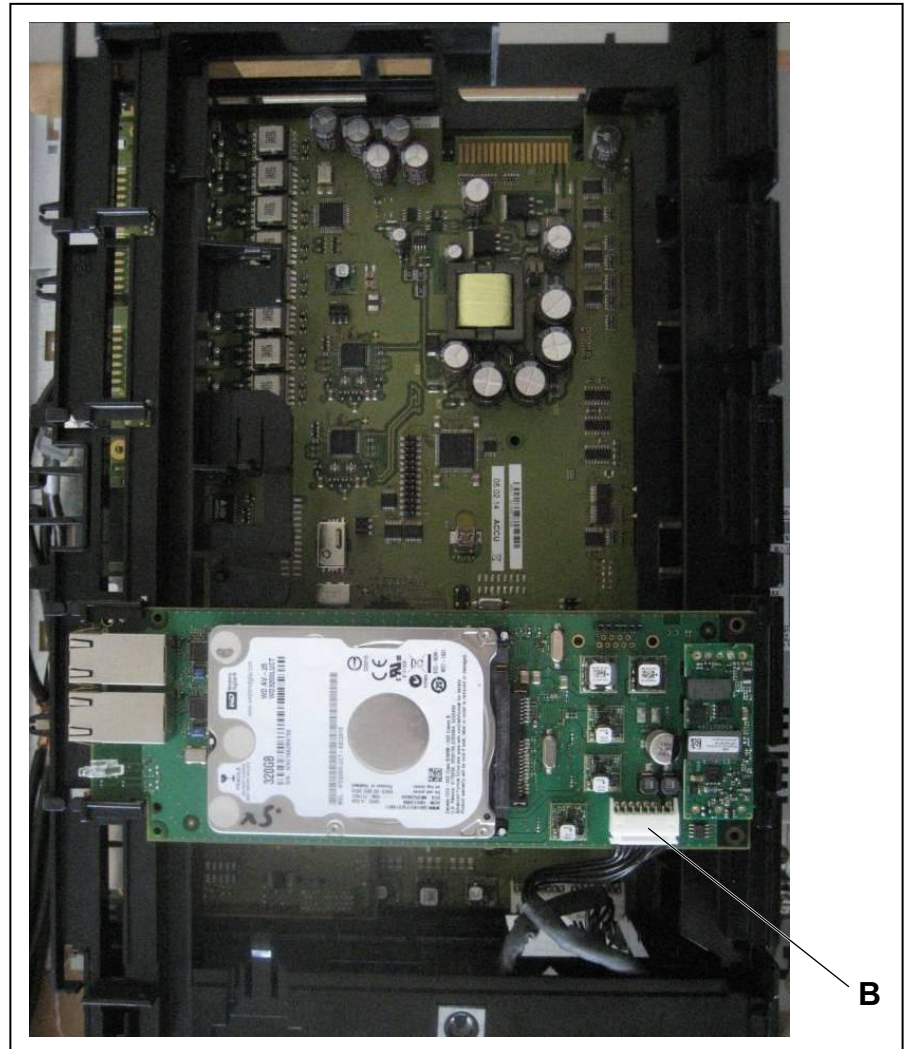
## Boards

### Description of the Boards



- b)** Install the UC Booster Card OCAB with the hard drive facing upwards in option 2, 3 or 4 on the slot level 3 for the X3W or in option 3 or 4 on the slot level 5 for the X5W (recommended).
- c)** Insert the connection cable into the X4 connector (B) of the UC Booster Card. Stow the cable in the board frame so that the cable does not hinder the fan and restrict the air flow.



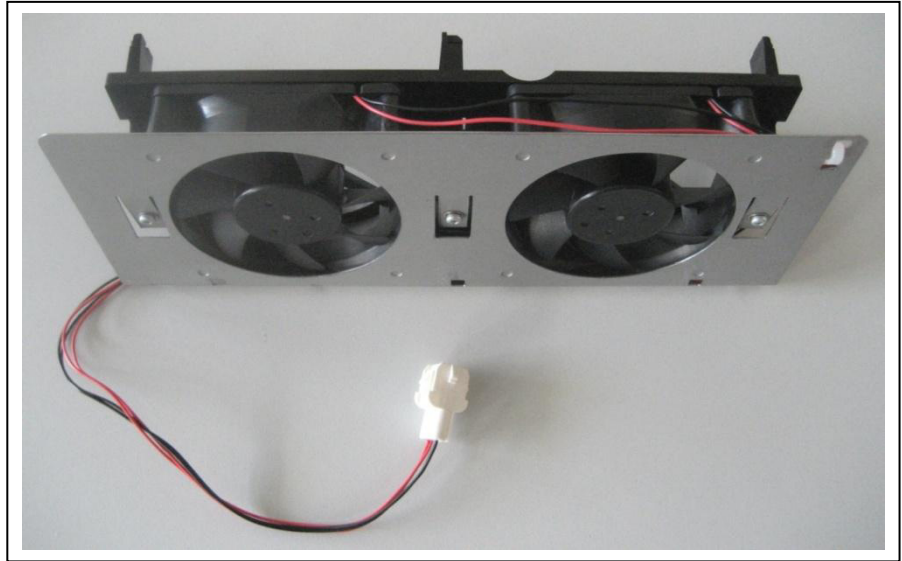


- 6) **Only when migrating from HiPath 3000:** If multiple SLAD16 boards are installed in the system, the possibly existing fan kit C39165-A7021-B46 must be removed.
- 7) **Only when migrating from HiPath 3000:** To connect the fan power cable to the power supply, a UPSC-D S30122-K5660-A301 with a 48V connection is required.
- 8) **Only for X3W with CUP Backplane:** Mount the fan kit:
  - a) Lock the fan kit with the snap hooks to the bottom of the board frame. The arrows on the fan housing point into the system, i.e., the cold air must be blown into the system.

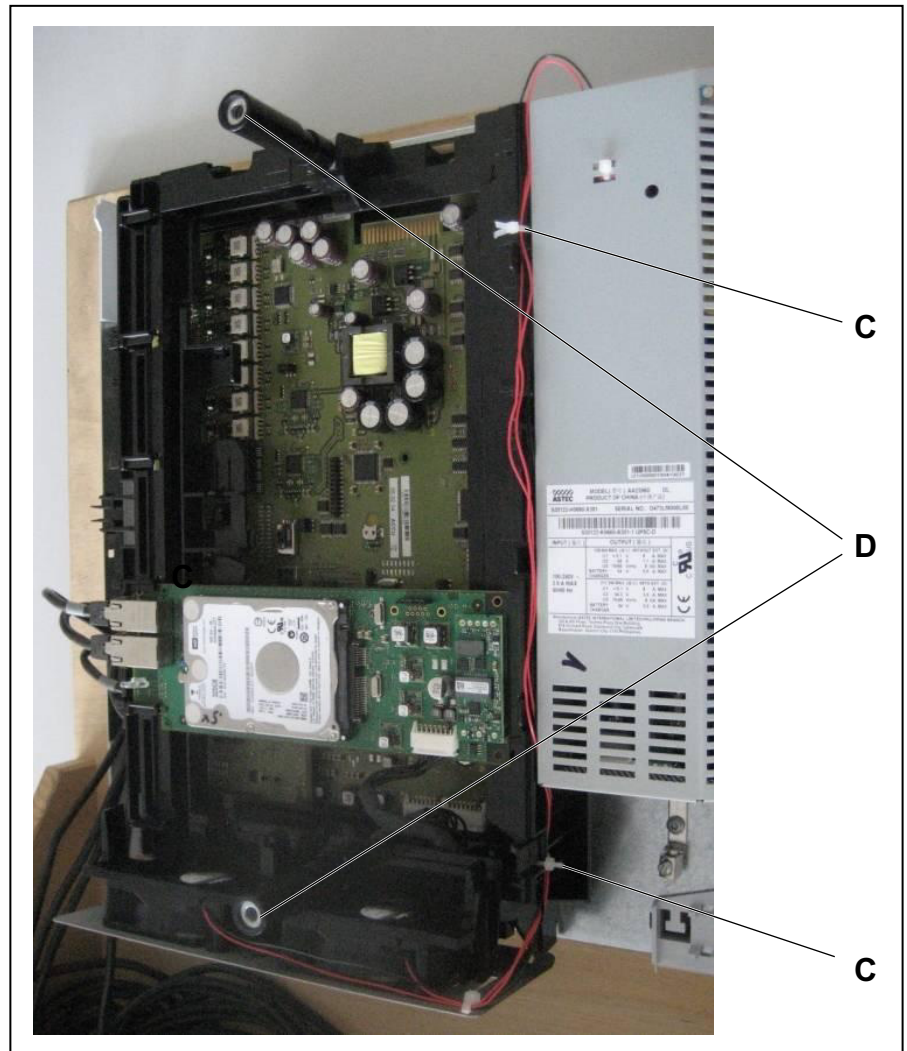
## Boards

### Description of the Boards

**Figure:** Fan Kit (C39165-A7021-8310) for system with CUP Backplane (S30777-Q751-x)





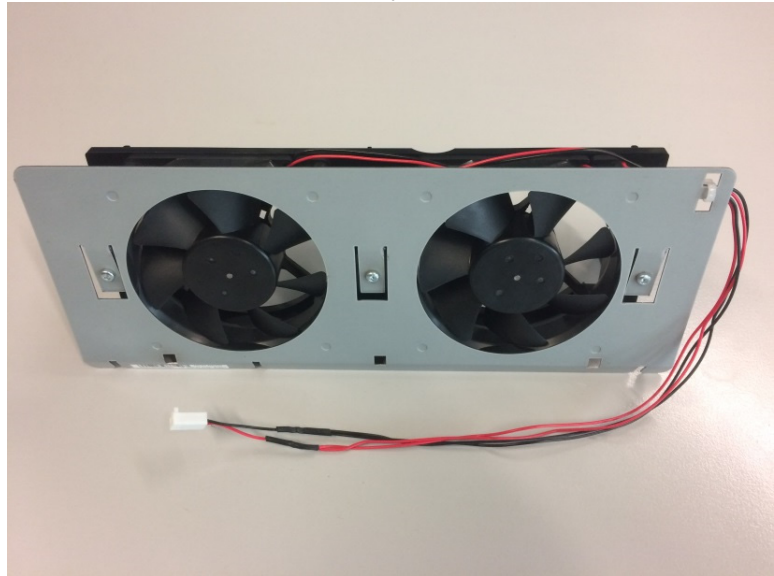


- b)** Fix the fan power cable to the housing with the two cable ties (C) supplied.
  - c)** Attach the two spacers of the adapter kit with a rotary motion of 90 degrees to the board frame (D).
  - d)** Connect the fan power cable to the open side of the power supply.
- 9) Only for X3W with CUX3W Backplane:** Mount the fan kit:
- a)** Lock the fan kit with the snap hooks to the bottom of the board frame. The arrows on the fan housing point into the system, i.e., the cold air must be blown into the system.

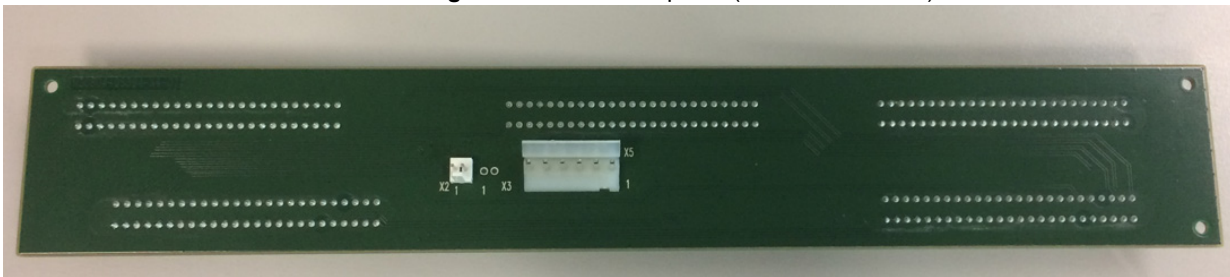
## Boards

### Description of the Boards

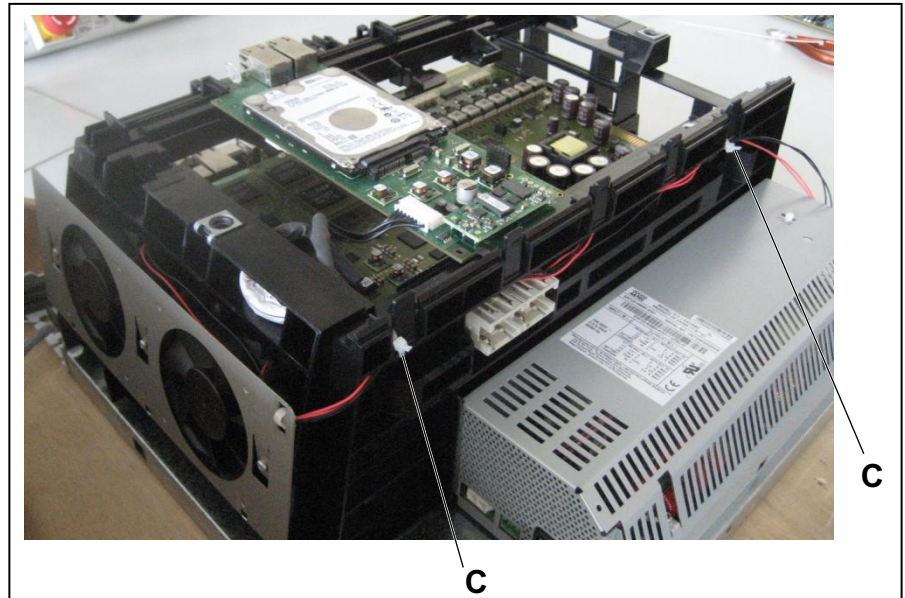
**Figure:** Fan Kit (C39165-A7021-B320) for systems with CUX3W Backplane



**Figure:** CUX3W Backplane (S30804-Q5394-X)



- b)** Unmount the OSPSM power supply and connect the fan kit cable to the connector X2 of the CUX3W backplane.
- c)** Mount OCPSM
- d)** Fix the fan power cable to the housing with the two cable ties (C) supplied.



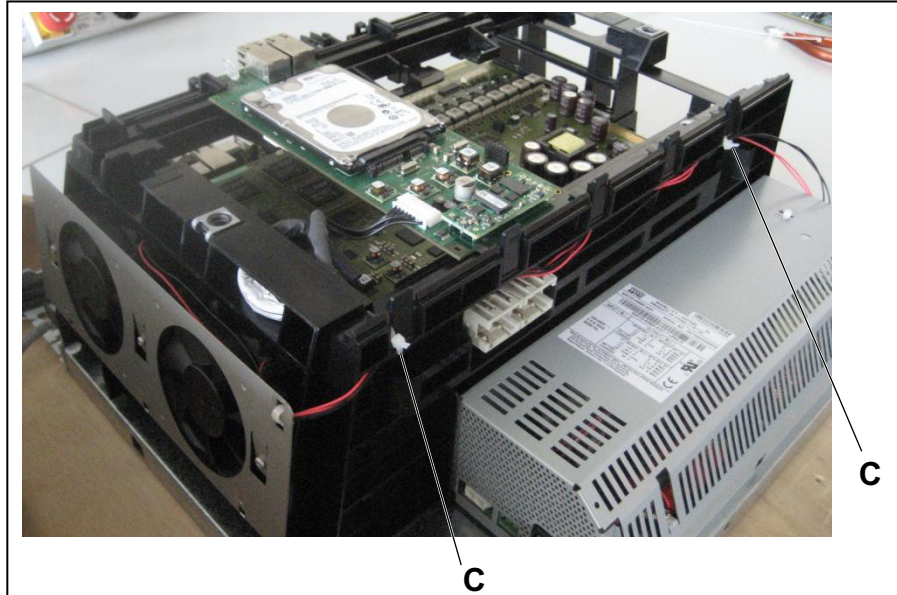
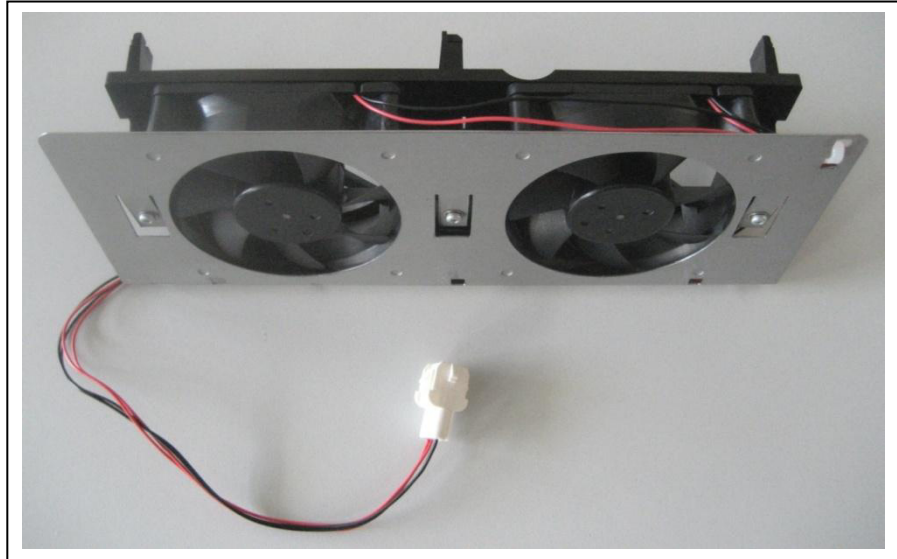
**10) Only for X5W with CUC Backplane:** Mount the fan kit:

- a) Lock the fan kit with the snap hooks to the bottom of the board frame. The arrows on the fan housing point into the system, i.e., the cold air must be blown into the system.

## Boards

### Description of the Boards

**Figure:** Fan Kit (C39165-A7021-B310) for systems with CUC Backplane



**b)** Fix the fan power cable to the housing with the two cable ties (C) supplied.

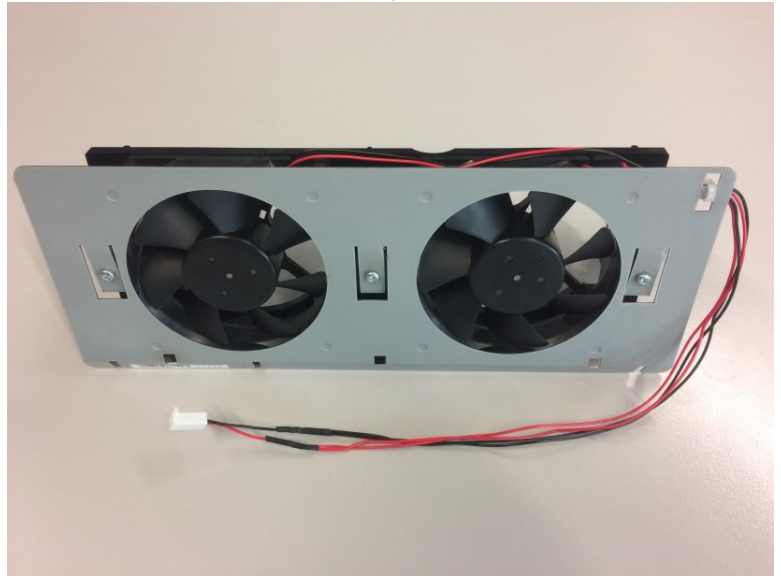
**c)** Connect the fan power cable to the open side of the power supply.

**11) Only for X5W with CUX5W Backplane:** Mount the fan kit:

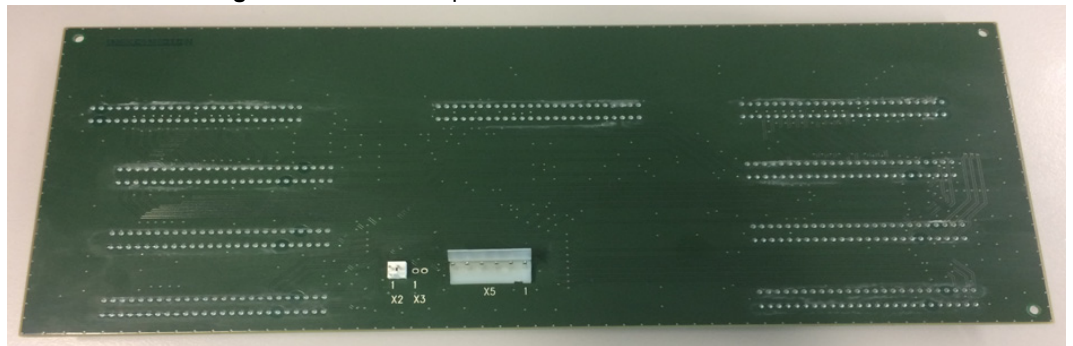
**a)** Lock the fan kit with the snap hooks to the bottom of the board frame. The arrows on the fan housing point into the system, i.e., the cold air must be blown into the system.



**Figure:** Fan Kit (C39165-A7021-B320) for systems with CUX5W Backplane



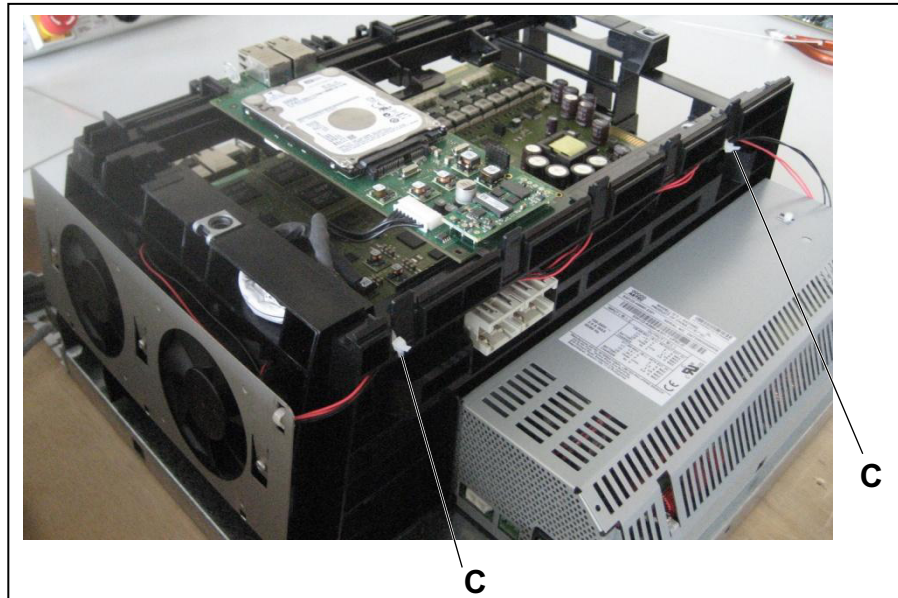
**Figure:** CUX5W Backplane



- b)** Unmount the OSPSM power supply and connect the fan kit cable to the connector X2 of the CUX5W backplane.
- c)** Mount OCPSM.
- d)** Fix the fan power cable to the housing with the two cable ties (C) supplied.

## Boards

### Description of the Boards



- 12) Only for migration from HiPath 3000:** Remove the plastic cover for the V24 interface from the housing frame. Otherwise, the new housing cover cannot be mounted.
- 13)** Put on the new housing cover. Make sure that the two recesses in the housing cover are facing downward.
- 14)** Secure the housing cover with the two screws. Make sure that you only touch the outside of the housing cover. The shielding plate on the inside of the housing cover may have sharp edges which can cause cuts.
- 15)** Put the communication system into operation (see the section "Initial Installation of OpenScape Business X3/X5/X8" in the OpenScape Business Administrator Documentation).

### 3.2.16.3 How to Mount the OCAB and the Fan Kit in an X3R or X5R System

In addition, the UC Booster Card needs a more powerful fan kit with fans that must be mounted within the X3R or X5R housing. **Required Packages**

UC Booster Card (S30807-K6950-X):

- 1 OCAB (UC Booster Card)
- 1 OCAB - OCCMR connection cable
- 2 x 2 Torx screws

C39117-A7003-B611:

- 1 fan unit consisting of 2 fans
- 1 fan bracket
- 1 Torx screw for the fan bracket
- 2 cable ties

for X5R (C39117-A7003-B612):

- 1 fan unit consisting of 2 fans
- 2 x 2 Torx screws for the fan
- 1 fan bracket
- 1 Torx screw for the fan bracket
- 3 cable ties



#### **DANGER**

##### **Risk of electric shock through contact with live wires**

Disconnect all power supply circuits of the communication system before removing the OCCMR mainboard:

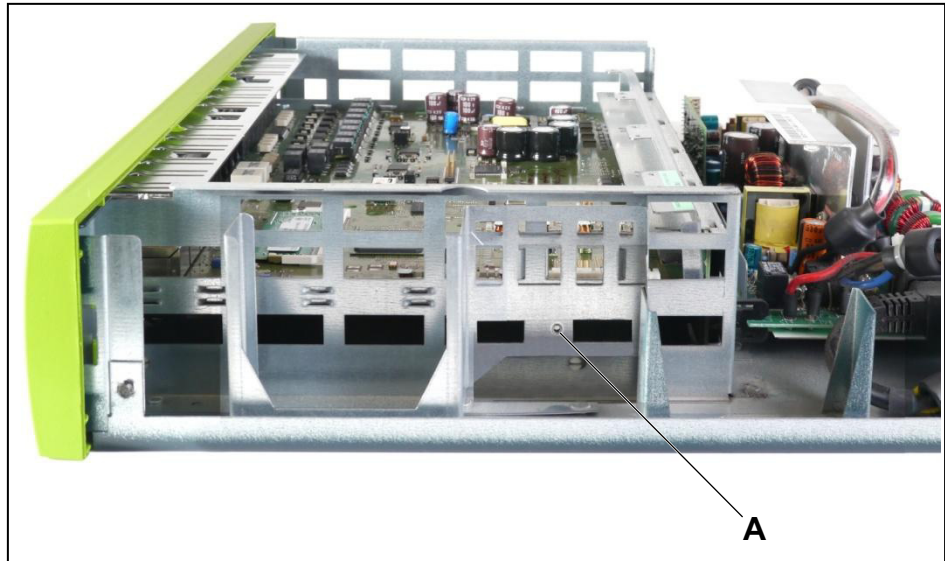
- Disconnect the battery voltage, supply voltage and line voltage at any connected OpenScape Business Powerbox.
  - Disconnect the line cords of any connected battery pack or any connected batteries.
  - Disconnect the power plug of the communication system.
- 

#### ***Step by Step***

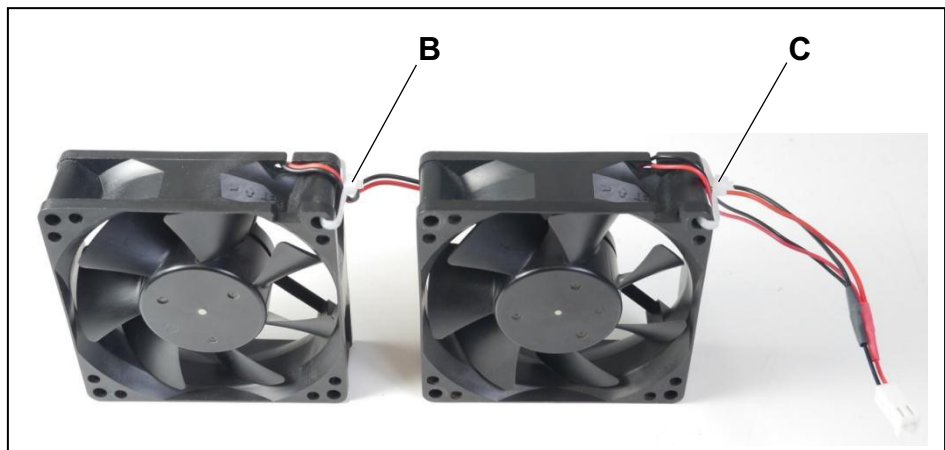
- 1) Disconnect all power supply circuits of the communication system.
- 2) Make sure that the communication system is de-energized.
- 3) **Only for X3R:** Mount the X3R fan kit:
  - a) If the system is installed in a 19" rack, remove the system from the 19" rack.
  - b) Using a T20 Torx screwdriver, remove the screws and lift off the cover.
  - c) Disconnect the fan power cable from the backplane. To do this, push the small white lever on the socket down and pull off the plug.
  - d) Pull the old fan out upwards. If it is jammed and difficult to move, use a screwdriver as a lever.
  - e) Clamp the fan bracket laterally to the frame housing and secure the bracket with the supplied screw (A).

## Boards

### Description of the Boards



- f)** First, fix the fan power cable to the fans using the two supplied cable ties (B and C). If the fans are placed in the brackets before fixing the power cable, it is very difficult to insert the cable ties into the fan.



- g)** Insert the two new fans into the brackets provided for this purpose. Pay special attention to the correct air flow direction, which is indicated by arrows on the fan housing (the arrows point into the system, i.e., the cold air must be blown into the system).

The power cable of the front fan must be routed under the rear fan (D)!

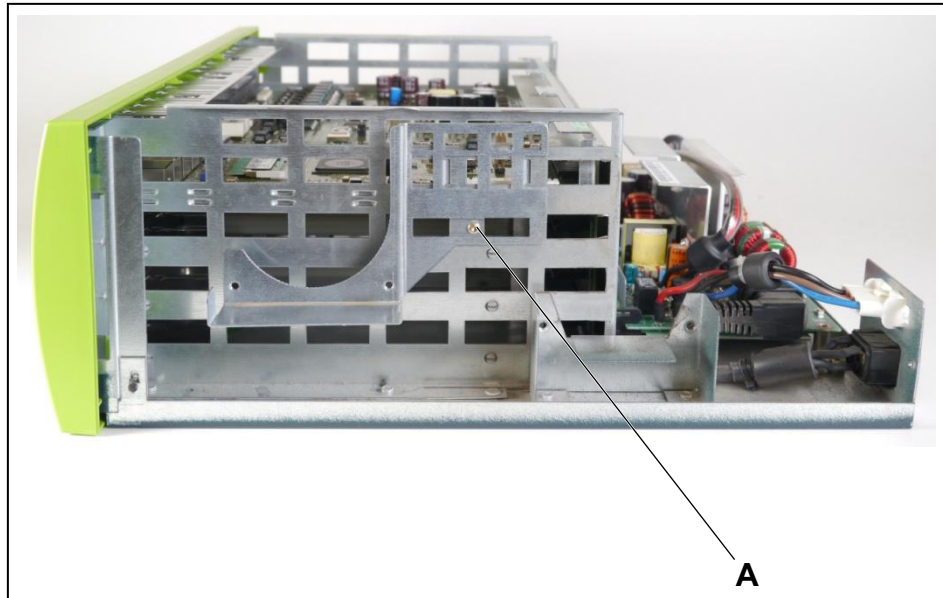




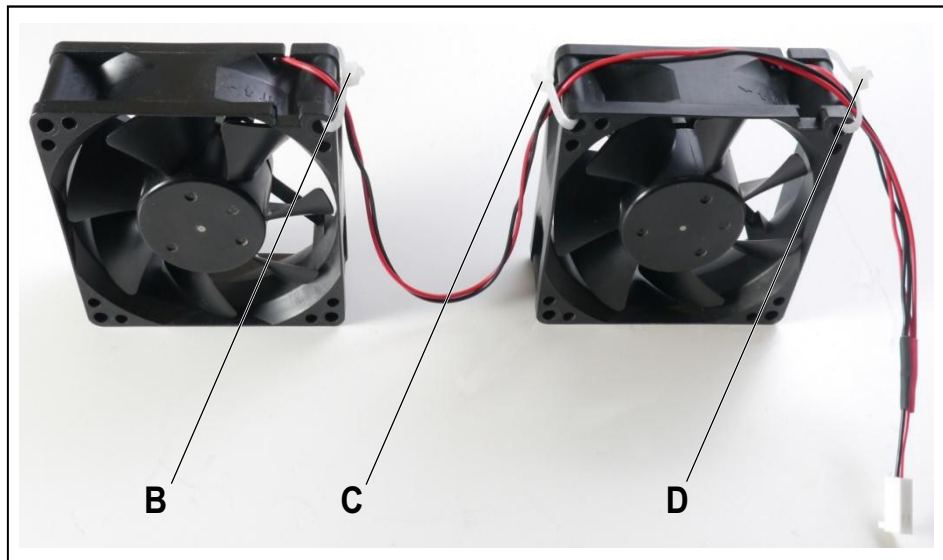
- h)* Connect the new fan power cable to the socket, where the old fan power cable was previously plugged.
- 4) Only for X5R:** Mount the X5R fan kit:
- a)* If the system is installed in a 19" rack, remove the system from the 19" rack.
  - b)* Using a T20 Torx screwdriver, remove the screws and lift off the cover.
  - c)* Disconnect the fan power cable from the backplane. To do this, push the small white lever on the socket down and pull off the plug.
  - d)* Remove the two screws of the fan and pull out the old fan by sliding it upwards.
  - e)* Clamp the fan bracket laterally to the frame housing and secure the bracket with the supplied screw (A).

## Boards

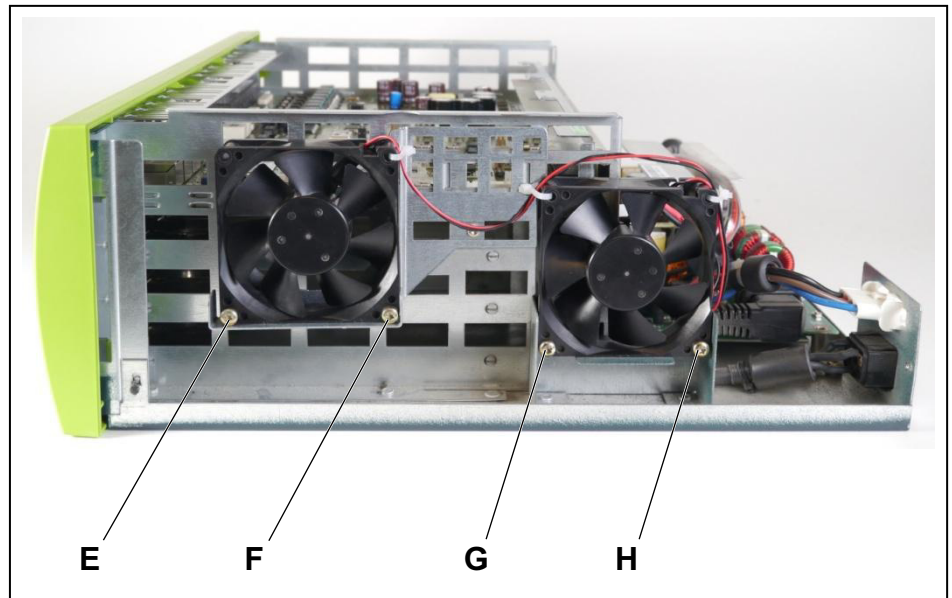
### Description of the Boards



- f)** First, fix the fan power cable to the fans using the three supplied cable ties (B, C and D). If the fans are placed in the brackets before fixing the power cable, it is very difficult to insert the cable ties into the fan.



- g)** Insert the two new fans into the brackets provided for this purpose and fix the fans to the brackets with the supplied screws (E, F, G and H). Pay special attention to the correct air flow direction, which is indicated by arrows on the fan housing (the arrows point into the system, i.e., the cold air must be blown into the system).



*h)* Connect the new fan power cable to the backplane socket, where the old fan power cable was previously plugged.

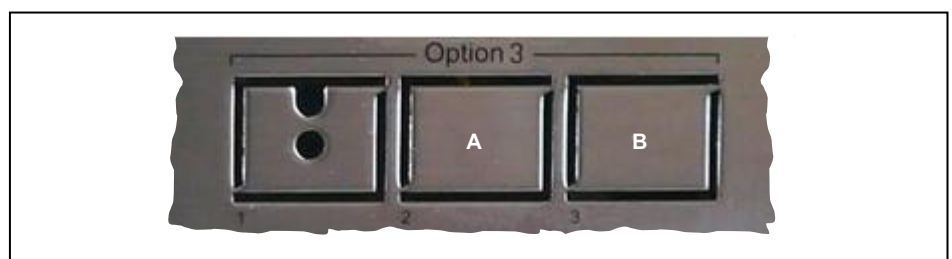
**5)** Install the OCAB:

- a)* Loosen the two locking screws in the front panel of the OCCMR mainboard.
- b)* Loosen the OCCMR mainboard from the backplane using two board wrenches (C39165-A7027-C26).
- c)* Gently pull out the OCCMR mainboard with both hands horizontally from the board shelf and place it on a flat, grounded conductive surface.
- d)* Carefully remove the protection shields marked in the figure with [A] and [B] from the front panel of the OCCMR mainboard for Option 3.

---

**INFO:** The UC Booster Card may also be installed in Option 2, though Option 3 ensures better ventilation.

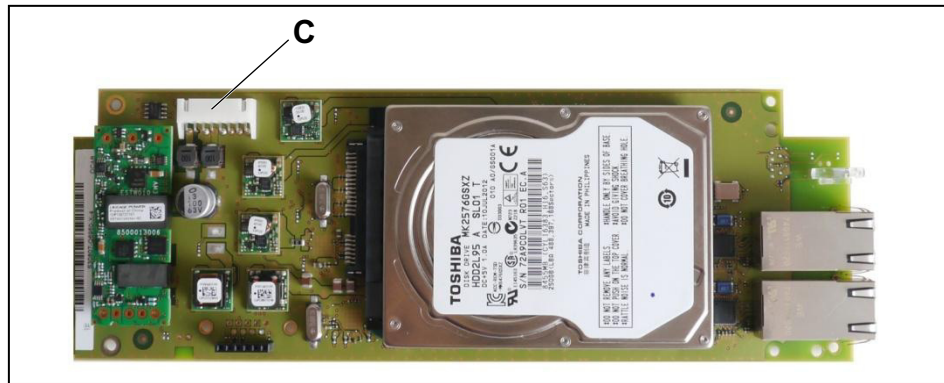
---



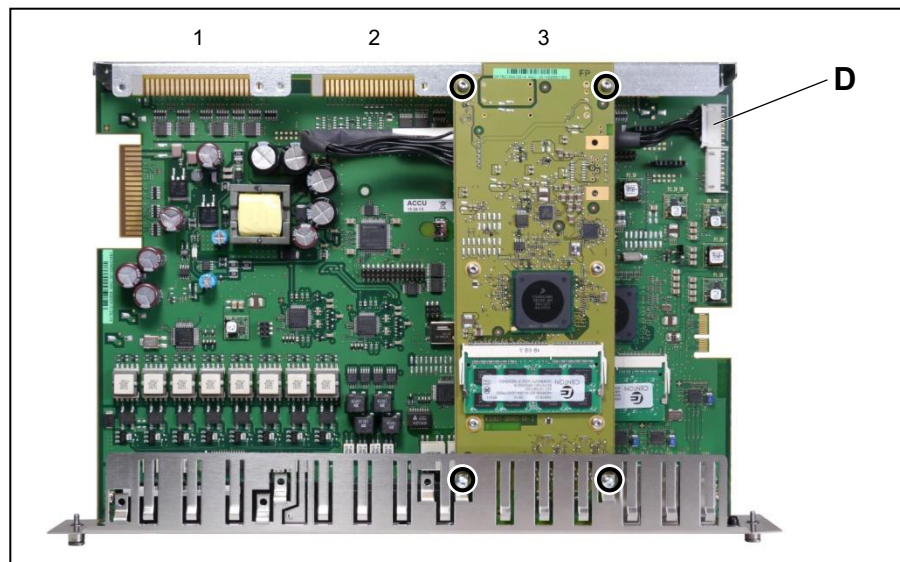
*e)* Insert the connection cable supplied with the UC Booster Card OCAB into the X4 connector (C) of the UC Booster Card.

## Boards

### Description of the Boards



- f)** Install the UC Booster Card OCAB with the hard drive at the bottom on the OCCMR mainboard in option 3. It is important that the UC Booster Card rests on the bracket at the back and under the mounting tabs at the front. When doing this, make sure that the two LEDs on the UC Booster Card protrude through the front panel of the mainboard.
- g)** Fix the UC Booster Card OCAB at the marked locations in the following figure with 2 x 2 screws to the metal panel of the OCCMR mainboard.



- h)** Insert the connecting cable into the X20 connector (D) of the OCCMR mainboard.
  - i)** Slide the OCCMR mainboard back into its slot on the shelf.
  - j)** Attach the OCCMR mainboard to the shelf using the two locking screws.
- 6)** If the system was installed in a 19" rack, put the system back into the 19" rack.
- 7)** Screw on the housing cover again.

---

**INFO:** If you have migrated from a HiPath 3300 or HiPath 3500, you will need a new housing cover with additional air vents (X3R: C39165-A7027-B257 / X5R: C39165-A7027-B207).

---

- 8) Put the communication system into operation (see the section "Initial Installation of OpenScape Business X3/X5/X8" in the OpenScape Business Administrator Documentation).

### 3.2.17 OCCB1, OCCB3

The UC Voice Channel Booster Cards OCCB1 and OCCB3 (OpenCore Channel Booster) are optional subboards for the central control boards OCCM (OpenScape Business X3W and X5W) OCCMR (OpenScape Business X3R and X5R) and OCCL (OpenScape Business X8).

If the number of digital signal processors (DSPs) provided on a central control board is insufficient, additional DSPs can be provided by inserting an OCCB subboard.

- OCCB1  
Provides an additional DSP for additional DSP channels (gateway channels).
- OCCB3  
Provides three additional DSPs for additional DSP channels (gateway channels).

#### Board Variants and their Use

Board	Part Number	Used in		Maximum number
		Communication system	Country	
OCCB1	S30807-Q6949-X100	OpenScape Business X3R OpenScape Business X3W OpenScape Business X5R OpenScape Business X5W OpenScape Business X8	ROW	1
OCCB3	S30807-Q6949-X	OpenScape Business X8	ROW	1

The OCCB subboards have a PCI-E jack (X1) which is plugged into the associated edge connector of the central control board:

- OCCL: edge connector X6, see [How to Install OCCB1/OCCB3 on OCCL](#)



## Boards

### Description of the Boards

- OCCM: edge connector X11, see [How to Install OCCB1/OCCB3 on OCCM](#)
- OCCMR: edge connector X18, see [How to Install OCCB1/OCCB3 on OCCMR](#)

---

**NOTICE:** Place the mainboard on a flat, grounded and conducting surface before inserting the subboard. Otherwise you may damage the mainboard.

In the default factory state, the subboard has two spacing bolts inserted to ensure the correct positioning of the subboard on the mainboard.

---

### Figure

Figure: OCCB1 - component side with inserted spacing bolts

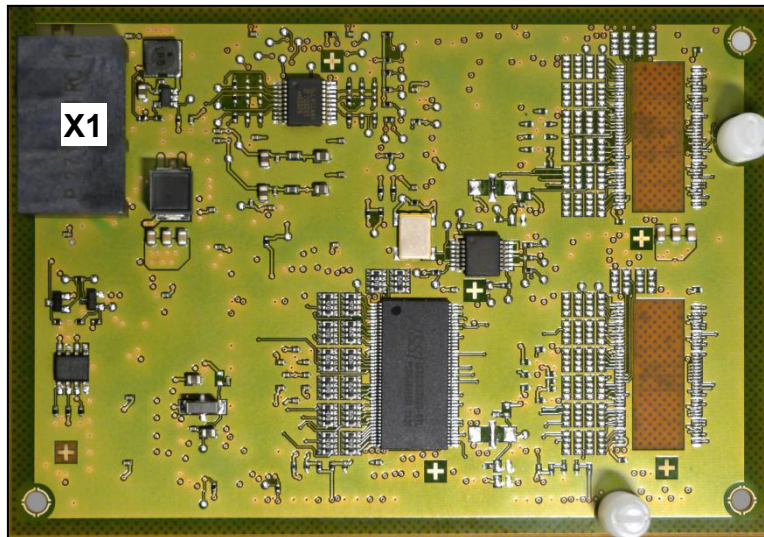
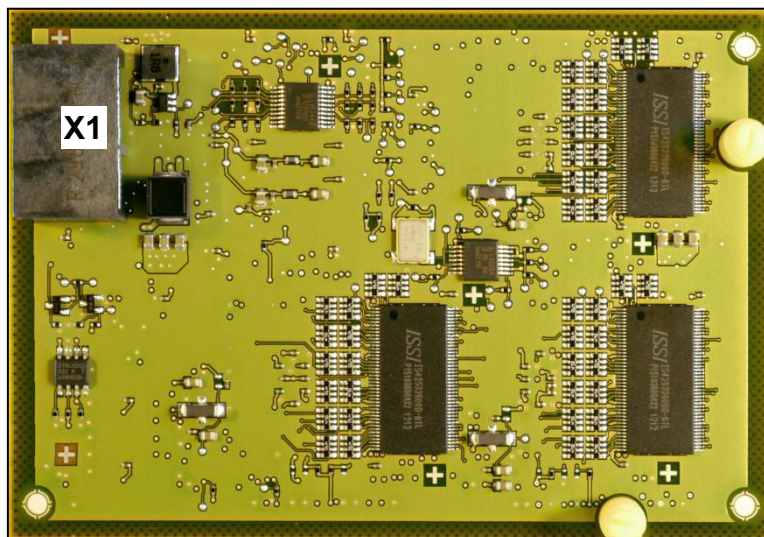


Figure: OCCB3 - component side with inserted spacing bolts



### 3.2.17.1 How to Install OCCB1/OCCB3 on OCCL



#### **DANGER**

#### **Risk of electric shock through contact with live wires**

Disconnect all power supply circuits of the communication system before removing the OCCL mainboard:

- Disconnect the battery voltage, supply voltage and line voltage at any connected OpenScape Business Powerbox.
  - Disconnect the line cords of any connected battery pack or any connected batteries.
  - Disconnect all power plugs of the communication system.
- 

#### **Step by Step**

- 1) Disconnect all power supply circuits of the communication system.
- 2) Make sure that the communication system is de-energized.
- 3) Remove the front plastic cover of the base box.
- 4) Insert the tip of the board wrench marked "Pull" into the top opening in the front cover of the OCCL mainboard.
- 5) Lever the OCCL mainboard out of the board shelf of the base box by pushing the board wrench upwards.
- 6) Pull out the OCCL mainboard from the board shelf and place it on a flat, grounded conductive surface.

---

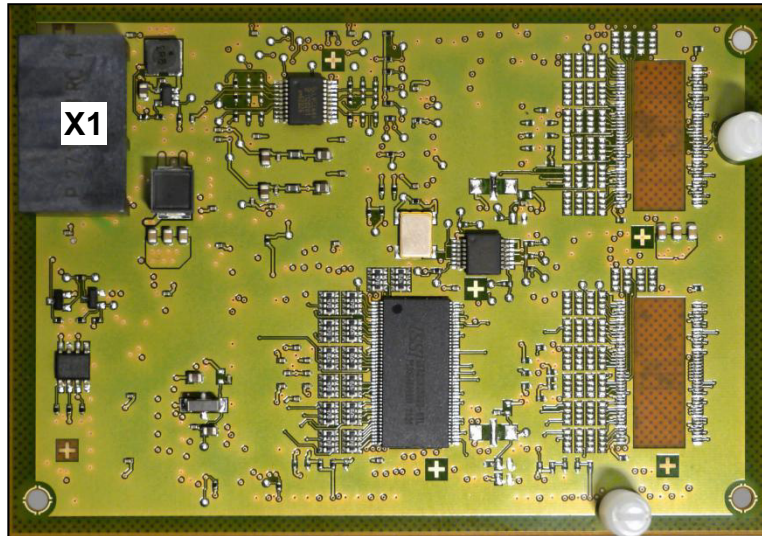
**INFO:** In the default factory state, the OCCB1 and OCCB3 subboards already have the spacing bolts inserted.

---

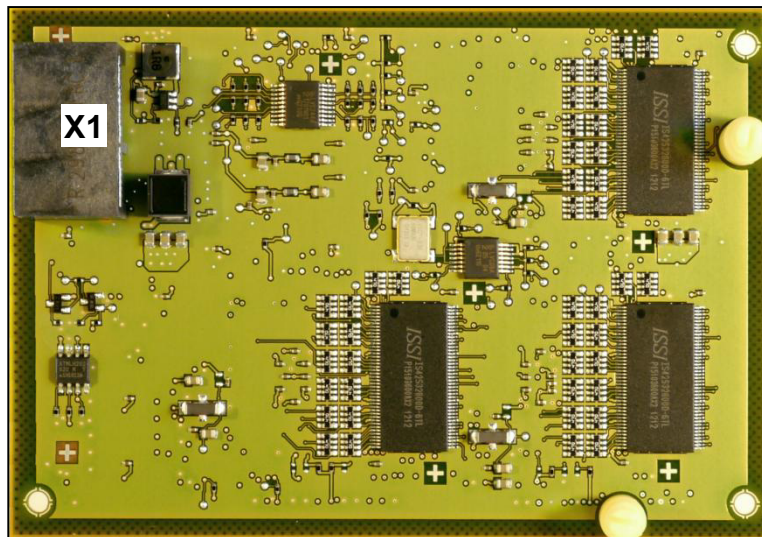
## Boards

### Description of the Boards

**Figure:** OCCB1 - Component side with inserted spacing bolts



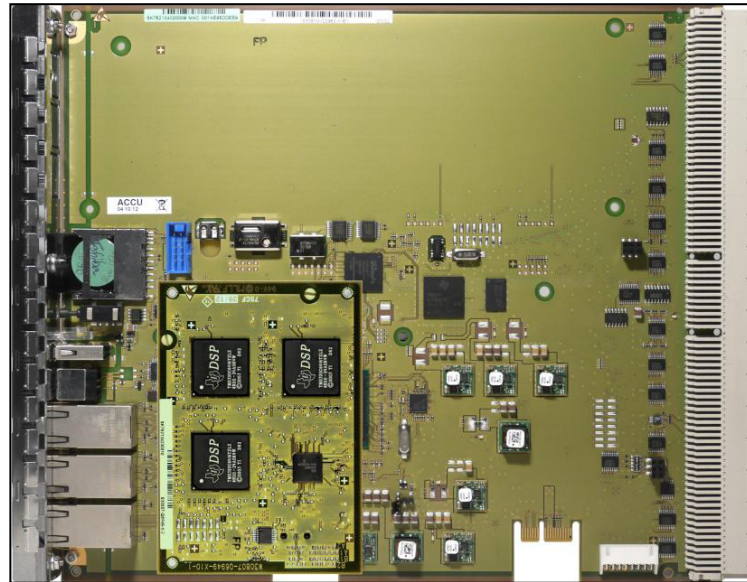
**Figure:** OCCB3 - component side with inserted spacing bolts



- 7) Insert the PCI-E connector X1 of the OCCB subboard (component side down) onto the X6 edge connector of the OCCL mainboard. Make sure that the two spacing bolts are plugged into the appropriate holes on the mainboard.



**Figure:** OCCB subboard mounted on OCCL



- 8) Using its guide rails, slide the OCCL mainboard back into the appropriate slot on the base box shelf.
- 9) Insert the tip of the board wrench marked "Plug-In" into the bottom opening in the front cover of the OCCL mainboard.
- 10) Lever the mainboard into the board shelf of the base box by pushing the board wrench upwards.
- 11) Close the base box with the plastic cover provided for this purpose.
- 12) Place the communication system back into operation.

### 3.2.17.2 How to Install OCCB1/OCCB3 on OCCM



---

#### **DANGER**

##### **Risk of electric shock through contact with live wires**

Disconnect all power supply circuits of the communication system before opening the housing:

- Disconnect the battery voltage, supply voltage and line voltage at any connected OpenScape Business Powerbox.
  - Disconnect the line cords of any connected battery pack or any connected batteries.
  - Disconnect the power plug of the communication system.
-

## Boards

### Description of the Boards

#### Step by Step

- 1) Disconnect all power supply circuits of the communication system.
- 2) Make sure that the communication system is de-energized.
- 3) Loosen the two fixing screws on the housing cover with a slotted screw driver. Hold the housing cover so that it does not fall.



- 4) Remove the housing cover.



---

#### CAUTION

##### Cuts caused by sharp edges on the shielding plate

Make sure that you only touch the outside of the housing cover. The shielding plate on the inside of the housing cover may have sharp edges which can cause cuts.

---



- 5) Remove the stabilizer cap.
- 6) Pull out the OCCM mainboard from the board shelf and place it on a flat, grounded conductive surface.

---

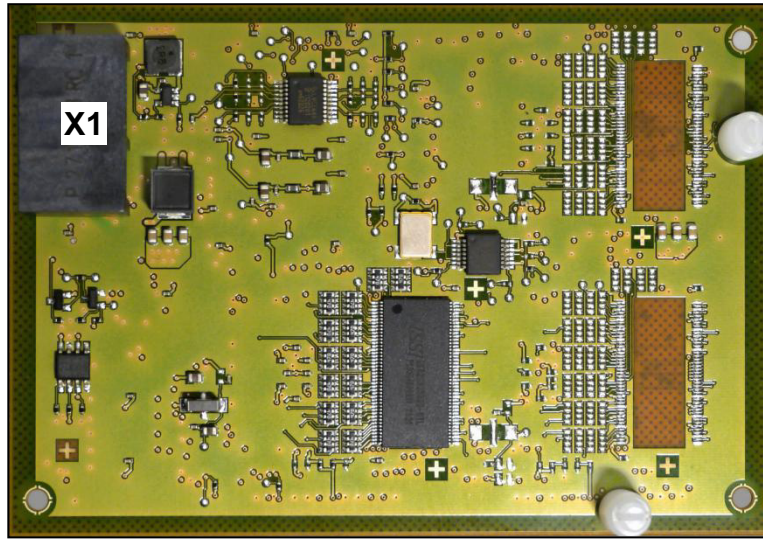
**INFO:** In the default factory state, the OCCB1 and OCCB3 subboards already have the spacing bolts inserted.

---

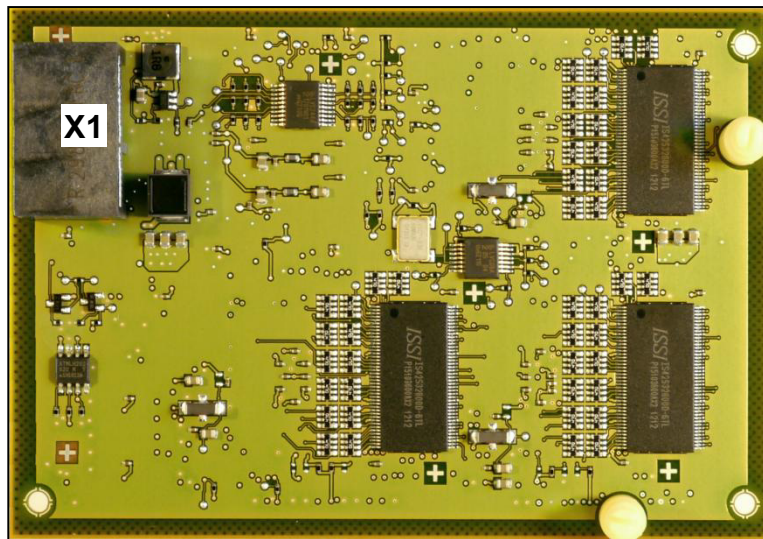
## Boards

### Description of the Boards

**Figure:** OCCB1 - Component side with inserted spacing bolts



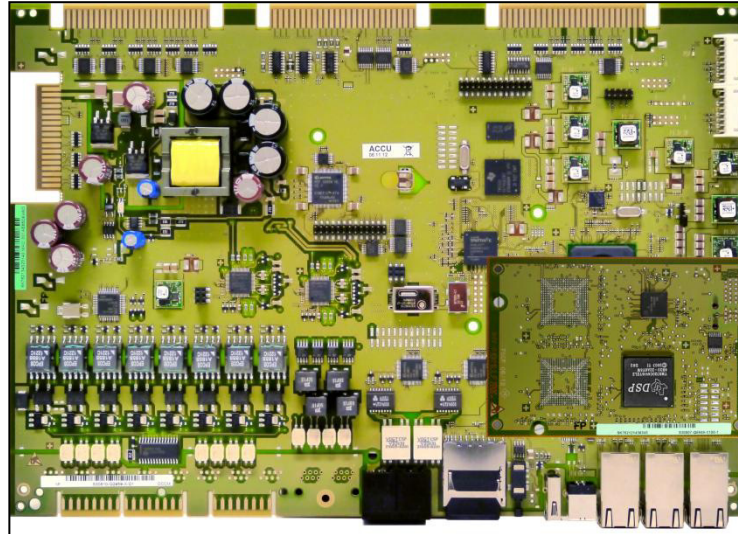
**Figure:** OCCB3 - component side with inserted spacing bolts



- 7) Insert the PCI-E connector X1 of the OCCB subboard (component side down) onto the X11 edge connector of the OCCM mainboard. Make sure that the two spacing bolts are plugged into the appropriate holes on the mainboard.



**Figure:** OCCB subboard mounted on OCCM



- 8) Slide the OCCM mainboard back into the slot that is provided on the board frame for this purpose.
- 9) Mount the stabilizer cap.
- 10) Close the housing. To do this, put the housing cover on and secure it with the two fixing screws. Make sure that you only touch the outside of the housing cover. The shielding plate on the inside of the housing cover may have sharp edges which can cause cuts.
- 11) Place the communication system back into operation.

### 3.2.17.3 How to Install OCCB1/OCCB3 on OCCMR



---

#### **DANGER**

##### **Risk of electric shock through contact with live wires**

Disconnect all power supply circuits of the communication system before removing the OCCMR mainboard:

- Disconnect the battery voltage, supply voltage and line voltage at any connected OpenScape Business Powerbox.
  - Disconnect the line cords of any connected battery pack or any connected batteries.
  - Disconnect the power plug of the communication system.
-

## Boards

### Description of the Boards

#### Step by Step

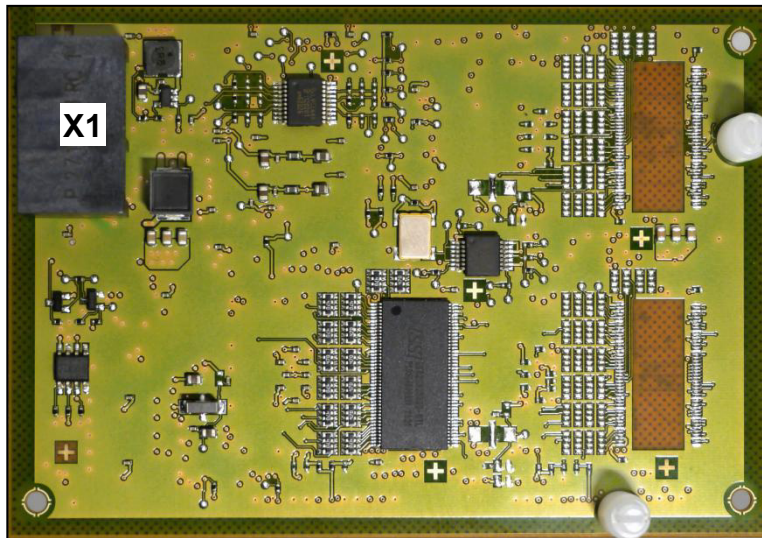
- 1) Disconnect all power supply circuits of the communication system.
- 2) Make sure that the communication system is de-energized.
- 3) Loosen the two locking screws in the front panel of the OCCMR mainboard.
- 4) Loosen the OCCMR mainboard from the backplane using two board wrenches (C39165-A7027-C26).
- 5) Gently pull out the OCCMR mainboard with both hands horizontally from the board shelf and place it on a flat, grounded conductive surface.

---

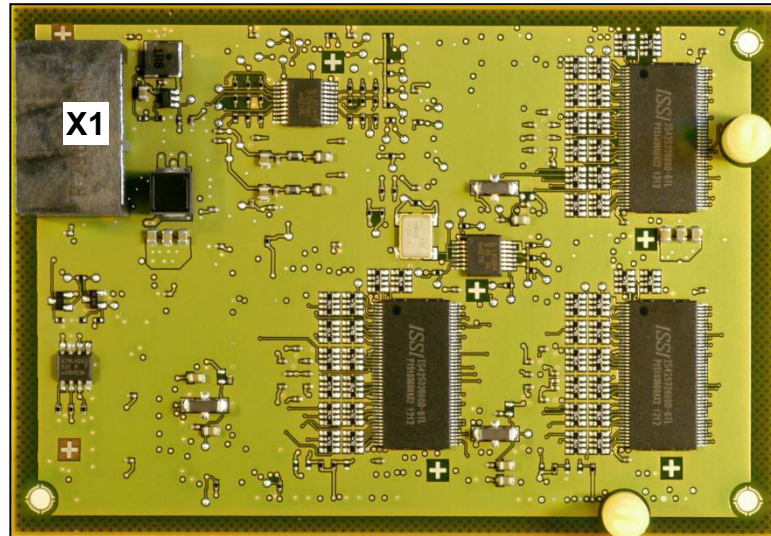
**INFO:** In the default factory state, the OCCB1 and OCCB3 subboards already have the spacing bolts inserted.

---

**Figure:** OCCB1 - Component side with inserted spacing bolts

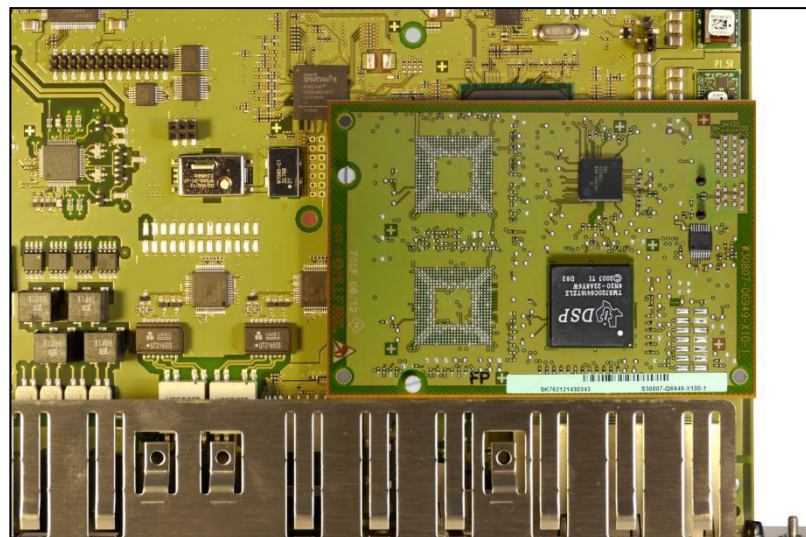


**Figure:** OCCB3 - component side with inserted spacing bolts



- 6) Insert the PCI-E connector X1 of the desired OCCB subboard (component side down) onto the X18 edge connector of the OCCMR mainboard. Make sure that the two spacing bolts are plugged into the appropriate holes on the mainboard.

**Figure:** OCCB subboard mounted on OCCMR



- 7) Carefully slide the OCCM mainboard with both hands horizontally back into the slot that is provided on the board frame for this purpose.
- 8) Attach the OCCMR mainboard to the shelf using the two locking screws.
- 9) Place the communication system back into operation.

## Boards

### Description of the Boards

## 3.2.18 OCCL

OCCL (Open Core Controller Large) is the central control board (mainboard) of the OpenScape Business X8 communication system.

The SD card slot contains the SDHC (Secure Digital High Capacity) card with the current software of the communication system.

---

**NOTICE:** The SDHC card must never be removed or inserted while the communication system is up and running. Otherwise, there may be damage to the file system and thus result in the failure of the communication system.

---

### Board Variants and their Use

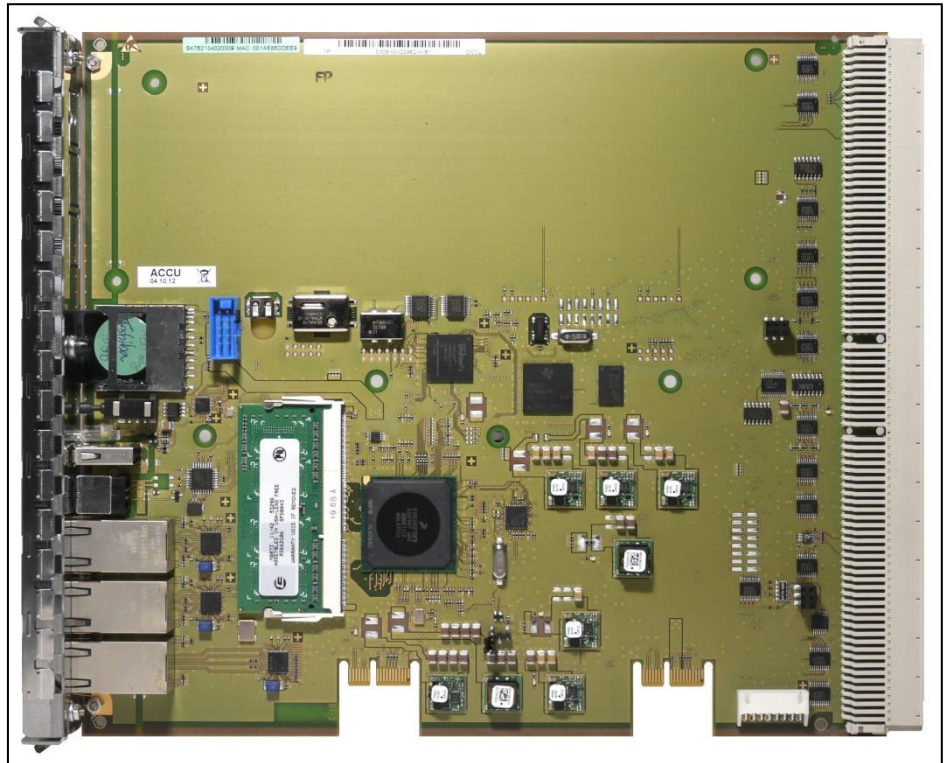
Board	Part Number	Used in		Maximum number
		Communication system	Country	
OCCL	S30810-K2962-X	OpenScape Business X8	ROW	1

The OCCL mainboard should only be plugged into slot 6 of a base box.

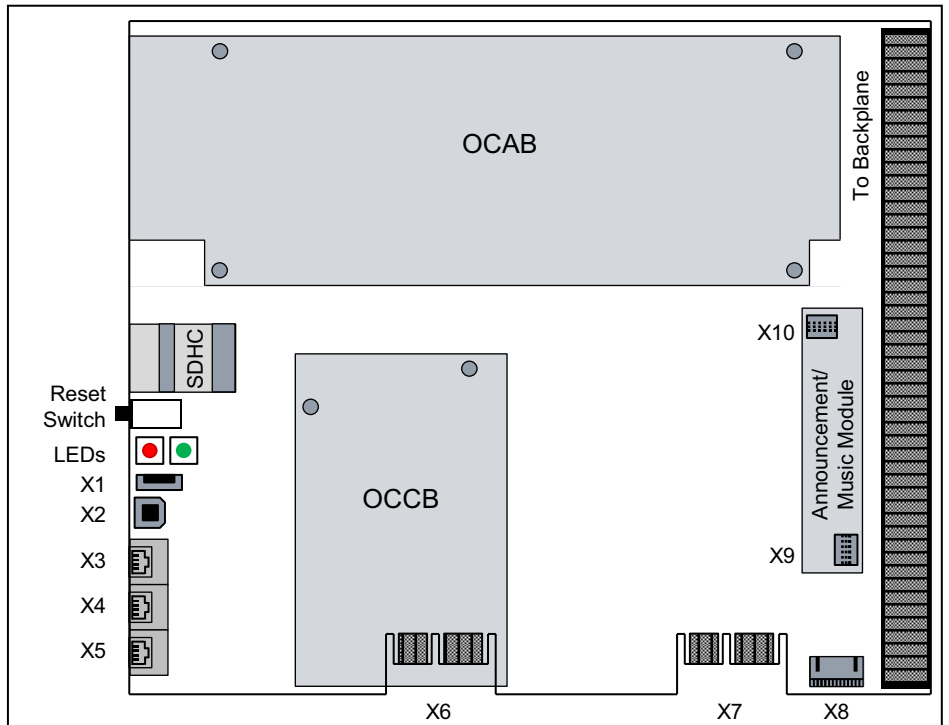


**Figure**

**Figure:** OCCL



**Figure:** OCCL - Connections



### Battery

There is a battery on the mainboard that is used to buffer the date and time.

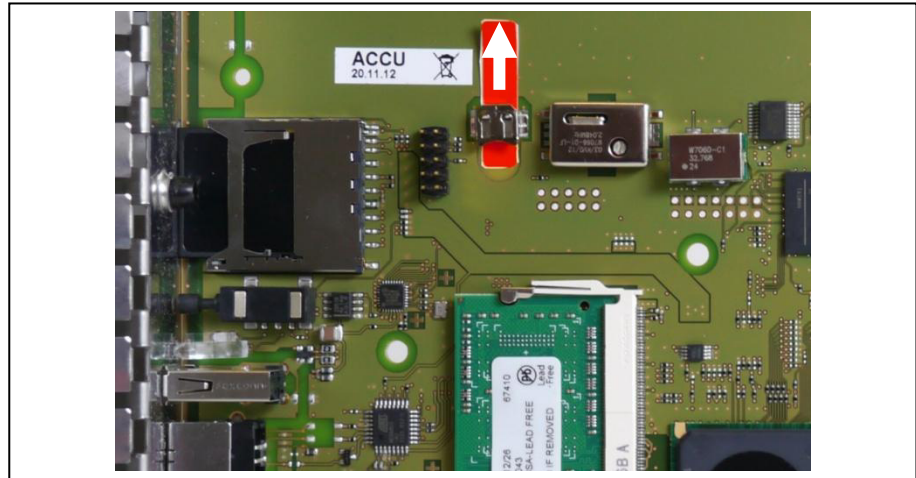
---

**NOTICE:** Before starting up the communication system, the battery must be activated. To do this, the protective film shown in the following figure must be removed.

In order to not loosen the battery, the protective film must be removed only at the closed side of the battery holder (indicated by arrow in the following figure).

---

**Figure:** OCCL - Battery with protective film



### Temperature Monitoring

The temperature of the system is monitored. At temperatures higher than 61 degrees Celsius, a notification can be sent to up to three system telephones with a display, by e-mail or through signaling via an SNMP trap. Entries are made in the event log and event viewer (client trace) only if the system exceeds or falls below the critical temperatures. Logging occurs in the message log so long as the value is less than or equal to 58° Celsius.

At temperatures above 66 °C, the message "Alarm: critical system temperature!" is displayed on the home page of the OpenScope Business Assistant (WBM). Any existing SLAV/SLAD boards are switched off. Then, the system must be shut down and disconnected from the power supply. After checking the system and any existing SLAV/SLAD boards, the system can be reconnected to the power supply and restarted. The alarm is thus cleared, and the SLAV/SLAD boards are put back into operation.

### Connectors

- X 1 = USB control port (USB 1.1)  
To connect a PC for service and diagnostic purposes.
- X2 = USB server port (USB 2.0)  
For connecting an external hard disk or USB stick for backups and software upgrades.

- X3, X4, X5 = 3 Ethernet (10/100/1000 BaseT) ports (RJ45 jacks)  
Two LEDs indicate the current status of each Ethernet interface.

**Table:** OCCL – LEDs for Indicating the Ethernet Interface Status

Left LED (Speed)	Right LED (Link/Activity)	Meaning
off	–	10 Mbps connection
steady green light	–	100 Mbps connection
steady yellow light	–	1,000-Mbps connection
–	flashing green light	Activity
–	off	No connection/activity

- X3 = WAN port  
To connect to an ITSP, for example, using DSL (PPPOE or PPTP protocol). The WAN can be connected to the DSL modem either directly or via a router.
- X4 = LAN connection  
For linking into the LAN infrastructure of the customer, for connecting a WLAN Access Point, an additional LAN switch or the direct connection of an IP phone or PC client.
- X5 = Admin port  
For connecting a service PC to administer the communication system.

### Subboards

---

**NOTICE:** Place the mainboard on a flat surface before inserting a subboard. Otherwise you may damage the mainboard.

The spacing bolts supplied guarantee the correct positioning of a subboard, so you should always mount them.

---

The following optional subboards can be used depending on the application:

- OCAB (Open Core Application Booster)  
The UC Booster Card OCAB (Application Board) should be used whenever the functions of the UC Suite for Unified Communications and Collaboration are needed. The OCAB is mounted on the OCCL mainboard using two plug-in spacing bolts and two screw spacers.  
The electrical connection between OCCL and OCAB is established via the connection cable supplied with the UC Booster Card (OCCL = X8 <> OCAB = X4).
- OCCB (Open Core Channel Booster)  
If the number of DSPs provided on the central control board is insufficient, an OCCB subboard can be used. OCCB1 provides one additional DSP (digital signal processor), and OCCB3 provides three additional DSPs.  
The OCCB subboards have a PCI-E jack which is plugged into the edge connector X6.

## Boards

### Description of the Boards

---

**INFO:** At present, the use of one OCCB subboard has been approved.

The edge connector X7 is intended for future applications.

---

- **Announcement and Music Modules**  
The following modules are available:
  - **EXMR**  
The subboard enables the connection of an external music source and thus the provisioning of announcements and music on hold (MOH).
  - **MUSIC plugin module**  
The subboard provides music on hold (MOH).  
The announcement and music module is plugged into the socket terminal strips X9 and X10 on the OCCL.

### Reset Switch

The board includes a reset switch with the following functions.

**Table:** OCCL – Functions of the Reset Switch

Reset switch is pressed	Result	Red LED
< 5 s	The communication system performs a controlled restart (similar to pressing the Reset button on a PC). The communication system will be operational again after the startup.	on
> 5 s and < 10 s	A controlled shutdown of the communication system is performed.	off
> 10 s	A reload is initiated on the communication system. The communication system reverts to the initial (default) state following startup. All country and customer-specific settings are lost (system country code = Germany). Country- and customer-specific data backups can be reloaded once the basic settings have been configured.	on

Immediately after releasing the reset switch, the selected function (restart, shutdown or reload) is executed.

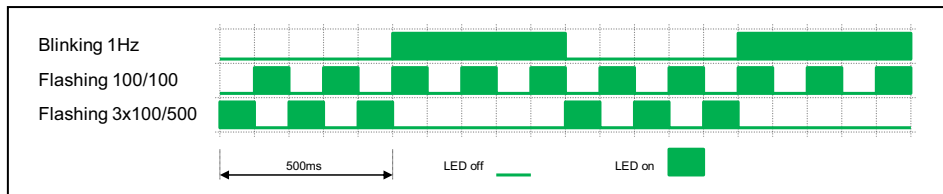
### LEDs

The board features two LEDs that indicate the operating states.

**Table:** OCCL – LED Statuses and their Meanings

Green LED	Red LED	Meaning
off	on	Default state after the communication system is connected to the power supply (< 1 s)
flickering 2500/250	flickering 250/2500	The SDHC card must not be inserted.
on	off	UBOOT (Universal Boot Loader) startup. The LED states do not change until the UBOOT startup has been completed.
on	flashing 1 Hz	Only if an FW update is available: UBOOT: FW update process is running. <b>The system must be disconnected from the mains.</b> After the startup is completed, a restart is automatically performed.
off	on	The UBOOT startup was stopped. A system error has occurred (e.g., the write protection of the SDHC card is enabled). The Linux startup is not possible.  The system error can be read via a console on a PC that is connected to the USB control interface.
off	off	The UBOOT startup has completed.
on	off	Linux startup
on	on	The Linux startup has completed. The system is starting.
on	flashing 1 Hz	Only if a USB flash drive with a SW update is detected: SW update via the USB flash drive during startup
on	flickering 100/100	Only if a USB flash drive with a SW update is detected: The USB flash drive is unmounted in Linux and should be removed while the LED is flickering (without OCAB: 10 s / with OCAB: a few minutes)  After the software update, a restart is automatically performed.
flickering 3x100/500	on	Feature Process Startup Procedure running.
flickering 3x100/500	off	LAN Device Handler Startup Procedure running.
flashing	off	Normal operating state (1 Hz)
flashing 1 Hz	flashing 1 Hz	Only if OCAB is inserted and the OCCx is in a normal operating state: OCAB has no IP connection to the OCCx.  The red LED goes out as soon as the OCAB has a connection to the OCCx.

Green LED	Red LED	Meaning	
flashing 1 Hz	on	< 5 s duration	The reset switch was pressed during normal operation. The assigned function (Restart/Shutdown/Reload) is executed as soon as the button is released and the Green LED stops flashing.
	off	> 5 s and < 10 s duration	
	on	> 10 s duration	
off	on	The system shutdown has been completed. The system must be disconnected from the power supply.  This status is shown after system shutdown. It must not be confused with the system error status <b>Green LED: off - Red LED: on</b> , which is shown during UBOOT startup, in order to indicate that "UBOOT startup was stopped".	
off	off	The shutdown of the communication has been completed or No power	



### Pin Assignments

**Table:** OCAB - Pin assignments of the X15, X16 and X17 RJ45 connectors (Ethernet interfaces), depending on the connection

Pin	10/100BaseT		1000BaseT	
	Signal	Description	Signal	Description
1	Tx +	Transmit +	Tx A +	Pair A: Transmit +
2	Tx -	Transmit -	Tx A -	Pair A: Transmit -
3	Rx +	Receive +	Tx B +	Pair B: Transmit +
4	-	Not used	Tx C +	Pair C: Transmit +
5	-	Not used	Tx C -	Pair C: Transmit -
6	Rx -	Receive -	Tx B -	Pair B: Transmit -
7	-	Not used	Tx D +	Pair D: Transmit +
8	-	Not used	Tx D -	Pair D: Transmit -

### 3.2.19 OCCM

OCCM (Open Core Controller Medium) is the central control board (mainboard) of the OpenScape Business X3W and OpenScape Business X5W communication systems.

The SD card slot contains the SDHC (Secure Digital High Capacity) card with the current software of the communication system.

---

**NOTICE:** The SDHC card must never be removed or inserted while the communication system is up and running. Otherwise, there may be damage to the file system and thus result in the failure of the communication system.

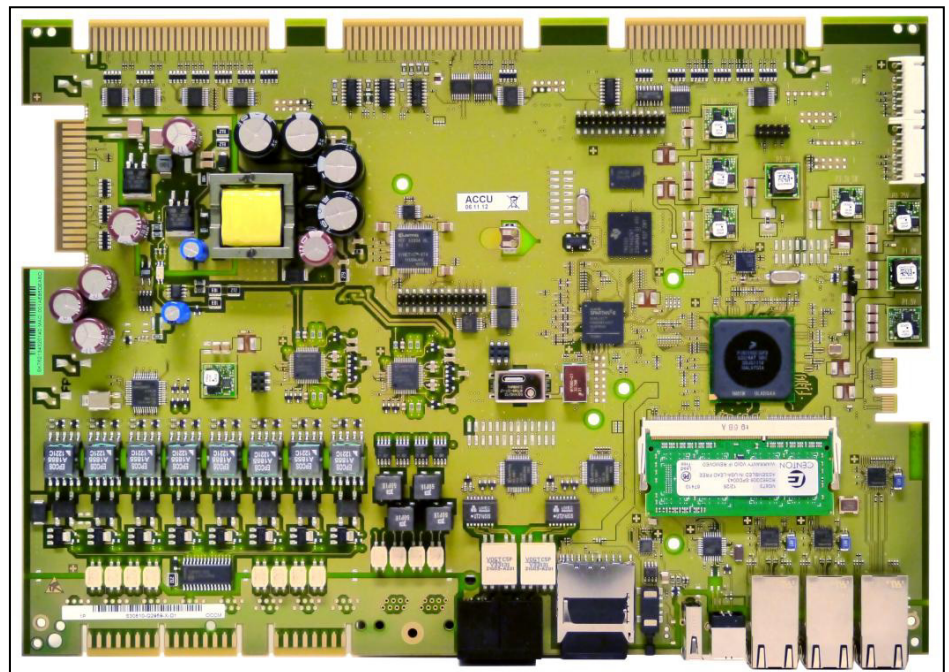
---

### Board Variants and their Use

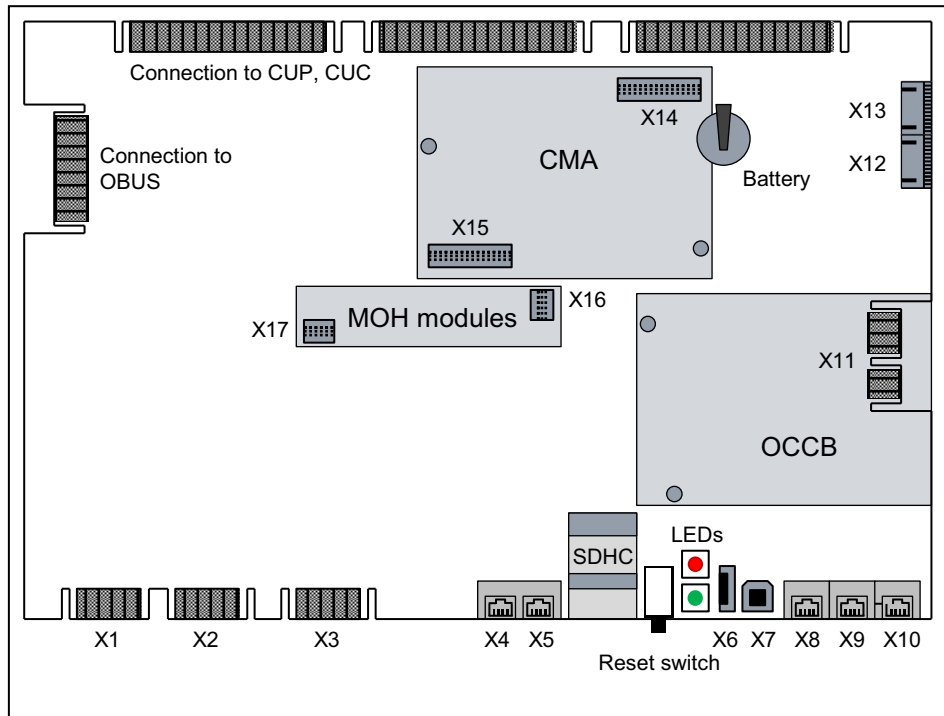
Board	Part Number	Used in		Maximum number
		Communication system	Country	
OCCM	S30810-K2959-X	OpenScape Business X3W OpenScape Business X5W	ROW	1

### Figure

Figure: OCCM



**Figure:** OCCM - Connections



**Battery**

There is a battery on the mainboard that is used to buffer the date and time.

---

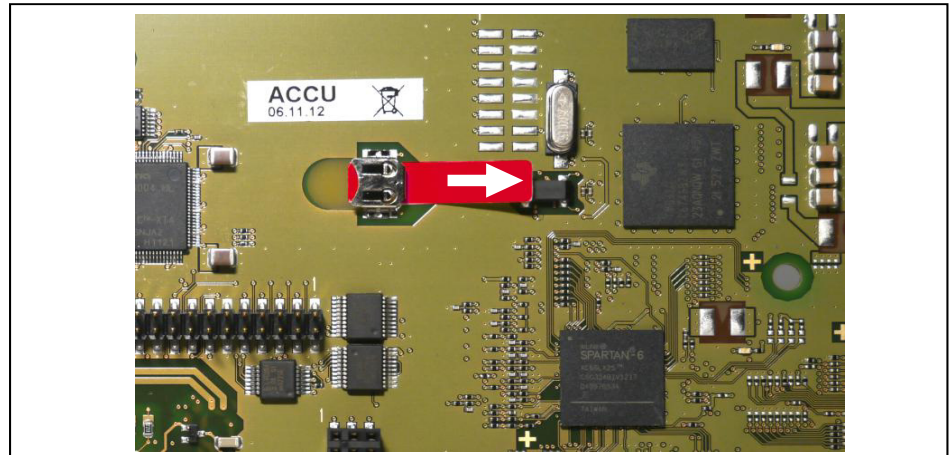
**NOTICE:** Before starting up the communication system, the battery must be activated. To do this, the protective film shown in the following figure must be removed.

In order to not loosen the battery, the protective film must be removed only at the closed side of the battery holder (indicated by arrow in the following figure).

---



**Figure:** OCCM - Battery with Protective Film



### Temperature Monitoring

The temperature of the system is monitored. At temperatures higher than 61 degrees Celsius, a notification can be sent to up to three system telephones with a display, by e-mail or through signaling via an SNMP trap. Entries are made in the event log and event viewer (client trace) only if the system exceeds or falls below the critical temperatures. Logging occurs in the message log so long as the value is less than or equal to 58° Celsius.

At temperatures above 66 °C, the message "Alarm: critical system temperature!" is displayed on the home page of the OpenScape Business Assistant (WBM). Any existing SLAV/SLAD boards are switched off. Then, the system must be shut down and disconnected from the power supply. After checking the system and any existing SLAV/SLAD boards, the system can be reconnected to the power supply and restarted. The alarm is thus cleared, and the SLAV/SLAD boards are put back into operation.

### Connectors

---

**NOTICE:** Fire hazard due to surge voltage

Only for the  $U_{P0/E}$ , a/b and  $S_0$  interfaces used for the station connection: In the case of line lengths exceeding 500 m and where the lines exit the building, the OCCM board must be protected by external lightning protection.

Lightning protection of this kind is known as additional primary protection. The additional primary protection is guaranteed by installing ÜSAGs (surge arresters, gas filled) in the main distribution frame, the patch panel or at the entry point of the pipe in the building. A gas-filled surge arrester with 230 V nominal voltage is switched to ground from each wire that is to be protected.

---

- X1, X2 = 8  $U_{P0/E}$  interfaces (edge connectors)  
The following can be connected

## Boards

### Description of the Boards

- U<sub>P0/E</sub> phones (e.g., OpenStage T) and
- DECT base stations for DECT Light (integrated cordless solution).  
To connect the base stations, the U<sub>P0/E</sub> interfaces 2 through 8 must be used.  
For information on the installation and connection of DECT base stations, see *Integrated Cordless Solution*.
- X3 = 4 a/b interfaces (edge connectors)  
Analog phones and devices (fax, modem, etc.) can be connected.  
The interfaces supply a ring voltage of approx. 65 V<sub>eff</sub>.  
Calling name identification presentation (CLIP) is supported.  
The connection of external extensions is not possible.
- X4, X5 = 2 S<sub>0</sub> interfaces (RJ45 jacks)  
The S<sub>0</sub> interfaces can be used for the ISDN trunk connection (ISDN trunk) or the ISDN station connections (ISDN phones, Fax Group 4, etc.).  
The RJ45 jacks are wired for the direct connection of ISDN trunk lines. A twisted ISDN patch cable must be used for the station connection or the Receive and Transmit wires of the ISDN cables must be reversed.  
The ISDN phones to be connected must have a separate power source, e.g., via a power adapter. It is not possible to obtain power via the S<sub>0</sub> ports of the central control board.
- X6 = USB control interface (USB 1.1)  
To connect a PC for service and diagnostic purposes.
- X7 = USB server Interface (USB 2.0)  
For connecting an external hard disk or USB stick for backups and software upgrades.
- X8, X9, X10 = 3 Ethernet (10/100/1000 BaseT) ports (RJ45 jacks)  
Two LEDs indicate the current status of each Ethernet interface.

**Table:** OCCM – LEDs for Indicating the Ethernet Interface Status

Left LED (Speed)	Right LED (Link/Activity)	Meaning
off	–	10 Mbps connection
steady green light	–	100 Mbps connection
steady yellow light	–	1,000-Mbps connection
–	flashing green light	Activity
–	off	No connection/activity

- X8 = WAN port  
To connect to an ITSP, for example, using DSL (PPPOE or PPTP protocol). The WAN can be connected to the DSL modem either directly or via a router.
- X9 = LAN connection  
For linking into the LAN infrastructure of the customer, for connecting a WLAN Access Point, an additional LAN switch or the direct connection of an IP phone or PC client.

- X10 = Admin port  
For connecting a service PC to administer the communication system.
- X13 = Plug contact for the OCAB (Open Core Application Booster) connection cable  
The UC Booster Card OCAB (Application Board) must be used if, for example, the functions of the UC Suite for unified communications and collaboration or the Open Directory Service are required. In addition, OCAB is a prerequisite for the connection of external applications to the CSTA interface. See the *OCAB (UC Booster Card)* board description.

### Subboards

---

**NOTICE:** Place the mainboard on a flat surface before inserting a subboard. Otherwise you may damage the mainboard.

The spacing bolts supplied guarantee the correct positioning of a subboard, so you should always mount them.

---

The following optional subboards can be used depending on the application:

- CMA (ADPCM clock module) or CMAe (Clock Module with ADPCM enhanced)  
CMA and CMAe are used in combination with DECT Light (integrated cordless solution). The subboard provides the functions for ADPCM conversion and echo cancellation (16 channels for CMA and 48 channels for CMAe). Up to four calls can be conducted per base station. Up to seven base stations can be connected to the U<sub>P0/E</sub> interfaces of the central control board. The subboard is plugged into the X14 and X15 connector strips on the OCCM. If no CMA is installed, a maximum of two calls can be conducted per base station. In this case, ADPCM conversion and echo cancellation are performed directly by the base station.
- OCCB (Open Core Channel Booster)  
If the number of DSPs provided on the central control board is insufficient, an OCCB subboard can be used. OCCB1 provides one additional DSP (digital signal processor), and OCCB3 provides three additional DSPs. The OCCB subboards have a PCI-E jack which is plugged into the edge connector X11.
- Announcement and Music Modules  
The following modules are available:
  - EXMR  
The subboard enables the connection of an external music source and thus the provisioning of announcements and music on hold (MOH).
  - MUSIC plugin module  
The subboard provides music on hold (MOH).The announcement and music module is plugged into the socket terminal strips X16 and X17 on the OCCM.

### Reset Switch

The board includes a reset switch with the following functions.

**Table:** OCCM – Functions of the Reset Switch

Reset switch is pressed	Result	Red LED
< 5 s	The communication system performs a controlled restart (similar to pressing the Reset button on a PC). The communication system will be operational again after the startup.	on
> 5 s and < 10 s	A controlled shutdown of the communication system is performed.	off
> 10 s	A reload is initiated on the communication system. The communication system reverts to the initial (default) state following startup. All country and customer-specific settings are lost (system country code = Germany). Country- and customer-specific data backups can be reloaded once the basic settings have been configured.	on

Immediately after releasing the reset switch, the selected function (restart, shutdown or reload) is executed.

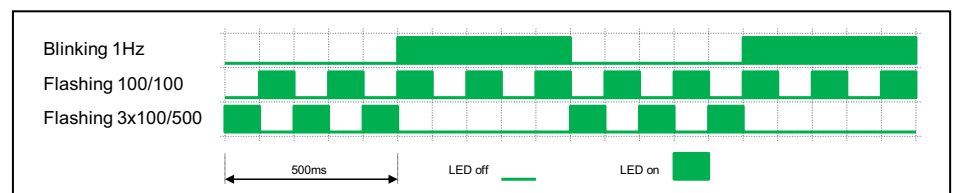
**LEDs**

The board features two LEDs that indicate the operating states.

**Table:** OCCM – LED Statuses and their Meanings

Green LED	Red LED	Meaning
off	on	Default state after the communication system is connected to the power supply (< 1 s)
flickering 2500/250	flickering 250/2500	The SDHC card must not be inserted.
on	off	UBOOT (Universal Boot Loader) startup. The LED states do not change until the UBOOT startup has been completed.
on	flashing 1 Hz	Only if an FW update is available: UBOOT: FW update process is running. <b>The system must be disconnected from the mains.</b> After the startup is completed, a restart is automatically performed.
off	on	The UBOOT startup was stopped. A system error has occurred (e.g., the write protection of the SDHC card is enabled). The Linux startup is not possible.  The system error can be read via a console on a PC that is connected to the USB control interface.
off	off	The UBOOT startup has completed.
on	off	Linux startup
on	on	The Linux startup has completed. The system is starting.

Green LED	Red LED	Meaning	
on	flashing 1 Hz	Only if a USB flash drive with a SW update is detected: SW update via the USB flash drive during startup	
on	flickering 100/100	Only if a USB flash drive with a SW update is detected: The USB flash drive is unmounted in Linux and should be removed while the LED is flickering (without OCAB: 10 s / with OCAB: a few minutes) After the software update, a restart is automatically performed.	
flickering 3x100/500	on	Feature Process Startup Procedure running.	
flickering 3x100/500	off	LAN Device Handler Startup Procedure running.	
flashing	off	Normal operating state (1 Hz).	
flashing 1 Hz	flashing 1 Hz	Only if OCAB is inserted and the OCCx is in a normal operating state: OCAB has no IP connection to the OCCx. The red LED goes out as soon as the OCAB has a connection to the OCCx.	
flashing 1 Hz	on	< 5 s duration	The reset switch was pressed during normal operation. The assigned function (Restart/Shutdown/Reload) is executed as soon as the button is released and the Green LED stops flashing.
	off	> 5 s and < 10 s duration	
	on	> 10 s duration	
off	on	The system shutdown has been completed. The system must be disconnected from the power supply.  This status is shown after system shutdown. It must not be confused with the system error status <b>Green LED: off - Red LED: on</b> , which is shown during UBOOT startup, in order to indicate that "UBOOT startup was stopped".	
off	off	The shutdown of the communication has been completed or No power	



**Pin Assignments**

**Table:** OCCM - Pin Assignments of the X1 and X2 Edge Connectors (U<sub>P0/E</sub> Interfaces)

X1			X2		
Pin	Signal	Description	Pin	Signal	Description
1	1b	U <sub>P0/E</sub> interface 1	1	5b	U <sub>P0/E</sub> interface 5
2	1a		2	5a	
3	2b	U <sub>P0/E</sub> interface 2	3	6b	U <sub>P0/E</sub> interface 6
4	2a		4	6a	
5	3b	U <sub>P0/E</sub> interface 3	5	7b	U <sub>P0/E</sub> interface 7
6	3a		6	7a	
7	4b	U <sub>P0/E</sub> interface 4	7	8b	U <sub>P0/E</sub> interface 8
8	4a		8	8a	

**Table:** OCCM - Pin Assignments of the X3 Edge Connector (a/b Interfaces)

Pin	Signal	Description
1	1a	a/b interface 1
2	1b	
3	2a	a/b interface 2
4	2b	
5	3a	a/b interface 3
6	3b	
7	4a	a/b interface 4
8	4b	

**Table:** OCCM - Pin Assignments of the RJ45 Jacks X4 and X5 (S<sub>0</sub> Interfaces)

X4			X5		
Pin	Signal	Description	Pin	Signal	Description
1	–	Not used	1	–	Not used
2	–	Not used	2	–	Not used
3	Ta	Transmit +	3	Ta	Transmit +
4	Ra	Receive +	4	Ra	Receive +
5	Rb	Receive –	5	Rb	Receive –
6	Tb	Transmit –	6	Tb	Transmit –
7	–	Not used	7	–	Not used
8	–	Not used	8	–	Not used

**Table:** OCCM - Pin assignments of the X8, X9 and X10 RJ45 connectors (Ethernet interfaces), depending on the connection

Pin	10/100BaseT		1000BaseT	
	Signal	Description	Signal	Description
1	Tx +	Transmit +	Tx A +	Pair A: Transmit +
2	Tx –	Transmit –	Tx A –	Pair A: Transmit -
3	Rx +	Receive +	Tx B +	Pair B: Transmit +
4	–	Not used	Tx C +	Pair C: Transmit +
5	–	Not used	Tx C –	Pair C: Transmit -
6	Rx –	Receive –	Tx B –	Pair B: Transmit -
7	–	Not used	Tx D +	Pair D: Transmit +
8	–	Not used	Tx D –	Pair D: Transmit -

### 3.2.20 OCCMR

OCCMR (Open Core Controller Medium) is the central control board (mainboard) of the OpenScape Business X3R and OpenScape Business X5R communication systems.

The SD card slot contains the SDHC (Secure Digital High Capacity) card with the current software of the communication system.

---

**NOTICE:** The SDHC card must never be removed or inserted while the communication system is up and running. Otherwise, there may be damage to the file system and thus result in the failure of the communication system.

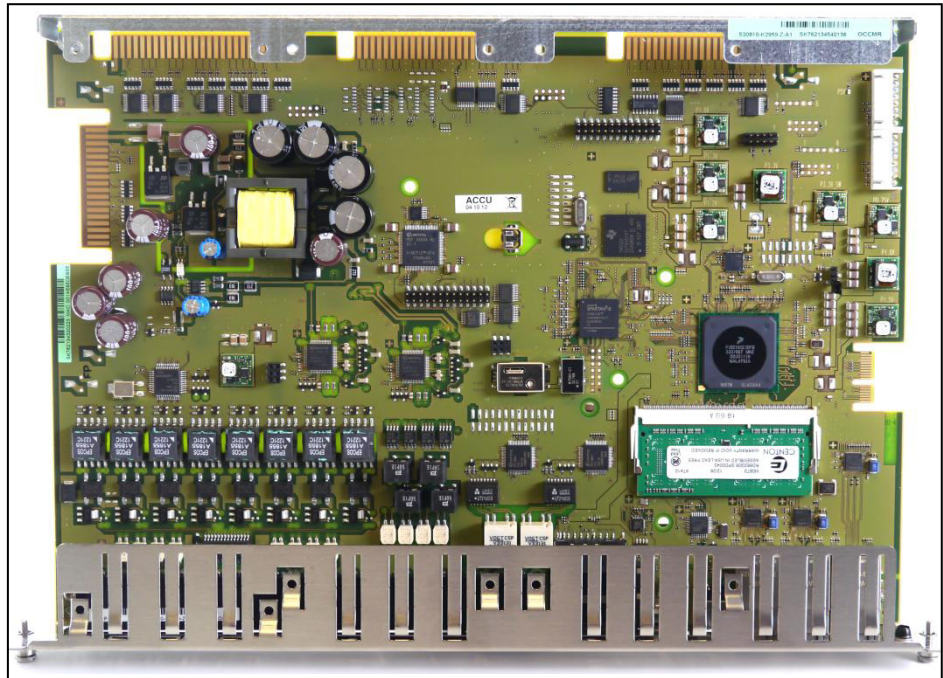
---

#### Board Variants and their Use

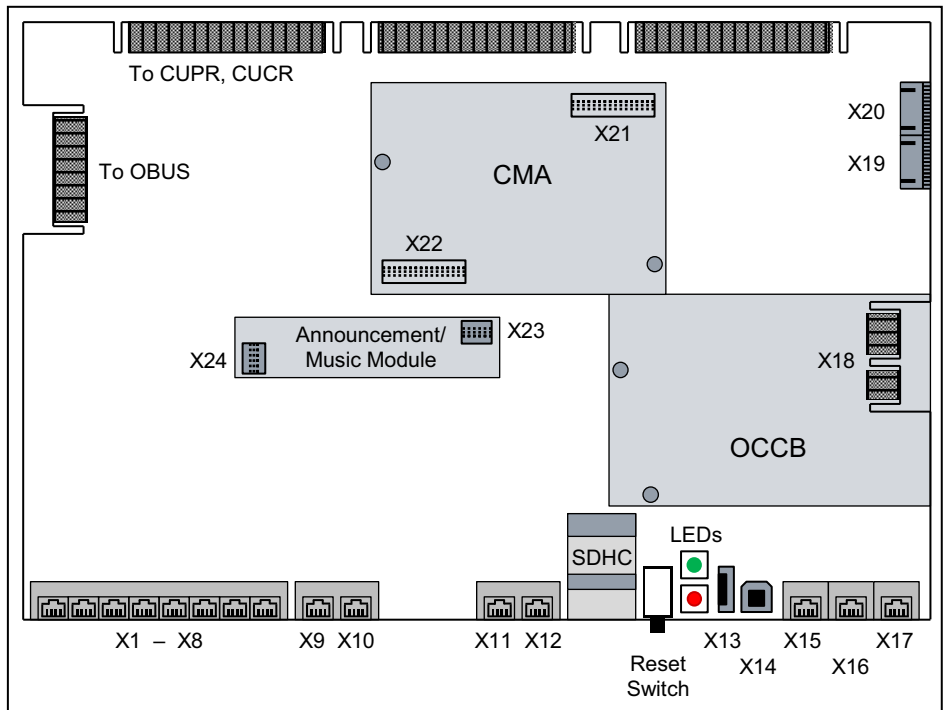
Board	Part Number	Used in		Maximum number
		Communication system	Country	
OCCMR	S30810-K2959-Z	OpenScape Business X3R OpenScape Business X5R	ROW	1

**Figure**

**Figure:** OCCMR



**Figure:** OCCMR - Connections



**Battery**

There is a battery on the mainboard that is used to buffer the date and time.



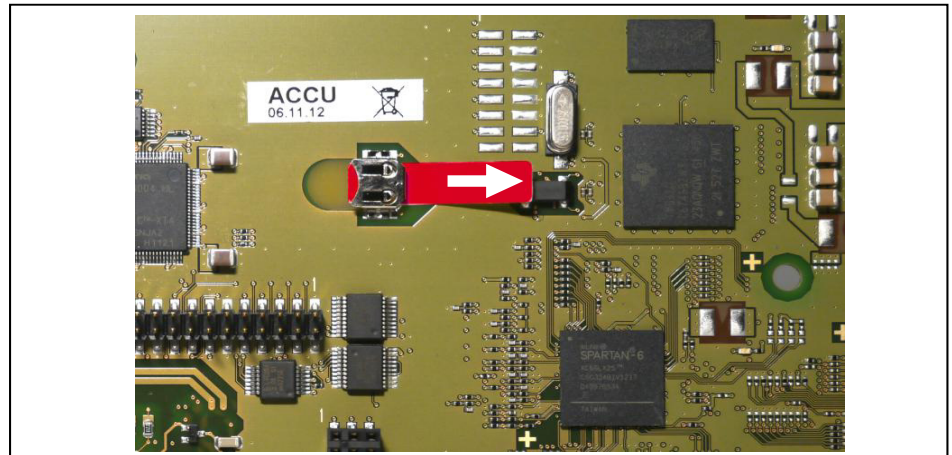
---

**NOTICE:** Before starting up the communication system, the battery must be activated. To do this, the protective film shown in the following figure must be removed.

In order to not loosen the battery, the protective film must be removed only at the closed side of the battery holder (indicated by arrow in the following figure).

---

**Figure:** OCCMR - Battery with Protective Film



### Temperature Monitoring

The temperature of the system is monitored. At temperatures higher than 61 degrees Celsius, a notification can be sent to up to three system telephones with a display, by e-mail or through signaling via an SNMP trap. Entries are made in the event log and event viewer (client trace) only if the system exceeds or falls below the critical temperatures. Logging occurs in the message log so long as the value is less than or equal to 58° Celsius.

At temperatures above 66 °C, the message "Alarm: critical system temperature!" is displayed on the home page of the OpenScape Business Assistant (WBM). Any existing SLAV/SLAD boards are switched off. Then, the system must be shut down and disconnected from the power supply. After checking the system and any existing SLAV/SLAD boards, the system can be reconnected to the power supply and restarted. The alarm is thus cleared, and the SLAV/SLAD boards are put back into operation.

### Connectors

---

**NOTICE:** Fire hazard due to surge voltage

Only for the  $U_{P0/E}$ , a/b and  $S_0$  interfaces used for the station connection: In the case of line lengths exceeding 500 m and where the lines exit the building, the OCCMR board must be protected by external lightning protection.

Lightning protection of this kind is known as additional primary protection. The additional primary protection is guaranteed by

## Boards

### Description of the Boards

installing ÜSAGs (surge arresters, gas filled) in the main distribution frame, the patch panel or at the entry point of the pipe in the building. A gas-filled surge arrester with 230 V nominal voltage is switched to ground from each wire that is to be protected.

---

- X1-X8 = 8  $U_{P0/E}$  interfaces (edge connectors)

The following can be connected

- $U_{P0/E}$  phones (e.g., OpenStage T) and
- DECT base stations for DECT Light (integrated cordless solution).  
To connect the base stations, the  $U_{P0/E}$  interfaces 2 through 8 must be used.

For information on the installation and connection of DECT base stations, see .

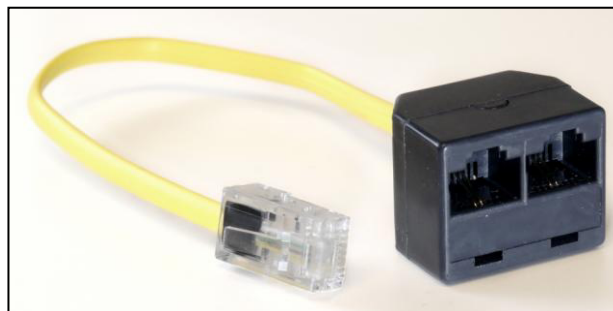
- X9, X10 = 4 a/b interfaces (RJ45 jacks)

Analog phones and devices (fax, modem, etc.) can be connected.

The following must be noted when connecting the phones and devices:

- Direct connection: using a standard connection cable, one analog phone or device each can be connected directly to the X9 and X10 RJ45 jacks.
- Connection via a/b interface adapter (with part number C39195-Z7230-A1) : If more than two analog phones or devices need to be connected, the a/b interface adapter is required. Inserting an adapter provides two a/b interfaces per RJ45 jack.

**Figure:** a/b Interface Adapter



The interfaces supply a ring voltage of approx. 65  $V_{eff}$ .

Calling name identification presentation (CLIP) is supported.

The connection of external extensions is not possible.

- X11, X12 = 2  $S_0$  interfaces (RJ45 jacks)

The  $S_0$  interfaces can be used for the ISDN trunk connection (ISDN trunk) or the ISDN station connections (ISDN phones, Fax Group 4, etc.).

The RJ45 jacks are wired for the direct connection of ISDN trunk lines. A twisted ISDN patch cable must be used for the station connection or the Receive and Transmit wires of the ISDN cables must be reversed.

The ISDN phones to be connected must have a separate power source, e.g., via a power adapter. It is not possible to obtain power via the  $S_0$  ports of the central control board.

- X13 = USB control interface (USB 1.1)  
To connect a PC for service and diagnostic purposes.
- X14 = USB server interface (USB 2.0)  
For connecting an external hard disk or USB stick for backups and software upgrades.
- X15, X16, X17 = 3 Ethernet (10/100/1000 BaseT) ports (RJ45 jacks)  
Two LEDs indicate the current status of each Ethernet interface.

**Table:** OCCMR – LEDs for Indicating the Ethernet Interface Status

Left LED (Speed)	Right LED (Link/Activity)	Meaning
off	–	10 Mbps connection
steady green light	–	100 Mbps connection
steady yellow light	–	1,000-Mbps connection
–	flashing green light	Activity
–	off	No connection/activity

- X15 = WAN port  
To connect to an ITSP, for example, using DSL (PPPOE or PPTP protocol). The WAN can be connected to the DSL modem either directly or via a router.
- X16 = LAN connection  
For linking into the LAN infrastructure of the customer, for connecting a WLAN Access Point, an additional LAN switch or the direct connection of an IP phone or PC client.
- X17 = Admin port  
For connecting a service PC to administer the communication system.
- X20 = Plug contact for the OCAB (Open Core Application Booster) connection cable  
The UC Booster Card OCAB (Application Board) must be used if, for example, the functions of the UC Suite for unified communications and collaboration or the Open Directory Service are required. In addition, OCAB is a prerequisite for the connection of external applications to the CSTA interface (see the board description ).

### Subboards

---

**NOTICE:** Place the mainboard on a flat surface before inserting a subboard. Otherwise you may damage the mainboard.

The spacing bolts supplied guarantee the correct positioning of a subboard, so you should always mount them.

---

The following optional subboards can be used depending on the application:

## Boards

### Description of the Boards

- **CMA (ADPCM clock module) or CMAe (Clock Module with ADPCM enhanced)**  
CMA and CMAe are used in combination with DECT Light (integrated cordless solution). The subboard provides the functions for ADPCM conversion and echo cancellation (16 channels for CMA and 48 channels for CMAe). Up to four calls can be conducted per base station. Up to seven base stations can be connected to the U<sub>P0/E</sub> interfaces of the central control board. The subboard is plugged into the X21 and X22 connector strips. If no CMA is installed, a maximum of two calls can be conducted per base station. In this case, ADPCM conversion and echo cancellation are performed directly by the base station.
- **OCCB (Open Core Channel Booster)**  
If the number of DSPs provided on the central control board is insufficient, an OCCB subboard can be used. OCCB1 provides one additional DSP (digital signal processor), and OCCB3 provides three additional DSPs. The OCCB subboards have a PCI-E jack which is plugged into the edge connector X18.
- **Announcement and Music Modules**  
The following modules are available:
  - **EXMR**  
The subboard enables the connection of an external music source and thus the provisioning of announcements and music on hold (MOH).
  - **MUSIC plugin module**  
The subboard provides music on hold (MOH).  
The announcement and music module is plugged into the socket terminal strips X23 and X24.

### Reset Switch

The board includes a reset switch with the following functions.

**Table:** OCCMR – Functions of the Reset Switch

Reset switch is pressed	Result	Red LED
< 5 s	The communication system performs a controlled restart (similar to pressing the Reset button on a PC). The communication system will be operational again after the startup.	on
> 5 s and < 10 s	A controlled shutdown of the communication system is performed.	off
> 10 s	A reload is initiated on the communication system. The communication system reverts to the initial (default) state following startup. All country and customer-specific settings are lost (system country code = Germany). Country- and customer-specific data backups can be reloaded once the basic settings have been configured.	on

Immediately after releasing the reset switch, the selected function (restart, shutdown or reload) is executed.

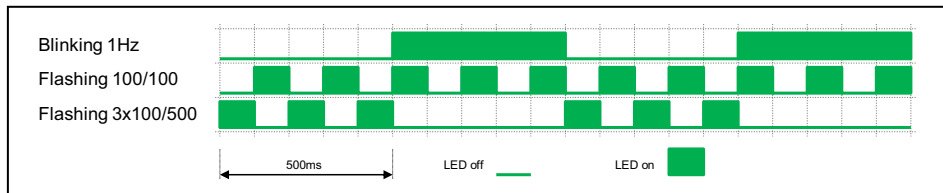
### LEDs

The board features two LEDs that indicate the operating states.

**Table:** OCCMR – LED Statuses and their Meanings

Green LED	Red LED	Meaning
off	on	Default state after the communication system is connected to the power supply (< 1 s)
flickering 2500/250	flickering 250/2500	The SDHC card must not be inserted.
on	off	UBOOT (Universal Boot Loader) startup. The LED states do not change until the UBOOT startup has been completed.
on	flashing 1 Hz	Only if an FW update is available: UBOOT: FW update process is running. <b>The system must be disconnected from the mains.</b> After the startup is completed, a restart is automatically performed.
off	on	The UBOOT startup was stopped. A system error has occurred (e.g., the write protection of the SDHC card is enabled). The Linux startup is not possible.  The system error can be read via a console on a PC that is connected to the USB control interface.
off	off	The UBOOT startup has completed.
on	off	Linux startup
on	on	The Linux startup has completed. The system is starting.
on	flashing 1 Hz	Only if a USB flash drive with a SW update is detected: SW update via the USB flash drive during startup
on	flickering 100/100	Only if a USB flash drive with a SW update is detected: The USB flash drive is unmounted in Linux and should be removed while the LED is flickering (without OCAB: 10 s / with OCAB: a few minutes)  After the software update, a restart is automatically performed.
flickering 3x100/500	on	Feature Process Startup Procedure running.
flickering 3x100/500	off	LAN Device Handler Startup Procedure running.
flashing	off	Normal operating state (1 Hz)

Green LED	Red LED	Meaning	
flashing 1 Hz	flashing 1 Hz	Only if OCAB is inserted and the OCCx is in a normal operating state: OCAB has no IP connection to the OCCx. The red LED goes out as soon as the OCAB has a connection to the OCCx.	
flashing 1 Hz	on	< 5 s duration	The reset switch was pressed during normal operation. The assigned function (Restart/Shutdown/Reload) is executed as soon as the button is released and the Green LED stops flashing.
	off	> 5 s and < 10 s duration	
	on	> 10 s duration	
off	on	The system shutdown has been completed. The system must be disconnected from the power supply. This status is shown after system shutdown. It must not be confused with the system error status <b>Green LED: off - Red LED: on</b> , which is shown during UBOOT startup, in order to indicate that "UBOOT startup was stopped".	
off	off	The shutdown of the communication has been completed or No power	



**Pin Assignments**

**Table:** OCCMR - Pin Assignments of the RJ45 Jacks X1 to X8 (U<sub>P0/E</sub> Interfaces)

Pin	Signal	Description
1	–	Not used
2	–	Not used
3	–	Not used
4	a	U <sub>P0/E</sub> interface
5	b	
6	–	Not used
7	–	Not used
8	–	Not used

**Table:** OCCMR - Pin Assignments of the RJ45 Jacks X9 and X10 (a/b Interfaces)

X9			X10		
Pin	Signal	Description	Pin	Signal	Description
1	–	Not used	1	–	Not used
2	–	Not used	2	–	Not used
3	3b	a/b interface 3	3	4b	a/b interface 4
4	1b	a/b interface 1	4	2b	a/b interface 2
5	1a	a/b interface 1	5	2a	a/b interface 2
6	3a	a/b interface 3	6	4a	a/b interface 4
7	–	Not used	7	–	Not used
8	–	Not used	8	–	Not used

**Table:** OCCMR - Pin Assignments of the RJ45 Jacks X11 and X12 (S<sub>0</sub> Interfaces)

X11			X12		
Pin	Signal	Description	Pin	Signal	Description
1	–	Not used	1	–	Not used
2	–	Not used	2	–	Not used
3	Ta	Transmit +	3	Ta	Transmit +
4	Ra	Receive +	4	Ra	Receive +
5	Rb	Receive –	5	Rb	Receive –
6	Tb	Transmit –	6	Tb	Transmit –
7	–	Not used	7	–	Not used
8	–	Not used	8	–	Not used

**Table:** OCAB - Pin assignments of the X15, X16 and X17 RJ45 jacks (Ethernet interfaces), depending on the connection

Pin	10/100BaseT		1000BaseT	
	Signal	Description	Signal	Description
1	Tx +	Transmit +	Tx A +	Pair A: Transmit +
2	Tx –	Transmit –	Tx A –	Pair A: Transmit -
3	Rx +	Receive +	Tx B +	Pair B: Transmit +
4	–	Not used	Tx C +	Pair C: Transmit +
5	–	Not used	Tx C –	Pair C: Transmit -
6	Rx –	Receive –	Tx B –	Pair B: Transmit -
7	–	Not used	Tx D +	Pair D: Transmit +
8	–	Not used	Tx D –	Pair D: Transmit -

## Boards

Description of the Boards

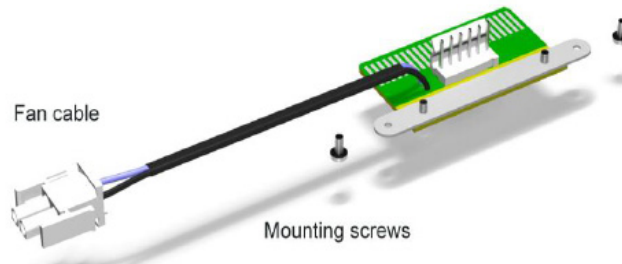
### 3.2.21 OCPSA

The OCPSA adapter (Open Core Power Supply Adapter) enables the connection between OCPSM power supply unit and CUC, CUCR, CUP, CUPR backplanes.

#### Board Variants and their Use

Board	Part Number	Used in		Maximum number
		Communication system	Country	
OCPSA	S30807-Q6958-X	OpenScape Business X3R OpenScape Business X3W OpenScape Business X5R OpenScape Business X5W	ROW	1

The adapter can be connected to a fan-kit when applicable.



### 3.2.22 OCPSM

OCPSM (Open Core Power Supply Medium) is the central power supply of the OpenScape Business X3W, OpenScape Business X3R, OpenScape Business X5W and OpenScape Business X5R communication systems. It is the successor of UPSC-D/DR.

The compatibilities of the power supply units (PSU) are described in the following tables:



**Table:** Compatibility table for UPSC-D/UPSC-DR/OCPSM

	X3W	X3R	X5W	X5R	X3W,X3R, X5W, X5R inc. SLADx	Powerbox for additional phone power requirement	Powerbox for non interruptibility of main power
<b>UPSC-D</b>	x	-	x	-	x	x	x
<b>UPSC-DR</b>	-	x	-	x	x	x	x
<b>OCPSM</b>	x (inc. Metal cover)	x (w/o Metal cover)	x (inc. Metal cover)	x (w/o Metal cover)	Does not support external ringing for SLAD cards	OCPSM cannot connect to Powerbox as it is not needed. OCPSM is able to supply every HW configuration.	OCPSM cannot connect to Powerbox Uninterruptibility is not available and a UPS is needed.

**Table:** Compatibility table for PSUs and backplanes

	CUC/CUP	CUCR/CUPR	CUX3W/CUX3R/CUX5W/CUX5R
<b>UPSC-D</b>	x	-	-
<b>UPSC-DR</b>	-	x	-
<b>OCPSM</b>	x (inc. OCPSA)	x (inc. OCPSA)	x

**Table:**

	CUC	CUX5W
<b>UPSC-D</b>	C39165-A7021-B310	-
<b>OCPSM</b>	-	C39165-A7021-B320
<b>OCPSM+OCPSA</b>	C39165-A7021-B310	-

OCPSM is in two mechanically different system environments:

- OCPSM assembled in OpenScape Business X3W and X5W:
  - Built in power supply for wall mounted cabinets
  - Vertically mounted inside cabinet and convection cooled
  - Protective cover mounted above OCPSM
- OCPSM assembled in OpenScape Business X3R and X5R:
  - Built in power supply for 19" rack cabinets
  - Horizontally mounted into the cabinet with forced ventilation by fan in system housing

## Boards

### Description of the Boards

OCPSM supports power supply functions. No other components are required if it is operated as a power supply. To maintain short-term battery emergency operation after a power failure, that is, to use uninterruptible power supply functions, you must connect a UPS device.

OCPSM is only released for permanent operation in an AC grid.

### Board Variants and their Use

Board	Part Number	Used in		Maximum number
		Communication system	Country	
OCPSM	S30122-H7757-X	OpenScape Business X3W OpenScape Business X3R OpenScape Business X5W OpenScape Business X5R	ROW	1

### Technical Data

- Nominal voltage range: 100 VAC - 240 VAC
- Nominal frequency: 47 Hz - 63 Hz
- Output voltages: +5 VDC, -48 VDC
- Power consumption: 223.2 W

### Figure



---

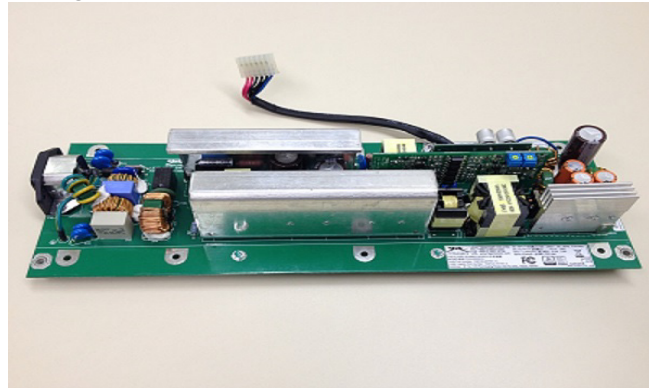
#### WARNING

#### Risk of electric shock through contact with live wires

The screw performs the ground connection between OCPSM and the housing of the communication system and must always be installed.

---

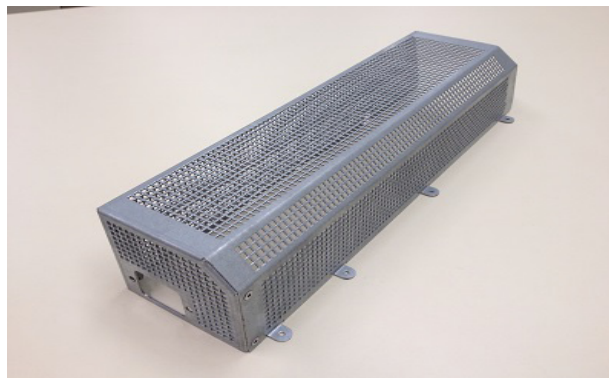
**Figure:** OCPSM



**OCPSM cover**

The OCPSM shall have a cover which gives the following functions:

- Protection of service personal against touching of hazardous voltages during installation / maintenance
- Bottom, in wall mount position, with fire protection - grid



**Required mechanical parts**

- two feet with M4 screw hole
- 10 holes for M3x6 screws, self tapping, on its both sides for fixation of the metal cover directly to the PCB, screw direction from bottom to to
- two holes to connect the adaptor for legacy systems

The output is provided through a wired standard connection with a 6 vias cable finished by a 6 vias female connector molex.

**Pin configuration**

**Table:** Output connection

Pin	Name
1	-48 V
2	GND
3	GND

## Boards

### Description of the Boards

Pin	Name
4	GND
5	+5.1 V
6	+5.1 V



#### WARNING

##### Risk of electric shock through contact with live wires

The OpenScape Business X3W, OpenScape Business X3R, OpenScape Business X5W and OpenScape Business X5R communication systems must be switched off/on by pulling/reconnecting the power plug.

Disconnect all the communication system's power plugs and make sure that the communication system is not supplied by another power source (uninterrupted power supply unit, for instance) if the scheduled maintenance work requires the communication system to be in a de-energized state.

### 3.2.22.1 How to Replace X3W/X5W PSU by OCPSM



#### DANGER

##### Risk of electric shock through contact with live wires

Disconnect all power supply circuits of the communication system before removing the board:

- Disconnect the battery voltage, supply voltage and line voltage at any connected board.
- Disconnect the line cords of any connected battery pack or any connected batteries.
- Disconnect all power plugs of the communication system.

It is necessary to use the kit OpenScape Business WALL PSU UPG (C39165-A7021-D7), in case of a replacement of the UPSC-D PSU: S30122-H5660-X300 or S30122-H5660-X301 from the OpenScape Business X3W/X5W, by the OCPSM PSU (S30122-H7757-X), when customers have systems with the following backplanes:

- S30777-Q751-X (CUP) for OSBIZ X3W UNIFY (S30777-U775-X501)
- S30777-Q750-X (CUC) for OSBIZ X5W UNIFY (S30777-U777-X701)

The kit OpenScape Business WALL PSU UPG (C39165-A7021-D7 ) OCPSM, metal cover, OCPSA adapter, the necessary screws and cable straps.



---

**WARNING**

**Some precautions should be taken when handling the new PSU (OCPSM PSU):**

- The OCPSM from the kit C39165-A7021-D7 comes with cover already assembled.
  - The PSU may contain plastic bag and/or protective foam for transport protection. It should be removed before the installation.
- 

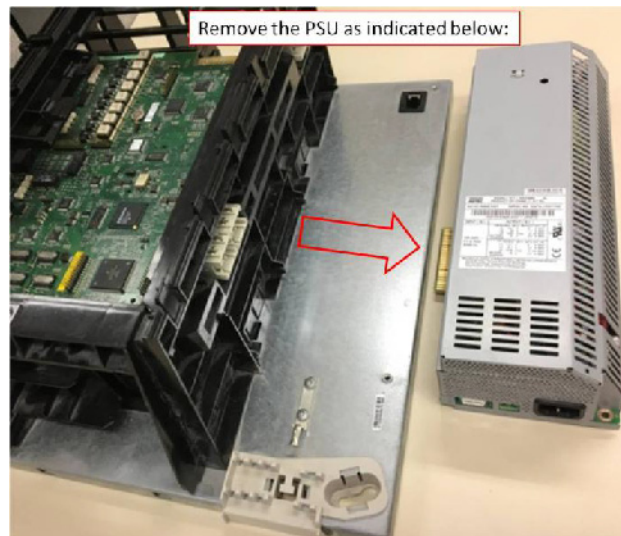
**Remarks:**

- Power Box/PB3000 is no longer be supported. If any backup power is need, the customer has to use a UPS.
- The SLAD modules (S30810-Q2956 and S30810-Q2957) are not supported.

**Step by Step**

- 1) Disconnect all power supply circuits of the communication system.
- 2) Make sure that the communication system is de-energized.
- 3) Remove the UPSC-D PSU from the system.

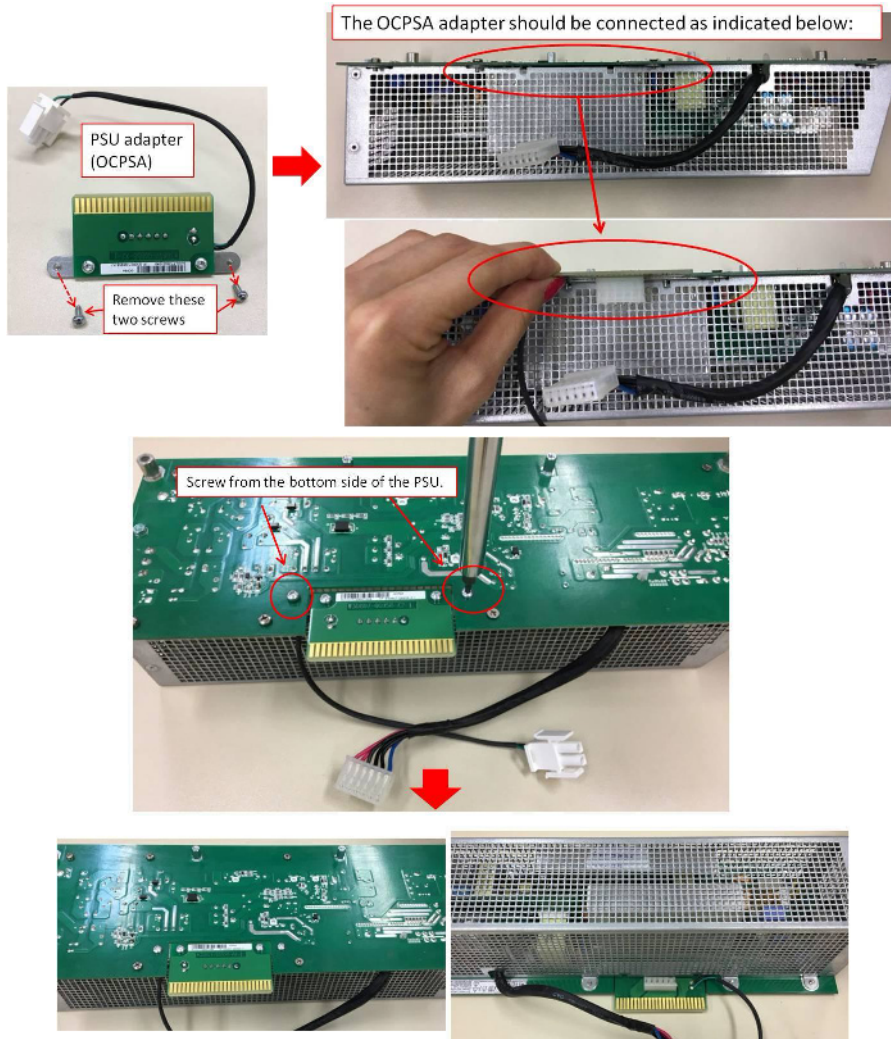
It is necessary to remove the screws and then removethe PSU as indicated:



- 4) Connect the OCPA adapter to the OCPSM PSU as indicated below:

## Boards

### Description of the Boards



5) Connect the PSU output cable into the OCPSA connector.



**INFO:** Take care with the polarity of the PSU output cable connector when connecting it to the OCPSA adapter, and also

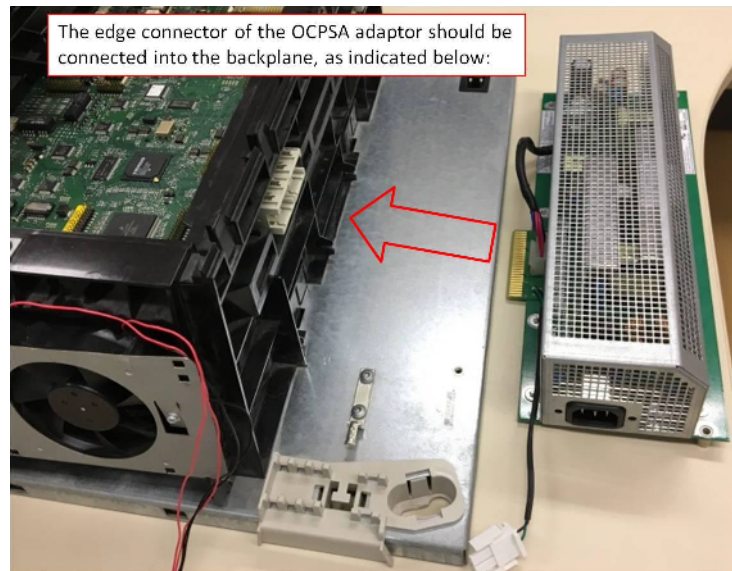


take care with the position of the pins (all pins must be connected).

---

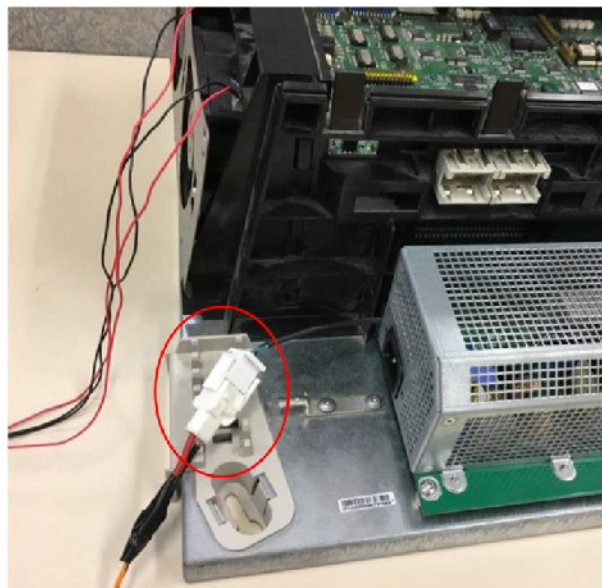
**6) Install the OCPSM PSU into the system.**

After attaching the OCPA adapter (S30807-Q6958-X) to the OCPSM PSU (S30122-H7757-X), with cover, install the OCPSM PSU into the system as indicated below and then screw the two screws.



**7) Connect the fankit C39165-A7021-B310 to the OCPA adapter.**

If the fankit C39165-A7021-B310 is used, it should be connected in the white connector of the OCPA adapter.



**8) Use the cable strap to attach the cable from the fankit into the system housing or into the fankit mechanical housing.**

## Boards

### Description of the Boards



- 9) If no fankit exists into the system, use the cable strap to attach the cable from the OCPSA, which will not be used in this case, to the system's housing.





### 3.2.22.2 How to Replace X3R/X5R PSU by OCPSM



---

#### **DANGER**

##### **Risk of electric shock through contact with live wires**

Disconnect all power supply circuits of the communication system before removing the board:

- Disconnect the battery voltage, supply voltage and line voltage at any connected board.
- Disconnect the line cords of any connected battery pack or any connected batteries.
- Disconnect all power plugs of the communication system.

---

It is necessary to use the kit OpenScape Business RACK PSU UPG (C39165-A7021-D6), in case of a replacement of the UPSC-DR PSU (S30122-H7373-X901) from the OpenScape Business X3R/X5R, by the OCPSM PSU, have systems with the following backplanes:

- S30777-Q751-Z (CUPR) for OSBIZ X3R UNIFY (S30777-U774-X901) or OCTOPUS F X3R (S30777-U774-T913)
- S30777-Q750-Z (CUCR) for OSBIZ X5R UNIFY (S30777-U776-X901) or OCTOPUS F X5R (S30777-U776-T913)

The kit OpenScape Business RACK PSU UPG (C39165-A7021-D6) contains OCPSM, OSPSA adapter, mains connection cable, label as well as necessary screws and cable straps.



---

#### **WARNING**

##### **Some precautions should be taken when handling the new PSU (OCPSM PSU):**

- Do not hold the PSU by the heat sinks. The PSU must be held at PCBA edge, by two hands.
- The PSU comes with two protect foams and a plastic bag. First remove the plastic bag, and then remove the two protect foams.

---

#### **Remarks:**

- Power Box/PB3000 as battery backup power is no longer supported. If any backup power is needed, the customer has to use a UPS (e.g.: nobreak).
- The SLAD modules (S30810-Q2956 and S30810-Q2957) are not supported.

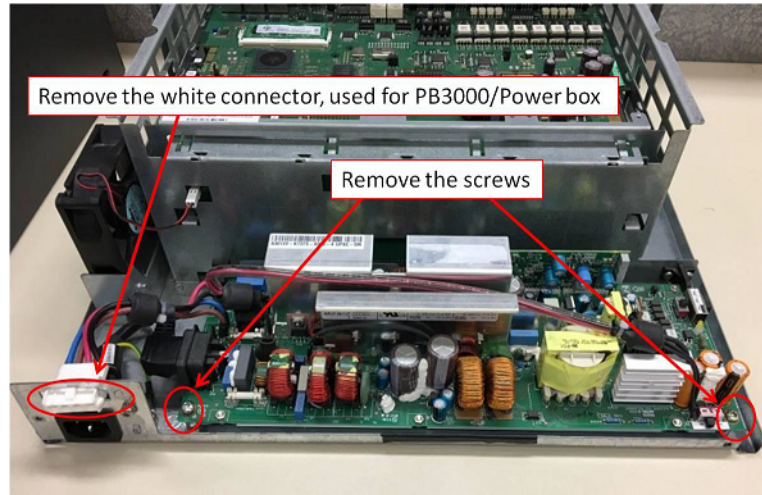
## Boards

### Description of the Boards

#### Step by Step

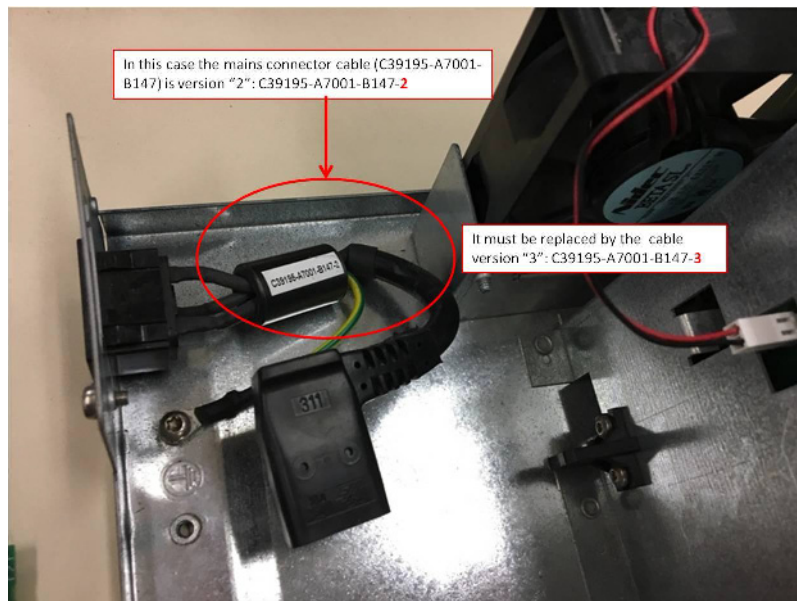
- 1) Disconnect all power supply circuits of the communication system.
- 2) Make sure that the communication system is de-energized.
- 3) Remove the UPSC-DR PSU from the system.

It is necessary to remove the screws and then remove the PSU as indicated:



- 4) Replace the AC mains connector cable when necessary.

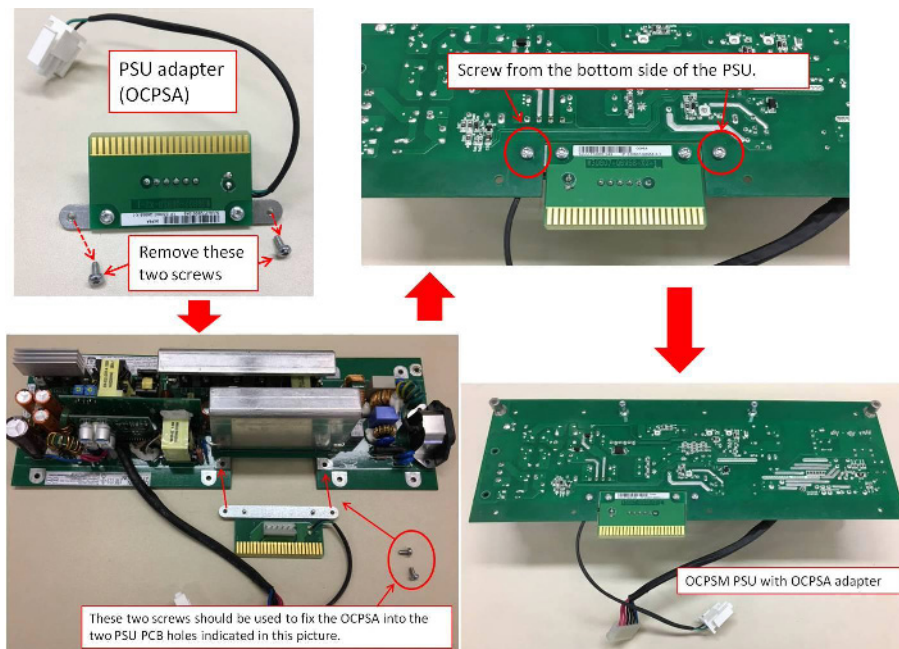
If the mains connector cable (C39195-A7001-B147) installed in the customer system is version "1" or version "2", please replace it with the version "3" (C39195-A7001-B147-3), as indicated below:



The AC connector cable version "3" is supplied together with the kit.



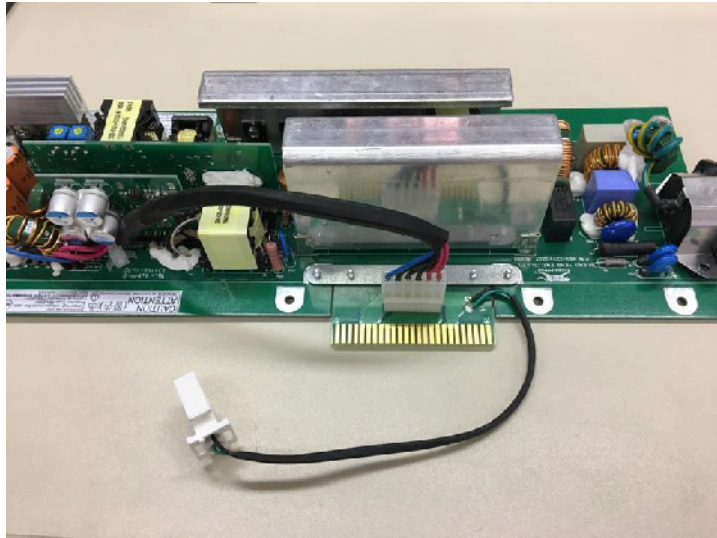
5) Connect the OCP5A adapter to the OCP5M PSU as indicated below:



6) Connect the PSU output cable into the OCP5A connector.

## Boards

### Description of the Boards



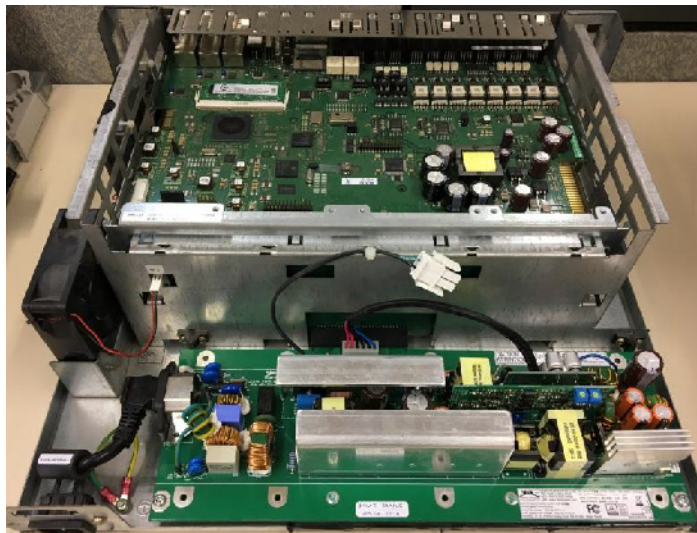
---

**INFO:** Take care with the polarity of the PSU output cable connector when connecting it to the OCPSA adapter, and also take care with the position of the pins (all pins must be connected).

---

- 7) Install the OCPSM PSU into the system.

After attaching the OCPSA adapter to the OCPSM PSU, install the OCPSM PSU into the system as indicated below and then screw the two screws. Note that the AC mains connector cable should be connected correctly to the OCPSM AC mains connector.





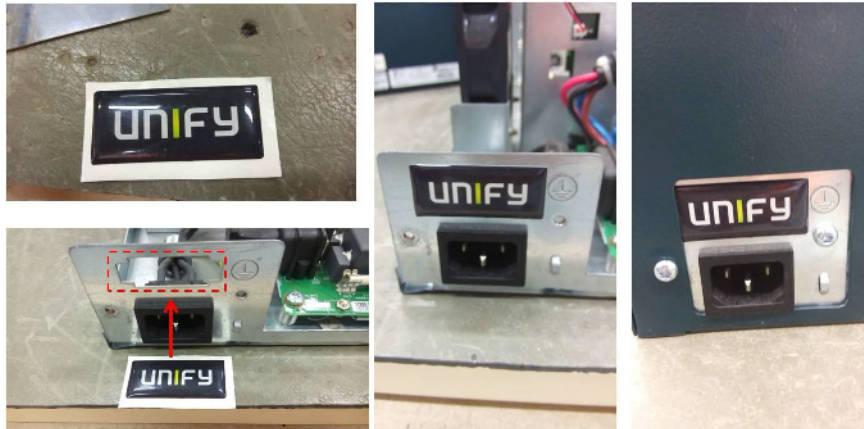
- 8) Place the Unify logo label or the Octopus logo label at the open hole at rear side of system housing, according to the customer system.

If the customer system is an Unify system:

OpenScape Business X3R UNIFY (S30777-U774-X901) or

OpenScape Business X5R UNIFY (S30777-U776-X901)

with Unify logo at front side of the system, it should be placed the Unify logo label at the open hole at rear side of the system housing, as indicated below:



### 3.2.23 REALS

The REALS (Relay and ALUM for SAPP) board provides four relays (actuators) for special connections (such as door openers) and enables a trunk failure transfer (ALUM).

#### Board Variants and their Use

Board	Part Number	Used in		Maximum number
		Communication system	Country	
REALS	S30807-Q6629-X	OpenScape Business X8	ROW	1

**NOTICE:** Fire hazard due to surge voltage

In the case of line lengths exceeding 500 m and where the lines exit the building, the REALS board must be protected by external lightning protection.

Lightning protection of this kind is known as additional primary protection. The additional primary protection is guaranteed by installing ÜSAGs (surge arresters, gas filled) in the main distribution frame, the patch panel or at the entry point of the pipe in the building. A gas-filled surge arrester with 230 V nominal

voltage is switched to ground from each wire that is to be protected.

---

### Main Features

The board supports

- four individual, controllable relays for special connections such as door openers. The switch contacts for all relays are floating and protected by surge protectors.

Electrical characteristics of the relays:

- Operating voltage: +5 V
- Contact current: max 1.25 A
- Contact rating: max. 30 W
- a trunk failure transfer (ALUM). In the event of a power failure or a fatal system error, an analog trunk is directly connected to an analog telephone. If the power supply voltage returns and a trunk call is in progress, switchover of the trunk failure transfer relay is prevented by the optocoupler.

ALUM relay positions:

- Communication system during normal operation  
PFTALa/b (analog trunk) is connected to PFTASa/b (analog trunk board).  
PFTTLa/b (analog telephone) is connected to PFTTSa/b (analog subscriber line module).
- Communication system without power supply  
PFTTLa/b (analog telephone) is connected to PFTALa/b (analog trunk).

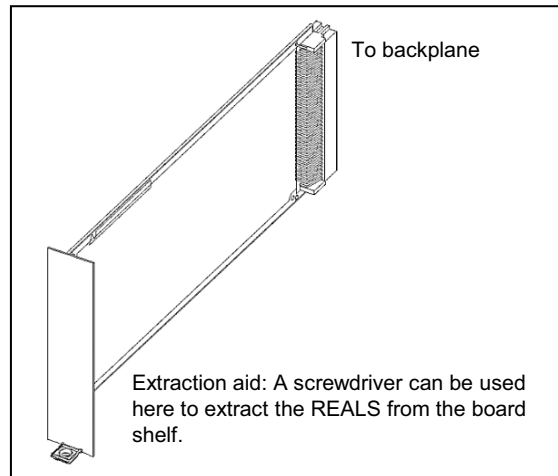
ALUM relay electrical data:

- Operating voltage: +5 V
- Contact current: max 1.25 A
- Contact rating: max. 30 W
- Two -48-V outputs fused using a PTC resistor. Each of the two outputs has a maximum load capacity of 0.3 A.
  - Output 1: M48VF1 / 0V\_F
  - Output 2: M48VF2 / 0V\_F

All of the functions are controlled by the OCCL board.

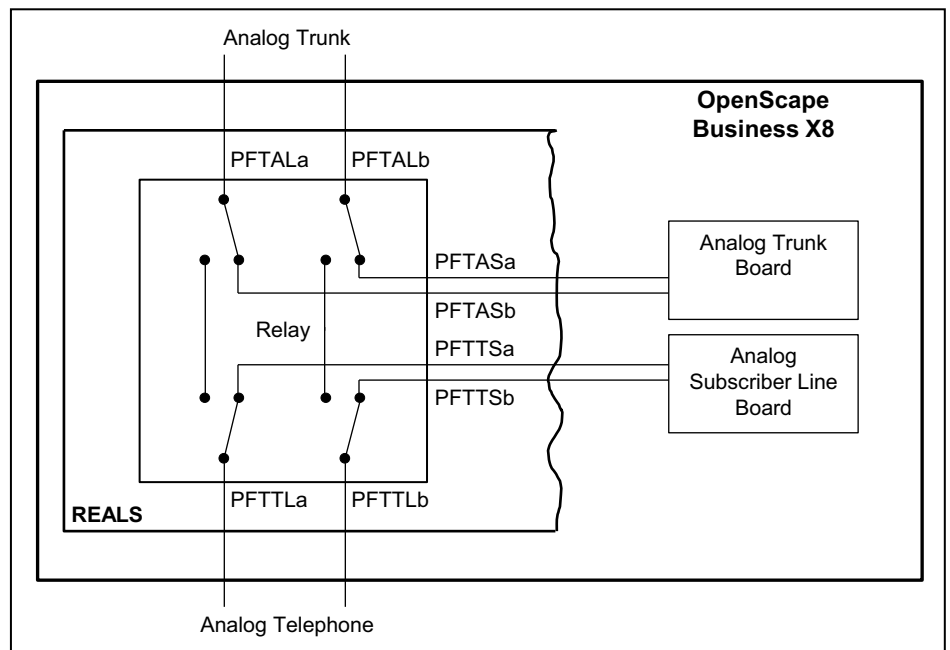
**Figure**

**Figure:** REALS



**Block Diagram**

**Figure:** REALS – Block Diagram (Communication System during Normal Operation)

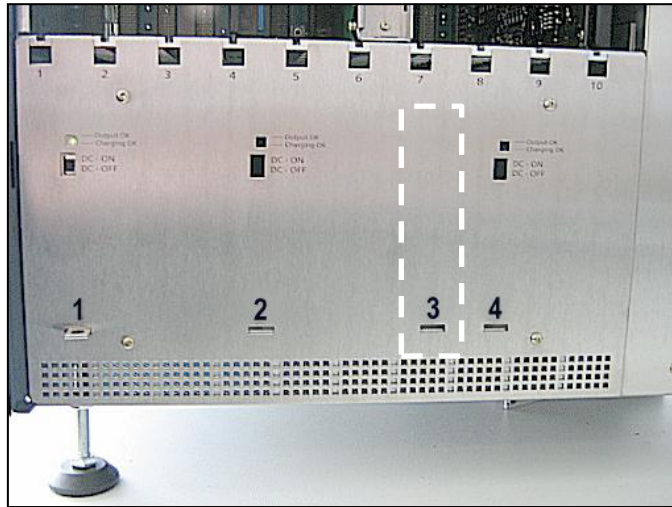


**Slot**

The slot for the REALS board is located in the lower part of the shelf of the base box.

The slots of the power supply units and the slot of the REALS board must be covered with the outer panel shown in the figure below before the communication system is started up.

**Figure:** REALS – Slot 3 in the Base box



**Cable and Pin Assignments**

The REALS board is connected via the SIVAPAC connector X116 on the backplane of the base box.

**Table:** REALS – Cable and Pin Assignments (SIVAPAC Connectors X116 on the Backplane)

REALS	Backplane SIVAPAC connector X116	Connection cable (open-end cable with 24 TW)			
Signal	Pin	Color Group	Pair	A-wire	B-wire
M48VF1	20	1	1	white/blue	
0V_F	38				blue/white
PFTTLb	18		2	white/orange	
PFTTLa	17				orange/white
0 V	16		3	white/green	
–	15				green/white
0V_F	14		4	white/brown	
M48VF2	13				brown/white
–	12		5	white/gray	
0 V	11				gray/white



REALS	Backplane SIVAPAC connector X116	Connection cable (open-end cable with 24 TW)			
		Signal	Pin	Color Group	Pair
AK1	10	2	6	red/blue	
AK2	9				blue/red
AK3	8		7	red/orange	
AK4	7				orange/red
0 V	6		8	red/green	
PFTASa	5				green/red
PFTASb	4		9	red/brown	
PFTALa	3				brown/red
PFTALb	2		10	red/gray	
–	1				gray/red
–	37	3	11	black/blue	
0 V	36				blue/black
–	35		12	black/orange	
–	34				orange/black
RK3	32		13	black/green	
0 V	31				green/black
RK1	30		14	black/brown	
RK2	29				brown/black
RK4	27		15	black/gray	
0 V	26				gray/black
PFTTSb	24	4	16	yellow/blue	
PFTTSa	23				blue/yellow
–	58		17	yellow/orange	
S5	57				orange/yellow
0 V	56		18	yellow/green	
–	55				green/yellow
–	54		19	yellow/brown	
S3	53				brown/yellow
S4	52		20	yellow/gray	
0 V	51				gray/yellow

## Boards

### Description of the Boards

REALS	Backplane SIVAPAC connector X116	Connection cable (open-end cable with 24 TW)			
Signal	Pin	Color Group	Pair	A-wire	B-wire
UK1	50	5	21	purple/blue	
UK2	49				blue/purple
UK3	48		22	purple/orange	
UK4	47				orange/purple
0 V	46		23	purple/green	
–	45				green/purple
–	44		24	purple/brown	
S6	43				brown/purple

### 3.2.24 SLAV4, SLAV8, SLAV8R

The SLAV4, SLAV8 and SLAV8R (Subscriber Line Analog with Vinetic, Rack) boards provide four (SLAV4) and eight a/b interfaces (SLAV8 and SLAV8R) for connecting analog telephones and devices (fax, modem, etc.).

The SLAV4, SLAV8 and SLAV8R boards are compatible successor modules for the following boards, which will be discontinued:

- SLAD4 (S30810-Q2956-X100)
- SLAD8 (S30810-Q2956-X200)
- SLAD8R (S30810-K2956-X300)

#### Temperature Monitoring

The temperature of the system is monitored. At temperatures higher than 61 degrees Celsius, a notification can be sent to up to three system telephones with a display, by e-mail or through signaling via an SNMP trap. Entries are made in the event log and event viewer (client trace) only if the system exceeds or falls below the critical temperatures. Logging occurs in the message log so long as the value is less than or equal to 58° Celsius.

At temperatures above 66 °C, the message "Alarm: critical system temperature!" is displayed on the home page of the OpenScape Business Assistant (WBM). The installed SLAV8/SLAV8R boards (also applies to SLAD8/SLAD8R) are switched off. Then, the system must be shut down and disconnected from the power supply. After checking the SLAV/SLAD boards, the system can be reconnected to the power supply and restarted. The alarm is thus cleared, and the SLAV/SLAD boards are put back into operation.

### Board Variants and their Use

Board	Part Number	Used in		Maximum number
		Communication system	Country	
SLAV4	S30810-H2963-X100	X3W	ROW	2
		X5W		Is determined by the system-specific capacity limits.
SLAV8	S30810-H2963-X200	X3W	ROW	2
		X5W		Is determined by the system-specific capacity limits.
SLAV8R	S30810-H2963-Z200	X3R	ROW	2
		X5R		Is determined by the system-specific capacity limits.

### Main Features

The boards support

- calling name identification presentation (CLIP).
- the connection of external extensions via OPS (Off-Premises Station) signaling.

For U.S. only: The following maximum numbers for connecting external extensions (via OPS signaling) must not be exceeded for SLAV4 and SLAV8 boards:

- OpenScape Business X3R and OpenScape Business X3W: maximum 4
- OpenScape Business X5R and OpenScape Business X5W: maximum 8

---

**NOTICE:** Fire hazard due to surge voltage

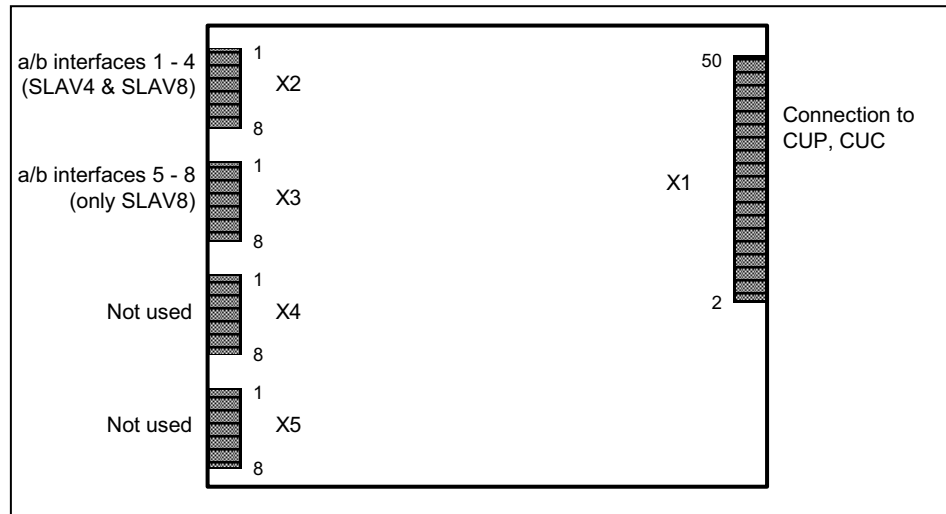
In the case of line lengths exceeding 500 m and where the lines exit the building, the SLAV4, SLAV8 and SLAV8R boards must be protected by external lightning protection.

Lightning protection of this kind is known as additional primary protection. The additional primary protection is guaranteed by installing ÜSAGs (surge arresters, gas filled) in the main distribution frame, the patch panel or at the entry point of the pipe in the building. A gas-filled surge arrester with 230 V nominal voltage is switched to ground from each wire that is to be protected.

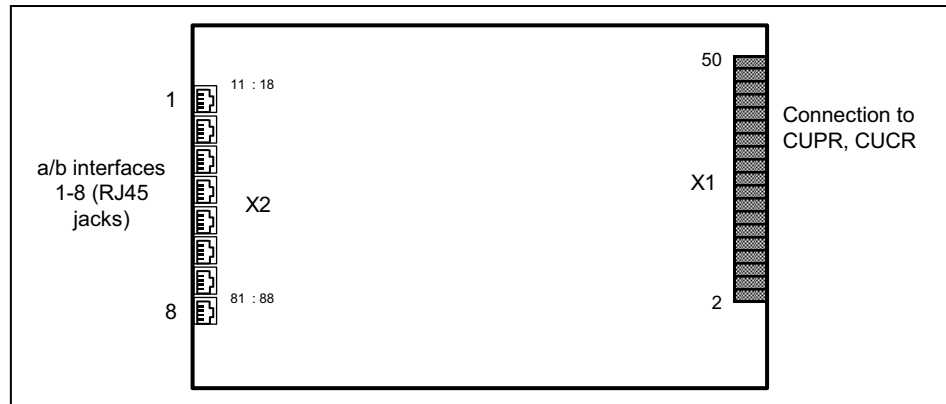
---

**Figure**

**Figure:** SLAV4, SLAV8



**Figure:** SLAV8R



**Pin Assignments**

**Table:** SLAV4, SLAV8 - Pin Assignments

X2 (SLAV4 & SLAV8)		X3 (only SLAV8)	
Pin	a/b interfaces 1 – 4	Pin	a/b interfaces 5 – 8
1	a 1	1	a 5
2	b 1	2	b 5
3	a 2	3	a 6
4	b 2	4	b 6
5	a 3	5	a 7
6	b 3	6	b 7
7	a 4	7	a 8
8	b 4	8	b 8

**Table:** SLAV8R - Pin Assignments

RJ45 jack	Pin	a/b interfaces 1 – 8
1	14	a 1
	15	b 1
2	24	a 2
	25	b 2
3	34	a 3
	35	b 3
4	44	a 4
	45	b 4
5	54	a 5
	55	b 5
6	64	a 6
	65	b 6
7	74	a 7
	75	b 7
8	84	a 8
	85	b 8
The RJ45 jacks each have two wires.		

### 3.2.25 SLAV16, SLAV16R

The SLAV16 and SLAV16R (Subscriber Line Analog with Vinetic, Rack) boards provide 16 a/b interfaces for connecting analog telephones and devices (fax, modem, etc.).

The SLAV16 board is the compatible successor module for the SLAD16 board (S30810-Q2957-X), which will be discontinued.

#### Temperature Monitoring

The temperature of the system is monitored. At temperatures higher than 61 degrees Celsius, a notification can be sent to up to three system telephones with a display, by e-mail or through signaling via an SNMP trap. Entries are made in the event log and event viewer (client trace) only if the system exceeds or falls below the critical temperatures. Logging occurs in the message log so long as the value is less than or equal to 58° Celsius.

At temperatures above 66 °C, the message "Alarm: critical system temperature!" is displayed on the home page of the OpenScape Business Assistant (WBM). The installed SLAV16/SLAV16R boards (also applies to SLAD16) are switched off. Then, the system must be shut down and disconnected from the power supply. After checking the SLAV/SLAD boards, the system can be reconnected to the

## Boards

### Description of the Boards

power supply and restarted. The alarm is thus cleared, and the SLAV/SLAD boards are put back into operation.

### Board Variants and their Use

Board	Part Number	Used in		Maximum number
		Communication system	Country	
SLAV16	S30810-H2963-X	X3W	ROW	1
		X5W	ROW	Is determined by the system-specific capacity limits, max. 4
			U.S., Canada	1
SLAV16R	S30810-H2963-Z	X3R	ROW	1
		X5R	ROW	Is determined by the system-specific capacity limits, max. 4
			U.S., Canada	1

The following notes must be observed when installing boards:

- **OpenScape Business X3W/X3R**

The OpenScape Business X3W/X3R can be equipped with a maximum of one SLAV16(R) board. The following rules must be observed when using an SLAV16(R) to ensure optimal heat dissipation in the communication system.

- The following boards must never be plugged into the second slot: 4SLA, 8SLA, 16SLA, SLAD4, SLAD8(R), SLAD16, SLAV4, SLAV8(R), SLAV16(R)
- A maximum of 20 analog phones and devices can be connected (including the a/b interfaces on the OCCM mainboard).
- A fan kit is not required for the X3W; the X3R already has a fan installed.

- **OpenScape Business X5W/X5R**

The OpenScape Business X5W/X5R can be equipped with multiple SLAV16(R) boards. Their number is determined by the system-specific capacity limits, max. 4 SLAV16(R). The following rules must be observed when using an SLAV16(R) to ensure optimal heat dissipation in the communication system.

- It is crucial that the following slot allocation sequence for SLAV16 boards be observed: first slot 6, then 8, then 4, and then 7. Slots not filled with SLAV16(R) boards can be populated with other boards.
- Depending on the loop current and the number of SLAV16(R) boards, the following table indicates whether or not the installation of a fan kit is required. The fan kit provides additional cooling for the communication system.

---

**INFO:** if the old housing cover is still being used for the X5W, the fan kit C39165-A7021-B46 must be installed. This fan kit is not approved in the U.S. and Canada. In these two countries, only system configurations where no fan kit is required are allowed.

If the new housing cover is used for the X5W, the fan kit C39165-A7021-B310 must be installed.

For the X5R, the fan kit C39117-A7003-B612 must be installed.

If a UC Booster Card incl. fan kit is already installed, the installed fan kit can continue to be used.

---

On selecting the system country code, the appropriate country-specific loop current will be set for the SLAV16 board (default). Changes to these settings are only possible for selected countries using Manager E (**Station view > Flags: Usage** drop-down list).

Countries	Loop current	
	Low loop current (default setting)	High loop current
Germany and all other countries not listed below	32 mA (no change possible) Fan Kit required as of 3 x SLAV16(R)	
U.S., Canada	37 mA (no change possible) A maximum of one SLAV16(R) may be used.	
Argentina, Australia, Bolivia, Brazil, Chile, Costa Rica, Dominican Republic, Ecuador, El Salvador, Guatemala, Honduras, Colombia, Mexico, Panama, Paraguay, Peru, Uruguay, Venezuela	18 mA No fan kit required	32 mA Fan Kit required as of 3 x SLAV16(R)
South Korea	20 mA No fan kit required	32 mA Fan Kit required as of 3 x SLAV16(R)
New Zealand	20 mA (at 450 ohm load) No fan kit required	32 mA Fan Kit required as of 3 x SLAV16(R)
	15 mA (at 1000 ohm load) No fan kit required	
Hong Kong, Indonesia, Malaysia, Philippines, Singapore, Taiwan, Thailand, Vietnam	22 mA No fan kit required	32 mA Fan Kit required as of 3 x SLAV16(R)
China, India	27 mA Fan Kit required as of 3 x SLAV16(R)	32 mA Fan Kit required as of 3 x SLAV16(R)

## Boards

### Description of the Boards

---

**INFO:** To avoid overloading the system-internal power supply, the secondary power requirements for each system configuration must be verified (see ).

---

#### Main Features

These boards support calling name identification presentation (CLIP).

The connection of external extensions via OPS (Off-Premises Station) signaling is prohibited.

---

**NOTICE:** Fire hazard due to surge voltage

In the case of line lengths exceeding 500 m and where the lines exit the building, the SLAV16 and SLAV16R boards must be protected by external lightning protection.

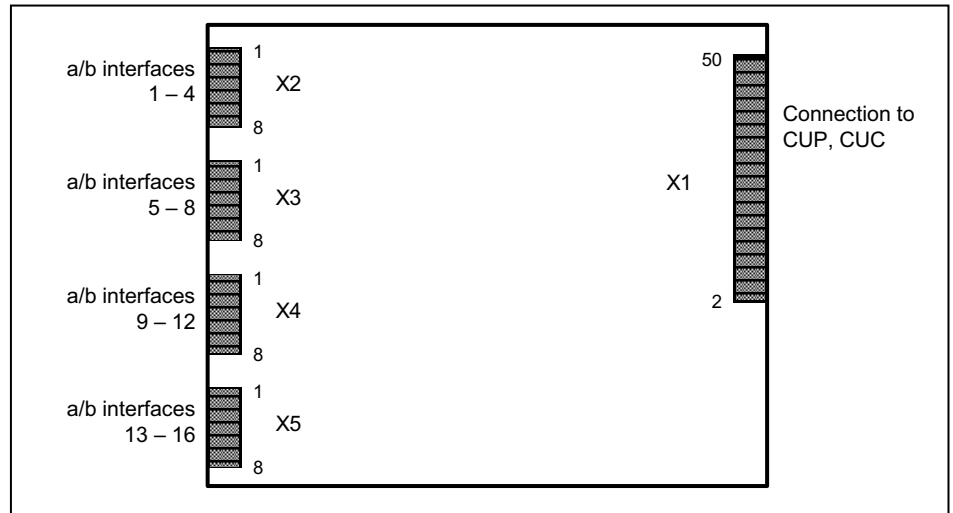
Lightning protection of this kind is known as additional primary protection. The additional primary protection is guaranteed by installing ÜSAGs (surge arresters, gas filled) in the main distribution frame, the patch panel or at the entry point of the pipe in the building. A gas-filled surge arrester with 230 V nominal voltage is switched to ground from each wire that is to be protected.

---

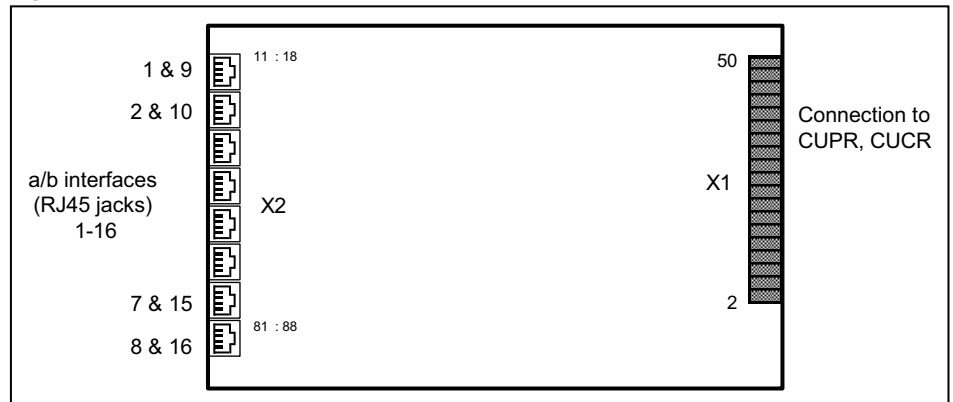


**Figure**

**Figure: SLAV16**



**Figure: SLAV16R**



**Pin Assignments**

**Table: SLAV16 - Pin Assignments**

X2		X3		X4		X5	
Pin	a/b interfaces 1 – 4	Pin	a/b interfaces 5 – 8	Pin	a/b interfaces 9 – 12	Pin	a/b interfaces 13 – 16
1	a 1	1	a 5	1	a 9	1	a 13
2	b 1	2	b 5	2	b 9	2	b 13
3	a 2	3	a 6	3	a 10	3	a 14
4	b 2	4	b 6	4	b 10	4	b 14
5	a 3	5	a 7	5	a 11	5	a 15

## Boards

### Description of the Boards

X2		X3		X4		X5	
Pin	a/b interfaces 1 – 4	Pin	a/b interfaces 5 – 8	Pin	a/b interfaces 9 – 12	Pin	a/b interfaces 13 – 16
6	b 3	6	b 7	6	b 11	6	b 15
7	a 4	7	a 8	7	a 12	7	a 16
8	b 4	8	b 8	8	b 12	8	b 16

**Table:** SLAV16R - Pin Assignments

RJ45 jack	Pin	a/b interfaces 1 – 16
1	14	a 1
	15	b 1
	16	a 9
	13	b 9
2	24	a 2
	25	b 2
	26	a 10
	23	b 10
3	34	a 3
	35	b 3
	36	a 11
	33	b 11
4	44	a 4
	45	b 4
	46	a 12
	43	b 12
5	54	a 5
	55	b 5
	56	a 13
	53	b 13
6	64	a 6
	65	b 6
	66	a 14
	63	b 14
7	74	a 7
	75	b 7
	76	a 15
	73	b 15

RJ45 jack	Pin	a/b interfaces 1 – 16
8	84	a 8
	85	b 8
	86	a 16
	83	b 16
The RJ45 jacks each have two wires.		

### 3.2.25.1 How to Install a Fan Kit in an OpenScape Business X5W

Fan Kit C39165-A7021-B310 provides cooling for the OpenScape Business X5W communication system when extensive system configurations with the SLAV16/SLAV16R or SLAD16 boards are present.




---

#### **DANGER**

##### **Risk of electric shock through contact with live wires**

Disconnect all power supply circuits of the OpenScape Business X5W communication system before opening the housing:

- Disconnect the battery voltage, supply voltage and line voltage at any connected OpenScape Business Powerbox.
  - Disconnect the line cords of any connected battery pack or any connected batteries.
  - Disconnect the power plug of the communication system.
- 

#### **Step by Step**

- 1) Disconnect all power supply circuits of the communication system.
- 2) Make sure that the communication system is de-energized.
- 3) Loosen the two fixing screws on the housing cover with a slotted screw driver. Hold the housing cover so that it does not fall.

## Boards

### Description of the Boards



4) Remove the housing cover.



---

#### **CAUTION**

##### **Cuts caused by sharp edges on the shielding plate**

Make sure that you only touch the outside of the housing cover. The shielding plate on the inside of the housing cover may have sharp edges which can cause cuts.

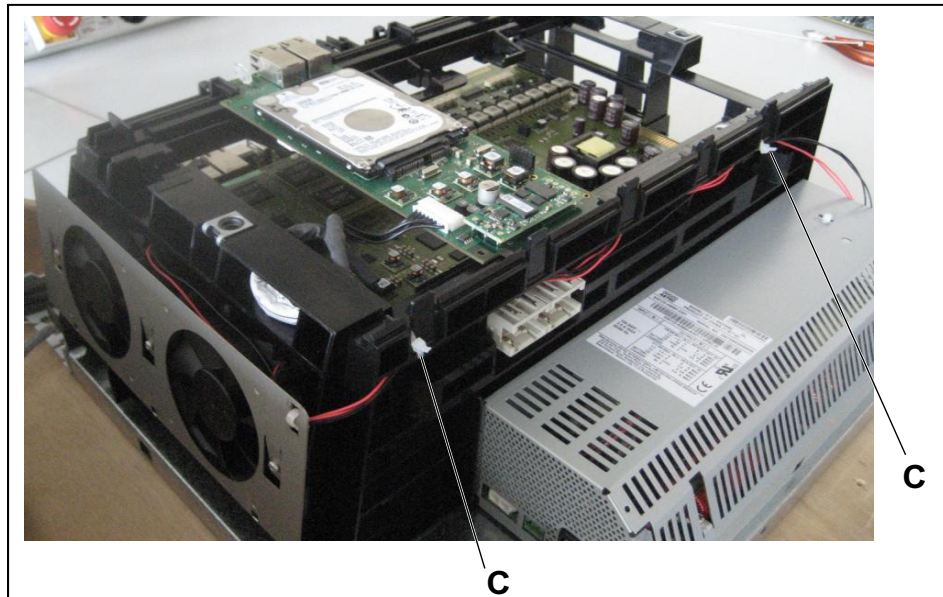
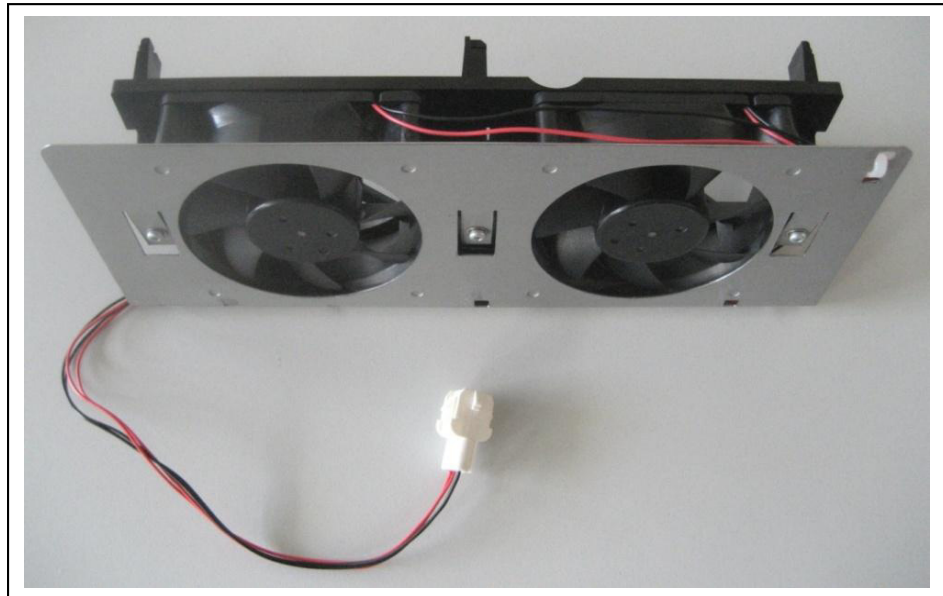
---



- 5) Pull out the two enclosed cable ties from the fan kit.
- 6) Lock the fan kit with the snap hooks to the bottom of the board frame. The arrows on the fan housing point into the system, i.e., the cold air must be blown into the system.

## Boards

### Description of the Boards



- 7) Fix the fan power cable to the housing with the two cable ties (C) supplied.
- 8) Connect the fan power cable to the open side of the UPSC-D power supply.
- 9) **Only for migration of HiPath 3000:** If the UPSC-D power supply does not have a fan kit power connector (up to UPSC-D S30122-H5660-X300), you will also need a new power supply (as of UPSC-D S30122-K5660-X301).
- 10) Put on the new housing cover. Make sure that the two recesses in the housing cover are facing downward.
- 11) Secure the housing cover with the two screws. Make sure that you only touch the outside of the housing cover. The shielding plate on the inside of the housing cover may have sharp edges which can cause cuts.

- 12) Place the OpenScape Business X5W communication system back into operation.

### 3.2.25.2 How to Install a Fan Kit in an OpenScape Business X5R

The Fan Kit C39117-A7003-B612 provides cooling for the OpenScape Business X5R communication system when extensive system configurations with the SLAV16/SLAV16R or SLAD16 boards are present.



#### **DANGER**

##### **Risk of electric shock through contact with live wires**

Disconnect all power supply circuits of the OpenScape Business X5R communication system before opening the housing:

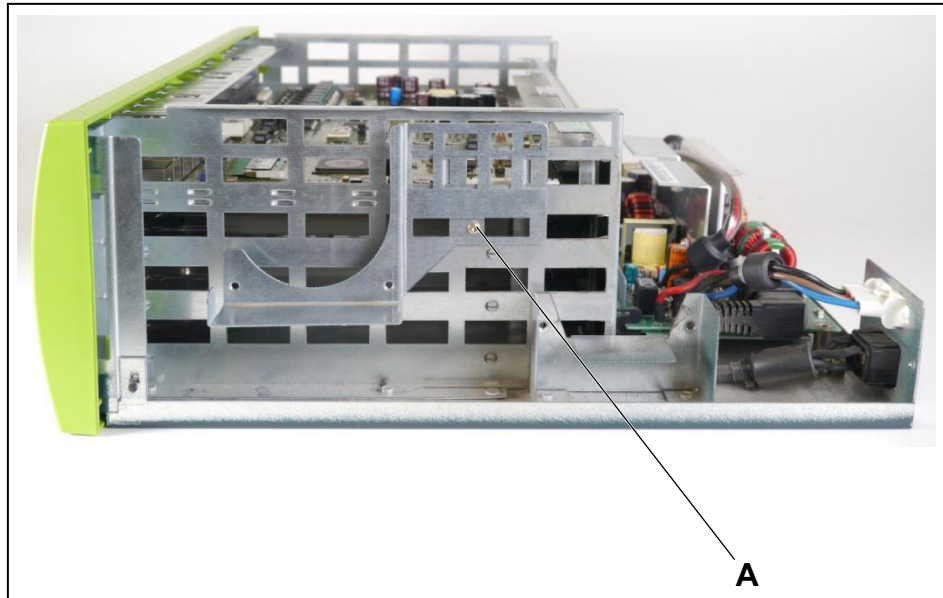
- Disconnect the battery voltage, supply voltage and line voltage at any connected OpenScape Business Powerbox.
  - Disconnect the line cords of any connected battery pack or any connected batteries.
  - Disconnect the power plug of the communication system.
- 

#### **Step by Step**

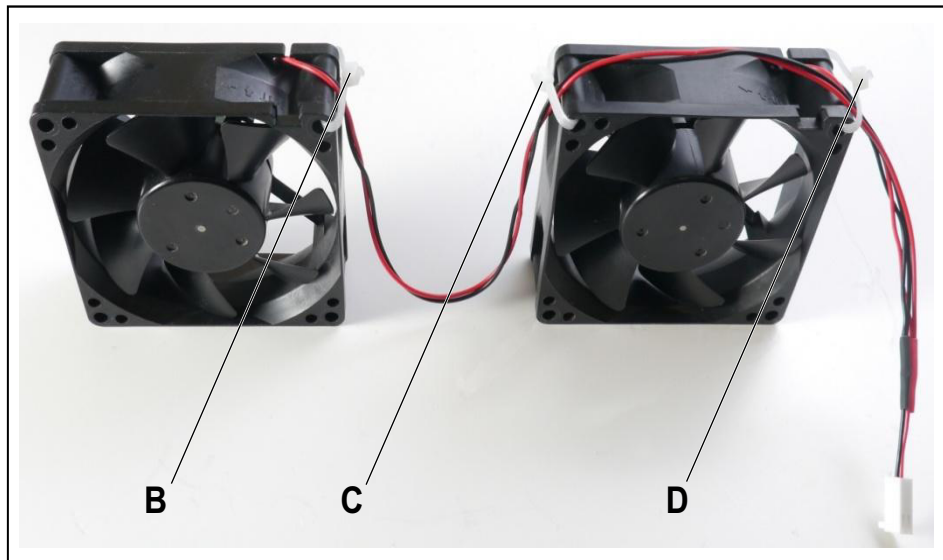
- 1) Disconnect all power supply circuits of the communication system.
- 2) Make sure that the communication system is de-energized.
- 3) If the system is installed in a 19" rack, remove the system from the 19" rack.
- 4) Using a T20 Torx screwdriver, remove the screws and lift off the cover.
- 5) Disconnect the fan power cable from the backplane. To do this, push the small white lever on the socket down and pull off the plug.
- 6) Remove the two screws of the fan and pull out the old fan by sliding it upwards.
- 7) Clamp the fan bracket laterally to the frame housing and secure the bracket with the supplied screw (A).

## Boards

### Description of the Boards

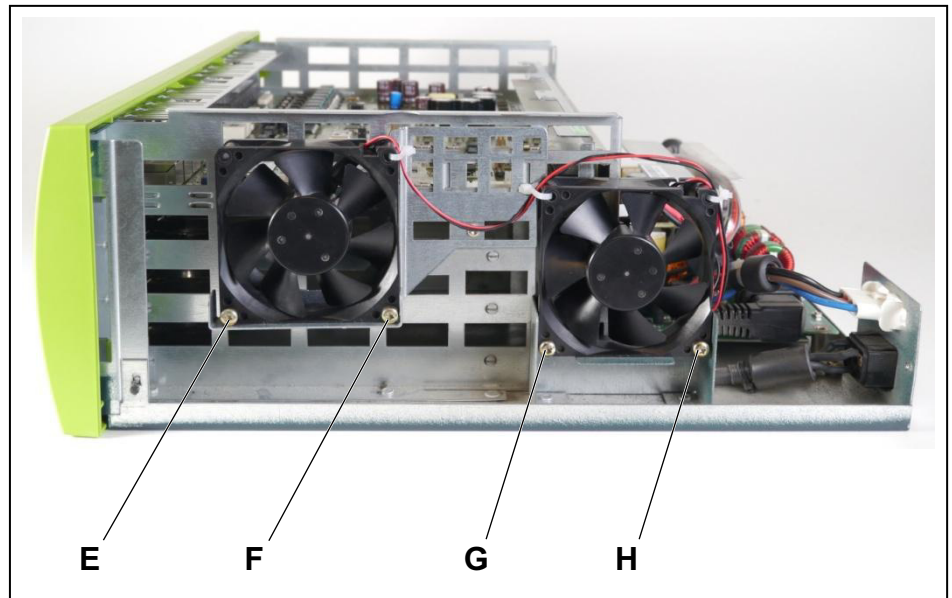


- 8) First, fix the fan power cable to the fans using the three supplied cable ties (B, C and D). If the fans are placed in the brackets before fixing the power cable, it is very difficult to insert the cable ties into the fan.



- 9) Insert the two new fans into the brackets provided for this purpose and fix the fans to the brackets with the supplied screws (E, F, G and H). Pay special attention to the correct air flow direction, which is indicated by arrows on the fan housing (the arrows point into the system, i.e., the cold air must be blown into the system).





- 10)** Connect the new fan power cable to the backplane socket, where the old fan power cable was previously plugged.
- 11)** If the system was installed in a 19" rack, put the system back into the 19" rack.
- 12) Only when migrating from HiPath 3000:** The new housing cover C39165-A7027-B207 with additional air vents is required for the fan kit.
- 13)** Screw on the housing cover again.
- 14)** Put the communication system into operation (see the section "Initial Installation of OpenScape Business X3/X5/X8" in the OpenScape Business Administrator Documentation).

### 3.2.26 Not for U.S.: SLC16N

The SLC16N (Subscriber Line Module Cordless New) board provides 16  $U_{P0/E}$  interfaces for connecting DECT base stations to the integrated cordless solution.

---

**NOTICE:** SLC16N (S30810-Q2193-X100) is being phased out and can no longer be ordered. However, they can still be connected to OpenScape Business X communication systems.

---

For information on the installation and connection of DECT base stations, see [Integrated Cordless Solution](#).

**Board Variants and their Use**

Board	Part Number	Used in		Maximum number
		Communication system	Country	
SLC16N	S30810-Q2193-X100	OpenScape Business X5W	ROW (not for U.S.)	1

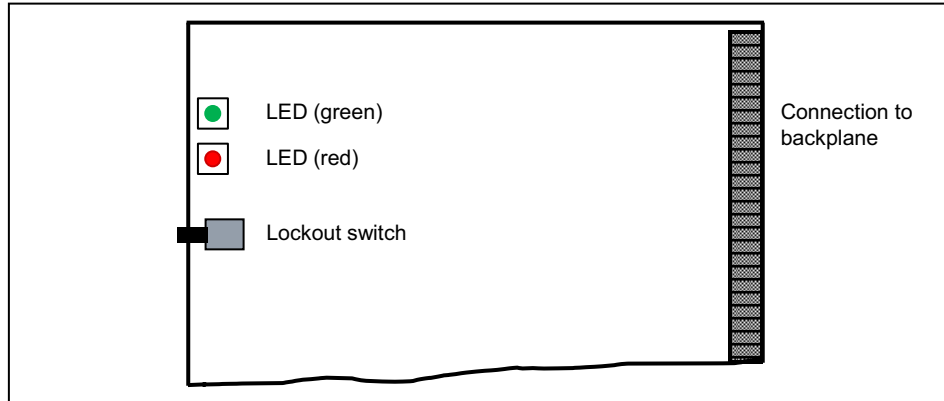
**NOTICE:** Fire hazard due to surge voltage

In the case of line lengths exceeding 500 m and where the lines exit the building, the SLC16N board must be protected by external lightning protection.

Lightning protection of this kind is known as additional primary protection. The additional primary protection is guaranteed by installing ÜSAGs (surge arresters, gas filled) in the main distribution frame, the patch panel or at the entry point of the pipe in the building. A gas-filled surge arrester with 230 V nominal voltage is switched to ground from each wire that is to be protected.

**Figure**

**Figure:** SLC16N



**Lockout switch**

The board includes a lockout switch with the following functions:

- Lockout switch not pressed = board is in normal operation (factory default)
- Lockout switch pressed = board locked: all idle mobile phones are locked. Active mobile phones will be locked when the call ends.

Press the lockout switch before removing the SLC16N board. Wait until the green LED stops flashing. This precaution ensures that none of the mobile phones are active.

### LEDs

The board features two LEDs that indicate the operating states.

**Table:** SLC16N – LED Statuses and their Meanings

Red LED	Green LED	Meaning	Action
off	off	Board not receiving power or not plugged in correctly. Board is out of order.	Check plug contact on board.
on	off	Board is supplied with power. Board test in progress.	–
		Loadware loading failed. Board is faulty.	Replace board.
		Board was deactivated using Manager E.	Check whether the board was deactivated using Manager E. If not, the board is defective and must be replaced.
flashing	off	Loadware loading in progress.	–
off	on	Loadware loading completed successfully. Board is OK (idle state).	–
off	flashing	At least one channel is activated.	–
on	on	Board is disabled.	Check whether board was deactivated using the lockout switch.

### Cable and Pin Assignments

CABLUs are used for connecting the external main distribution frame MDFU-E or the external patch panel.

## Boards

### Description of the Boards

**Table:** SLC16N – Cable and Pin Assignments (Backplane, MDFU-E, Patch Panel)

SLC16N U <sub>P0/E</sub> interface		Backplane SIPAC 1 SU connector(s) X8	Connection cable (CABLU)				MDFU-E	Patch Panel RJ45 jack	
No.	Signal	Pin	Color Group	Pair	A-wire	B-wire	Jumper strip	No.	Pin
1	1a	19	1	1	white/blue		1a	1	4
	1b	39				blue/white	1b		5
2	2a	38		2	white/orange		2a	2	4
	2b	48				orange/white	2b		5
3	3a	27		3	white/green		3a	3	4
	3b	47				green/white	3b		5
4	4a	16		4	white/brown		4a	4	4
	4b	46				brown/white	4b		5
5	5a	05		5	white/gray		5a	5	4
	5b	45				gray/white	5b		5
6	6a	14	2	6	red/blue		6a	6	4
	6b	44				blue/red	6b		5
7	7a	23		7	red/orange		7a	7	4
	7b	43				orange/red	7b		5
8	8a	32		8	red/green		8a	8	4
	8b	42				green/red	8b		5
9	9a	11		9	red/brown		9a	9	4
	9b	31				brown/red	9b		5
10	10a	02		10	red/gray		10a	10	4
	10b	22				gray/red	10b		5

SLC16N U <sub>P0/E</sub> interface		Backplane SIPAC 1 SU connector(s) X8	Connection cable (CABLU)				MDFU-E	Patch Panel RJ45 jack		
No.	Signal	Pin	Color Group	Pair	A-wire	B-wire	Jumper strip	No.	Pin	
11	11a	13	3	11	black/blue		11a	11	4	
	11b	33				blue/black	11b		5	
12	12a	04		12	black/orange		12a	12	4	
	12b	24				orange/black	12b		5	
13	13a	15		13	black/green		13a	13	4	
	13b	35				green/black	13b		5	
14	14a	06		14	black/brown		14a	14	4	
	14b	26				brown/black	14b		5	
15	15a	17		15	black/gray		15a	15	4	
	15b	37				gray/black	15b		5	
16	16a	08		4	16	yellow/blue		16a	16	4
	16b	28					blue/yellow	16b		5

### 3.2.27 Not for U.S.: SLCN

The SLCN (Subscriber Line Module Cordless New) board provides 16 U<sub>P0/E</sub> interfaces for connecting DECT base stations to the integrated cordless solution.

For information on the installation and connection of DECT base stations, see [Integrated Cordless Solution](#).

#### Board Variants and their Use

Board	Part Number	Used in		Maximum number
		Communication system	Country	
SLCN	S30810-Q2193-X300	OpenScape Business X8	ROW (not for U.S.)	4

**INFO:** To guarantee uninterrupted operation of OpenScape Business X8, no more than two SLCN boards should be plugged into any of the PCM segments. For information on the distribution

## Boards

### Description of the Boards

of the PCM highways, please refer to the *OpenScape Business X3/X5/X8, Installation Guide*

One slot should be kept free between two SCLN boards to prevent overheating.

When the new SLCN card is inserted it will start being loaded into the system and since it doesn't know of any other running cards this could lead to a reboot of the other SLCN cards.

When the new card is given its SLC-No then the multi-SLC-Table is changed. All SLCN in system must be informed and therefore a reset to all SLCN's is send to boards.

This installation procedure might cause DECT functionality to be out of service temporarily.

---

---

#### **NOTICE:** Fire hazard due to surge voltage

In the case of line lengths exceeding 500 m and where the lines exit the building, the SLCN board must be protected by external lightning protection.

Lightning protection of this kind is known as additional primary protection. The additional primary protection is guaranteed by installing ÜSAGs (surge arresters, gas filled) in the main distribution frame, the patch panel or at the entry point of the pipe in the building. A gas-filled surge arrester with 230 V nominal voltage is switched to ground from each wire that is to be protected.

---

### Front Panel

**Figure:** SLCN – LEDs on the Front Panel



### LEDs

The board features a front panel with two LEDs that indicate the operating states.

**Table:** SLCN – LED Statuses and their Meanings

Red LED	Green LED	Meaning	Action
off	off	Board not receiving power or not plugged in correctly. Board is out of order.	Check plug contact on board.
on	off	Board is supplied with power. Board test in progress.	–
		Loadware loading failed. Board is faulty.	Replace board.
		Board was deactivated using Manager E.	Check whether the board was deactivated using Manager E. If not, the board is defective and must be replaced.
flashing	off	Loadware loading in progress.	–
off	on	Loadware loading completed successfully. Board is OK (idle state).	–
off	flashing	At least one channel is activated.	–

### Cable and Pin Assignments

There are several connection options for DECT base stations:

- SIVAPAC connectors are available on the backplane for connecting the external main distribution frame MDFU-E or the external patch panel using CABLUs (prefabricated cabling units). See [Table: SLCN – Cable and Pin Assignments \(SIVAPAC Connectors on the Backplane, MDFU-E, Patch Panel\)](#)
- Connector panels with 24 RJ45 jacks for connecting DECT base stations directly. The connector panels are clipped onto the SIVAPAC connectors on the backplane. See [Table: SLCN – Pin Assignments \(Connector Panel with 24 RJ45 Jacks\)](#)

## Boards

### Description of the Boards

**Table:** SLCN – Cable and Pin Assignments (SIVAPAC Connectors on the Backplane, MDFU-E, Patch Panel)

SLCN U <sub>P0/E</sub> interface		Backplane SIVAPAC connector	Connection cable (CABLU)				MDFU-E	Patch Panel RJ45 jack	
No.	Signal	Pin	Color Group	Pair	A-wire	B-wire	Splitting strip	No.	Pin
1	1a	1	1	1	white/blue		1a	1	4
	1b	23				blue/white	1b		5
2	2a	3		2	white/orange		2a	2	4
	2b	4				orange/white	2b		5
3	3a	5		3	white/green		3a	3	4
	3b	6				green/white	3b		5
4	4a	7		4	white/brown		4a	4	4
	4b	8				brown/white	4b		5
5	5a	9		5	white/gray		5a	5	4
	5b	10				gray/white	5b		5
6	6a	11	2	6	red/blue		6a	6	4
	6b	12				blue/red	6b		5
7	7a	13		7	red/orange		7a	7	4
	7b	14				orange/red	7b		5
8	8a	15		8	red/green		8a	8	4
	8b	16				green/red	8b		5
9	9a	17		9	red/brown		9a	9	4
	9b	18				brown/red	9b		5
10	10a	19		10	red/gray		10a	10	4
	10b	20				gray/red	10b		5



SLCN U <sub>P0/E</sub> interface		Backplane SIVAPAC connector	Connection cable (CABLU)				MDFU-E	Patch Panel RJ45 jack	
No.	Signal	Pin	Color Group	Pair	A-wire	B-wire	Splitting strip	No.	Pin
11	11a	24	3	11	black/blue		11a	11	4
	11b	25				blue/black	11b		5
12	12a	26		12	black/orange		12a	12	4
	12b	27				orange/black	12b		5
13	13a	29		13	black/green		13a	13	4
	13b	30				green/black	13b		5
14	14a	31		14	black/brown		14a	14	4
	14b	32				brown/black	14b		5
15	15a	34	15	black/gray		15a	15	4	
	15b	35			gray/black	15b		5	
16	16a	37	4	16	yellow/blue		16a	16	4
	16b	38				blue/yellow	16b		5

**Table: SLCN – Pin Assignments (Connector Panel with 24 RJ45 Jacks)**

SLCN U <sub>P0/E</sub> interface		Backplane RJ45 jack	
No.	Signal	No.	Pin
1	1a	1	4
	1b		5
2	2a	2	4
	2b		5
3	3a	3	4
	3b		5
4	4a	4	4
	4b		5
5	5a	5	4
	5b		5
6	6a	6	4
	6b		5
7	7a	7	4
	7b		5
8	8a	8	4
	8b		5

## Boards

### Description of the Boards

SLCN U <sub>P0/E</sub> interface		Backplane RJ45 jack	
No.	Signal	No.	Pin
9	9a	9	4
	9b		5
10	10a	10	4
	10b		5
11	11a	11	4
	11b		5
12	12a	12	4
	12b		5
13	13a	13	4
	13b		5
14	14a	14	4
	14b		5
15	15a	15	4
	15b		5
16	16a	16	4
	16b		5

### 3.2.28 SLMAV8N, SLMAV24N

The SLMAV8N and SLMAV24N (Subscriber Line Module Analog) boards provide eight (SLMAV8N) and 24 a/b interfaces (SLMAV24N) for connecting analog telephones and devices (fax, modem, etc.).

The SLMAV8N and SLMAV24N boards are compatible successor modules for the following boards, which will be discontinued:

- SLMA (S30810-Q2191-C300)
- SLMA8 (S30810-Q2191-C100)
- SLMA2 (S30810-Q2246-X)

### Board Variants and their Use

Board	Part Number	Used in		Maximum number
		Communication system	Country	
SLMAV8N	S30810-Q2227-X300	OpenScape Business X8	ROW	Is determined by the system-specific capacity limits.
SLMAV24N	S30810-Q2227-X400	OpenScape Business X8	ROW	Is determined by the system-specific capacity limits.

### Main Features

These boards support calling name identification presentation (CLIP).

The SLMAV24N is that only board that supports the connection of external extensions (Off-Premises Stations, OPS).

---

**NOTICE:** For U.S. only: The connection of external extensions via OPS (Off-Premises Station) signaling is not supported.

---



---

#### **NOTICE:** Fire hazard due to surge voltage

In the case of line lengths exceeding 500 m and where the lines exit the building, the SLMAV8N and SLMAV24N boards must be protected by external lightning protection.

Lightning protection of this kind is known as additional primary protection. The additional primary protection is guaranteed by installing ÜSAGs (surge arresters, gas filled) in the main distribution frame, the patch panel or at the entry point of the pipe in the building. A gas-filled surge arrester with 230 V nominal voltage is switched to ground from each wire that is to be protected.

---

The a/b interfaces of the boards supply a ring voltage of 71 V<sub>eff</sub>.

### Front Panel

To ensure sufficient shielding, the front panel of the boards must be provided with a shielding panel.

## Boards

### Description of the Boards

**Figure:** SLMAV8N, SLMAV24N – LEDs on the Front Panel



### LEDs

The boards feature a front panel with two LEDs that indicate the operating states.

**Table:** SLMAV8N, SLMAV24N – LED Statuses and their Meanings

Red LED	Green LED	Meaning	Action
off	off	Board not receiving power or not plugged in correctly. Board is out of order.	Check plug contact on board.
on	off	Board is supplied with power. Board test in progress.	–
		Loadware loading failed. Board is faulty.	Replace board.
		Board was deactivated using Manager E.	Check whether the board was deactivated using Manager E. If not, the board is defective and must be replaced.
flashing	off	Loadware loading in progress.	–
off	on	Loadware loading completed successfully. Board is OK (idle state).	–
off	flashing	At least one channel is activated.	–

### Slots

To ensure optimal ventilation of the base box, the SLMAV8N and SLMAV24N modules must not be placed in slot 7 directly to the right of the OCCL mainboard. Similarly, if possible, no SLMAV8N and SLMAV24N modules should be inserted in slot 5 immediately to the left of the OCCL mainboard.

### Cable and Pin Assignments

There are several connection options for analog telephones and devices (fax, modem, etc.):

- SIVAPAC connectors are available on the backplane for connecting the external main distribution frame MDFU-E or the external patch panel using CABLUs (prefabricated cabling units). See
  - [Table: SLMAV8N – Cable and Pin Assignments \(SIVAPAC Connectors on the Backplane, MDFU-E, Patch Panel\)](#)
  - [Table: SLMAV24N – Cable and Pin Assignments \(SIVAPAC Connectors on the Backplane, MDFU-E, Patch Panel\)](#)
- Connector panels with CHAMP jacks for connecting the external main distribution frame MDFU-E or external patch panels using CABLUs. The connector panels are clipped onto the SIVAPAC connectors on the backplane. See
  - [Table: SLMAV8N – Cable and Pin Assignments \(Connector Panel with CHAMP Jack, MDFU-E, Patch Panel\)](#)
  - [Table: SLMAV24N – Cable and Pin Assignments \(Connector Panel with CHAMP Jack, MDFU-E, Patch Panel\)](#)
- Connector panels with 24 RJ45 jacks for direct connection of analog telephones and devices (fax, modem, etc.). The connector panels are clipped onto the SIVAPAC connectors on the backplane. See
  - [Table: SLMAV8N, SLMAV24N – Pin Assignments \(Connector Panel with 24 RJ45 Jacks\)](#)

**Table:** SLMAV8N – Cable and Pin Assignments (SIVAPAC Connectors on the Backplane, MDFU-E, Patch Panel)

SLMAV8N U <sub>P0/E</sub> interface		Backplane SIVAPAC connector	Connection cable (CABLU)				MDFU-E	Patch Panel RJ45 jack	
No.	Signal	Pin	Color Group	Pair	A-wire	B-wire	Splitting strip	No.	Pin
1	1a	1	1	1	white/blue		1a	1	4
	1b	23				blue/white	1b		5
2	2a	3		2	white/orange		2a	2	4
	2b	4				orange/white	2b		5
3	3a	5		3	white/green		3a	3	4
	3b	6				green/white	3b		5
4	4a	7		4	white/brown		4a	4	4
	4b	8				brown/white	4b		5
5	5a	9		5	white/gray		5a	5	4
	5b	10				gray/white	5b		5

## Boards

### Description of the Boards

SLMAV8N U <sub>P0/E</sub> interface		Backplane SIVAPAC connector	Connection cable (CABLU)				MDFU-E	Patch Panel RJ45 jack	
No.	Signal	Pin	Color Group	Pair	A-wire	B-wire	Splitting strip	No.	Pin
6	6a	11	2	6	red/blue		6a	6	4
	6b	12				blue/red	6b		5
7	7a	13		7	red/orange		7a	7	4
	7b	14				orange/red	7b		5
8	8a	15		8	red/green		8a	8	4
	8b	16				green/red	8b		5
–	–	17		9	red/brown		9a	9	4
	–	18				brown/red	9b		5
–	–	19		10	red/gray		10a	10	4
	–	20				gray/red	10b		5
–	–	24	3	11	black/blue		11a	11	4
	–	25				blue/black	11b		5
–	–	26		12	black/orange		12a	12	4
	–	27				orange/black	12b		5
–	–	29		13	black/green		13a	13	4
	–	30				green/black	13b		5
–	–	31		14	black/brown		14a	14	4
	–	32				brown/black	14b		5
–	–	34		15	black/gray		15a	15	4
	–	35				gray/black	15b		5
–	–	37	4	16	yellow/blue		16a	16	4
	–	38				blue/yellow	16b		5

**Table:** SLMAV24N – Cable and Pin Assignments (SIVAPAC Connectors on the Backplane, MDFU-E, Patch Panel)

SLMAV24N U <sub>P0/E</sub> interface		Backplane SIVAPAC connector	Connection cable (CABLU)				MDFU-E	Patch Panel RJ45 jack		
No.	Signal	Pin	Color Group	Pair	A-wire	B-wire	Jumper strip	No.	Pin	
1	1a	1	1	1	white/blue		1a	1	4	
	1b	23				blue/white	1b		5	
2	2a	3		2	2	white/orange		2a	2	4
	2b	4					orange/white	2b		5
3	3a	5		3	3	white/green		3a	3	4
	3b	6					green/white	3b		5
4	4a	7		4	4	white/brown		4a	4	4
	4b	8					brown/white	4b		5
5	5a	9		5	5	white/gray		5a	5	4
	5b	10					gray/white	5b		5
6	6a	11	2	6	red/blue		6a	6	4	
	6b	12				blue/red	6b		5	
7	7a	13		7	7	red/orange		7a	7	4
	7b	14					orange/red	7b		5
8	8a	15		8	8	red/green		8a	8	4
	8b	16					green/red	8b		5
9	9a	17		9	9	red/brown		9a	9	4
	9b	18					brown/red	9b		5
10	10a	19		10	10	red/gray		10a	10	4
	10b	20					gray/red	10b		5
11	11a	24	3	11	black/blue		11a	11	4	
	11b	25				blue/black	11b		5	
12	12a	26		12	12	black/orange		12a	12	4
	12b	27					orange/black	12b		5
13	13a	29		13	13	black/green		13a	13	4
	13b	30					green/black	13b		5
14	14a	31		14	14	black/brown		14a	14	4
	14b	32					brown/black	14b		5
15	15a	34		15	15	black/gray		15a	15	4
	15b	35					gray/black	15b		5

## Boards

### Description of the Boards

SLMAV24N UP0/E interface		Backplane SIVAPAC connector	Connection cable (CABLU)				MDFU-E	Patch Panel RJ45 jack	
No.	Signal	Pin	Color Group	Pair	A-wire	B-wire	Jumper strip	No.	Pin
16	16a	37	4	16	yellow/blue		16a	16	4
	16b	38				blue/yellow	16b		5
17	17a	43		17	yellow/orange		17a	17	4
	17b	44				orange/yellow	17b		5
18	18a	45		18	yellow/green		18a	18	4
	18b	46				green/yellow	18b		5
19	19a	47		19	yellow/brown		19a	19	4
	19b	48				brown/yellow	19b		5
20	20a	49	20	yellow/gray		20a	20	4	
	20b	50			gray/yellow	20b		5	
21	21a	51	5	21	purple/blue		21a	21	4
	21b	52				blue/purple	21b		5
22	22a	53		22	purple/orange		22a	22	4
	22b	54				orange/purple	22b		5
23	23a	55		23	purple/green		23a	23	4
	23b	56				green/purple	23b		5
24	24a	57		24	purple/brown		24a	24	4
	24b	58				brown/purple	24b		5

**Table:** SLMAV8N – Cable and Pin Assignments (Connector Panel with CHAMP Jack, MDFU-E, Patch Panel)

SLMAV8N UP0/E interface		Backplane CHAMP jack	Connection cable (CABLU)				MDFU-E	Patch Panel RJ45 jack	
No.	Signal	Pin	Color Group	Pair	A-wire	B-wire	Splitting strip	No.	Pin
1	1a	1	1	1	white/blue		1a	1	4
	1b	26				blue/white	1b		5
2	2a	2		2	white/orange		2a	2	4
	2b	27				orange/white	2b		5
3	3a	3		3	white/green		3a	3	4
	3b	28				green/white	3b		5
4	4a	4		4	white/brown		4a	4	4
	4b	29				brown/white	4b		5
5	5a	5	5	white/gray		5a	5	4	
	5b	30			gray/white	5b		5	



SLMAV8N U <sub>P0/E</sub> interface		Backplane CHAMP jack	Connection cable (CABLU)				MDFU-E	Patch Panel RJ45 jack		
No.	Signal	Pin	Color Group	Pair	A-wire	B-wire	Splitting strip	No.	Pin	
6	6a	6	2	6	red/blue		6a	6	4	
	6b	31				blue/red	6b		5	
7	7a	7		7	red/orange		7a	7	4	
	7b	32				orange/red	7b		5	
8	8a	8		8	red/green		8a	8	4	
	8b	33				green/red	8b		5	
-	-	9		9	red/brown		9a	9	4	
	-	34				brown/red	9b		5	
-	-	10		10	red/gray		10a	10	4	
	-	35				gray/red	10b		5	
-	-	11	3	11	black/blue		11a	11	4	
	-	36				blue/black	11b		5	
-	-	12		12	black/orange		12a	12	4	
	-	37				orange/black	12b		5	
-	-	13		13	black/green		13a	13	4	
	-	38				green/black	13b		5	
-	-	14		14	black/brown		14a	14	4	
	-	39				brown/black	14b		5	
-	-	15		15	black/gray		15a	15	4	
	-	40				gray/black	15b		5	
-	-	16		4	16	yellow/blue		16a	16	4
	-	41					blue/yellow	16b		5

## Boards

### Description of the Boards

**Table:** SLMAV24N – Cable and Pin Assignments (Connector Panel with CHAMP Jack, MDFU-E, Patch Panel)

SLMAV24N U <sub>P0/E</sub> interface		Backplane CHAMP jack	Connection cable (CABLU)				MDFU-E	Patch Panel RJ45 jack		
No.	Signal	Pin	Color Group	Pair	A-wire	B-wire	Jumper strip	No.	Pin	
1	1a	1	1	1	white/blue		1a	1	4	
	1b	26				blue/white	1b		5	
2	2a	2		2	white/orange		2a	2	4	
	2b	27				orange/white	2b		5	
3	3a	3		3	white/green		3a	3	4	
	3b	28				green/white	3b		5	
4	4a	4		4	white/brown		4a	4	4	
	4b	29				brown/white	4b		5	
5	5a	5		5	white/gray		5a	5	4	
	5b	30				gray/white	5b		5	
6	6a	6		2	6	red/blue		6a	6	4
	6b	31					blue/red	6b		5
7	7a	7			7	red/orange		7a	7	4
	7b	32					orange/red	7b		5
8	8a	8			8	red/green		8a	8	4
	8b	33				green/red	8b	5		
9	9a	9	9		red/brown		9a	9	4	
	9b	34				brown/red	9b		5	
10	10a	10	10		red/gray		10a	10	4	
	10b	35				gray/red	10b		5	
11	11a	11	3		11	black/blue		11a	11	4
	11b	36					blue/black	11b		5
12	12a	12			12	black/orange		12a	12	4
	12b	37					orange/black	12b		5
13	13a	13			13	black/green		13a	13	4
	13b	38				green/black	13b	5		
14	14a	14		14	black/brown		14a	14	4	
	14b	39				brown/black	14b		5	
15	15a	15		15	black/gray		15a	15	4	
	15b	40				gray/black	15b		5	

SLMAV24N U <sub>P0/E</sub> interface		Backplane CHAMP jack	Connection cable (CABLU)				MDFU-E	Patch Panel RJ45 jack		
No.	Signal	Pin	Color Group	Pair	A-wire	B-wire	Jumper strip	No.	Pin	
16	16a	16	4	16	yellow/blue		16a	16	4	
	16b	41				blue/yellow	16b		5	
17	17a	17		17	yellow/orange		17a	17	4	
	17b	42				orange/yellow	17b		5	
18	18a	18		18	yellow/green		18a	18	4	
	18b	43				green/yellow	18b		5	
19	19a	19		19	yellow/brown		19a	19	4	
	19b	44				brown/yellow	19b		5	
20	20a	20		20	yellow/gray		20a	20	4	
	20b	45				gray/yellow	20b		5	
21	21a	21		5	21	purple/blue		21a	21	4
	21b	46					blue/purple	21b		5
22	22a	22	22		purple/orange		22a	22	4	
	22b	47				orange/purple	22b		5	
23	23a	23	23		purple/green		23a	23	4	
	23b	48				green/purple	23b		5	
24	24a	24	24		purple/brown		24a	24	4	
	24b	49				brown/purple	24b		5	

**Table:** SLMAV8N, SLMAV24N – Pin Assignments (Connector Panel with 24 RJ45 Jacks)

SLMAV8N, SLMAV24N U <sub>P0/E</sub> interface		Backplane RJ45 jack	
No.	Signal	No.	Pin
1	1a	1	4
	1b		5
2	2a	2	4
	2b		5
3	3a	3	4
	3b		5
4	4a	4	4
	4b		5
5	5a	5	4
	5b		5

## Boards

### Description of the Boards

SLMAV8N, SLMAV24N U <sub>P0/E</sub> interface		Backplane RJ45 jack	
No.	Signal	No.	Pin
6	6a	6	4
	6b		5
7	7a	7	4
	7b		5
8	8a	8	4
	8b		5
9 (only SLMAV24N)	9a	9	4
	9b		5
10 (only SLMAV24N)	10a	10	4
	10b		5
11 (only SLMAV24N)	11a	11	4
	11b		5
12 (only SLMAV24N)	12a	12	4
	12b		5
13 (only SLMAV24N)	13a	13	4
	13b		5
14 (only SLMAV24N)	14a	14	4
	14b		5
15 (only SLMAV24N)	15a	15	4
	15b		5
16 (only SLMAV24N)	16a	16	4
	16b		5
17 (only SLMAV24N)	17a	17	4
	17b		5
18 (only SLMAV24N)	18a	18	4
	18b		5
19 (only SLMAV24N)	19a	19	4
	19b		5
20 (only SLMAV24N)	20a	20	4
	20b		5
21 (only SLMAV24N)	21a	21	4
	21b		5

SLMAV8N, SLMAV24N U <sub>P0/E</sub> interface		Backplane RJ45 jack	
No.	Signal	No.	Pin
22 (only SLMAV24N)	22a	22	4
	22b		5
23 (only SLMAV24N)	23a	23	4
	23b		5
24 (only SLMAV24N)	24a	24	4
	24b		5

### 3.2.29 SLMO8N, SLMO24N

The SLMO8N and SLMO24N (Subscriber Line Module Optiset) boards provide 8 (SLMO8N) and 24 U<sub>P0/E</sub> interfaces (SLMO24N) for the connection of U<sub>P0/E</sub> phones (e.g., OpenStage T).

The SLMO8N and SLMO24N boards are compatible successor modules for the following boards, which will be discontinued:

- SLMO8 (S30810-Q2168-X100)
- SLMO2 (S30810-Q2168-X10)
- SLMO24 (S30810-Q2901-X)

#### Board Variants and their Use

Board	Part Number	Used in		Maximum number
		Communication system	Country	
SLMO8N	S30810-Q2168-X300	OpenScape Business X8	ROW	Is determined by the system-specific capacity limits.
SLMO24N	S30810-Q2168-X400	OpenScape Business X8	ROW	Is determined by the system-specific capacity limits.

**NOTICE:** Fire hazard due to surge voltage

In the case of line lengths exceeding 500 m and where the lines exit the building, the SLMO8N and SLMO24N boards must be protected by external lightning protection.

Lightning protection of this kind is known as additional primary protection. The additional primary protection is guaranteed by installing ÜSAGs (surge arresters, gas filled) in the main distribution frame, the patch panel or at the entry point of the pipe

## Boards

### Description of the Boards

in the building. A gas-filled surge arrester with 230 V nominal voltage is switched to ground from each wire that is to be protected.

---

### Front Panel

To ensure sufficient shielding, the front panel of the boards must be provided with a shielding panel.

**Figure:** SLMO8N, SLMO24N – LEDs on the Front Panel



### LEDs

The boards feature a front panel with two LEDs that indicate the operating states.

**Table:** SLMO8N, SLMO24N – LED Statuses and their Meanings

Red LED	Green LED	Meaning	Action
off	off	Board not receiving power or not plugged in correctly. Board is out of order.	Check plug contact on board.
on	off	Board is supplied with power. Board test in progress.	–
		Loadware loading failed. Board is faulty.	Replace board.
		Board was deactivated using Manager E.	Check whether the board was deactivated using Manager E. If not, the board is defective and must be replaced.
flashing	off	Loadware loading in progress.	–
off	on	Loadware loading completed successfully. Board is OK (idle state).	–
off	flashing	At least one channel is activated.	–

### Cable and Pin Assignments

There are several connection options for U<sub>P0/E</sub> phones:

- SIVAPAC connectors are available on the backplane for connecting the external main distribution frame MDFU-E or the external patch panel using CABLUs (prefabricated cabling units). See
  - [Table: SLMO8N – Cable and Pin Assignments \(SIVAPAC Connectors on the Backplane, MDFU-E, Patch Panel\)](#)
  - [Table: SLMO24N – Cable and Pin Assignments \(SIVAPAC Connectors on the Backplane, MDFU-E, Patch Panel\)](#)
- Connector panels with CHAMP jacks for connecting the external main distribution frame MDFU-E or external patch panels using CABLUs. The connector panels are clipped onto the SIVAPAC connectors on the backplane. See
  - [Table: SLMO8N – Cable and Pin Assignments \(Connector Panel with CHAMP Jack, MDFU-E, Patch Panel\)](#)
  - [Table: SLMO24N – Cable and Pin Assignments \(Connector Panel with CHAMP Jack, MDFU-E, Patch Panel\)](#)
- Connector panels with 24 RJ45 jacks for connecting U<sub>P0/E</sub> phones directly. The connector panels are clipped onto the SIVAPAC connectors on the backplane. See
  - [Table: SLMO8N, SLMO24N – Pin Assignments \(Connector Panel with 24 RJ45 Jacks\)](#)

**Table:** SLMO8N – Cable and Pin Assignments (SIVAPAC Connectors on the Backplane, MDFU-E, Patch Panel)

SLMO8N U <sub>P0/E</sub> interface		Backplane SIVAPAC connector	Connection cable (CABLU)				MDFU-E	Patch Panel RJ45 jack	
No.	Signal	Pin	Color Group	Pair	A-wire	B-wire	Splitting strip	No.	Pin
1	1a	1	1	1	white/blue		1a	1	4
	1b	23				blue/white	1b		5
2	2a	3		2	white/orange		2a	2	4
	2b	4				orange/white	2b		5
3	3a	5		3	white/green		3a	3	4
	3b	6				green/white	3b		5
4	4a	7		4	white/brown		4a	4	4
	4b	8				brown/white	4b		5
5	5a	9		5	white/gray		5a	5	4
	5b	10				gray/white	5b		5

## Boards

### Description of the Boards

SLMO8N UP0/E interface		Backplane SIVAPAC connector	Connection cable (CABLU)				MDFU-E	Patch Panel RJ45 jack	
No.	Signal	Pin	Color Group	Pair	A-wire	B-wire	Splitting strip	No.	Pin
6	6a	11	2	6	red/blue		6a	6	4
	6b	12				blue/red	6b		5
7	7a	13		7	red/orange		7a	7	4
	7b	14				orange/red	7b		5
8	8a	15		8	red/green		8a	8	4
	8b	16				green/red	8b		5
-	-	17		9	red/brown		9a	9	4
	-	18				brown/red	9b		5
-	-	19		10	red/gray		10a	10	4
	-	20				gray/red	10b		5
-	-	24	3	11	black/blue		11a	11	4
	-	25				blue/black	11b		5
-	-	26		12	black/orange		12a	12	4
	-	27				orange/black	12b		5
-	-	29		13	black/green		13a	13	4
	-	30				green/black	13b		5
-	-	31		14	black/brown		14a	14	4
	-	32				brown/black	14b		5
-	-	34		15	black/gray		15a	15	4
	-	35				gray/black	15b		5
-	-	37	4	16	yellow/blue		16a	16	4
	-	38				blue/yellow	16b		5



**Table:** SLMO24N – Cable and Pin Assignments (SIVAPAC Connectors on the Backplane, MDFU-E, Patch Panel)

SLMO24N U <sub>P0/E</sub> interface		Backplane SIVAPAC connector	Connection cable (CABLU)				MDFU-E	Patch Panel RJ45 jack		
No.	Signal	Pin	Color Group	Pair	A-wire	B-wire	Jumper strip	No.	Pin	
1	1a	1	1	1	white/blue		1a	1	4	
	1b	23				blue/white	1b		5	
2	2a	3		2	2	white/orange		2a	2	4
	2b	4					orange/white	2b		5
3	3a	5		3	3	white/green		3a	3	4
	3b	6					green/white	3b		5
4	4a	7		4	4	white/brown		4a	4	4
	4b	8					brown/white	4b		5
5	5a	9		5	5	white/gray		5a	5	4
	5b	10					gray/white	5b		5
6	6a	11	2	6	red/blue		6a	6	4	
	6b	12				blue/red	6b		5	
7	7a	13		7	7	red/orange		7a	7	4
	7b	14					orange/red	7b		5
8	8a	15		8	8	red/green		8a	8	4
	8b	16					green/red	8b		5
9	9a	17		9	9	red/brown		9a	9	4
	9b	18					brown/red	9b		5
10	10a	19		10	10	red/gray		10a	10	4
	10b	20					gray/red	10b		5
11	11a	24	3	11	black/blue		11a	11	4	
	11b	25				blue/black	11b		5	
12	12a	26		12	12	black/orange		12a	12	4
	12b	27					orange/black	12b		5
13	13a	29		13	13	black/green		13a	13	4
	13b	30					green/black	13b		5
14	14a	31		14	14	black/brown		14a	14	4
	14b	32					brown/black	14b		5
15	15a	34		15	15	black/gray		15a	15	4
	15b	35					gray/black	15b		5

## Boards

### Description of the Boards

SLMO24N UP0/E interface		Backplane SIVAPAC connector	Connection cable (CABLU)				MDFU-E	Patch Panel RJ45 jack	
No.	Signal	Pin	Color Group	Pair	A-wire	B-wire	Jumper strip	No.	Pin
16	16a	37	4	16	yellow/blue		16a	16	4
	16b	38				blue/yellow	16b		5
17	17a	43		17	yellow/orange		17a	17	4
	17b	44				orange/yellow	17b		5
18	18a	45		18	yellow/green		18a	18	4
	18b	46				green/yellow	18b		5
19	19a	47		19	yellow/brown		19a	19	4
	19b	48				brown/yellow	19b		5
20	20a	49	20	yellow/gray		20a	20	4	
	20b	50			gray/yellow	20b		5	
21	21a	51	5	21	purple/blue		21a	21	4
	21b	52				blue/purple	21b		5
22	22a	53		22	purple/orange		22a	22	4
	22b	54				orange/purple	22b		5
23	23a	55		23	purple/green		23a	23	4
	23b	56				green/purple	23b		5
24	24a	57		24	purple/brown		24a	24	4
	24b	58				brown/purple	24b		5

**Table:** SLMO8N – Cable and Pin Assignments (Connector Panel with CHAMP Jack, MDFU-E, Patch Panel)

SLMO8N UP0/E interface		Backplane CHAMP jack	Connection cable (CABLU)				MDFU-E	Patch Panel RJ45 jack	
No.	Signal	Pin	Color Group	Pair	A-wire	B-wire	Splitting strip	No.	Pin
1	1a	1	1	1	white/blue		1a	1	4
	1b	26				blue/white	1b		5
2	2a	2		2	white/orange		2a	2	4
	2b	27				orange/white	2b		5
3	3a	3		3	white/green		3a	3	4
	3b	28				green/white	3b		5
4	4a	4		4	white/brown		4a	4	4
	4b	29				brown/white	4b		5
5	5a	5		5	white/gray		5a	5	4
	5b	30				gray/white	5b		5

SLMO8N U <sub>P0/E</sub> interface		Backplane CHAMP jack	Connection cable (CABLU)				MDFU-E	Patch Panel RJ45 jack		
No.	Signal	Pin	Color Group	Pair	A-wire	B-wire	Splitting strip	No.	Pin	
6	6a	6	2	6	red/blue		6a	6	4	
	6b	31				blue/red	6b		5	
7	7a	7		7	red/orange		7a	7	4	
	7b	32				orange/red	7b		5	
8	8a	8		8	red/green		8a	8	4	
	8b	33				green/red	8b		5	
-	-	9		9	red/brown		9a	9	4	
	-	34				brown/red	9b		5	
-	-	10		10	red/gray		10a	10	4	
	-	35				gray/red	10b		5	
-	-	11	3	11	black/blue		11a	11	4	
	-	36				blue/black	11b		5	
-	-	12		12	black/orange		12a	12	4	
	-	37				orange/black	12b		5	
-	-	13		13	black/green		13a	13	4	
	-	38				green/black	13b		5	
-	-	14		14	black/brown		14a	14	4	
	-	39				brown/black	14b		5	
-	-	15		15	black/gray		15a	15	4	
	-	40				gray/black	15b		5	
-	-	16		4	16	yellow/blue		16a	16	4
	-	41					blue/yellow	16b		5

## Boards

### Description of the Boards

**Table:** SLMO24N – Cable and Pin Assignments (Connector Panel with CHAMP Jack, MDFU-E, Patch Panel)

SLMO24N U <sub>P0/E</sub> interface		Backplane CHAMP jack	Connection cable (CABLU)				MDFU-E	Patch Panel RJ45 jack		
No.	Signal	Pin	Color Group	Pair	A-wire	B-wire	Jumper strip	No.	Pin	
1	1a	1	1	1	white/blue		1a	1	4	
	1b	26				blue/white	1b		5	
2	2a	2		2	white/orange		2a	2	4	
	2b	27				orange/white	2b		5	
3	3a	3		3	white/green		3a	3	4	
	3b	28				green/white	3b		5	
4	4a	4		4	white/brown		4a	4	4	
	4b	29				brown/white	4b		5	
5	5a	5		5	white/gray		5a	5	4	
	5b	30				gray/white	5b		5	
6	6a	6		2	6	red/blue		6a	6	4
	6b	31					blue/red	6b		5
7	7a	7			7	red/orange		7a	7	4
	7b	32					orange/red	7b		5
8	8a	8			8	red/green		8a	8	4
	8b	33				green/red	8b	5		
9	9a	9	9		red/brown		9a	9	4	
	9b	34				brown/red	9b		5	
10	10a	10	10		red/gray		10a	10	4	
	10b	35				gray/red	10b		5	
11	11a	11	3		11	black/blue		11a	11	4
	11b	36					blue/black	11b		5
12	12a	12			12	black/orange		12a	12	4
	12b	37					orange/black	12b		5
13	13a	13			13	black/green		13a	13	4
	13b	38				green/black	13b	5		
14	14a	14		14	black/brown		14a	14	4	
	14b	39				brown/black	14b		5	
15	15a	15		15	black/gray		15a	15	4	
	15b	40				gray/black	15b		5	

SLMO24N U <sub>P0/E</sub> interface		Backplane CHAMP jack	Connection cable (CABLU)				MDFU-E	Patch Panel RJ45 jack		
No.	Signal	Pin	Color Group	Pair	A-wire	B-wire	Jumper strip	No.	Pin	
16	16a	16	4	16	yellow/blue		16a	16	4	
	16b	41				blue/yellow	16b		5	
17	17a	17		17	yellow/orange		17a	17	4	
	17b	42				orange/yellow	17b		5	
18	18a	18		18	yellow/green		18a	18	4	
	18b	43				green/yellow	18b		5	
19	19a	19		19	yellow/brown		19a	19	4	
	19b	44				brown/yellow	19b		5	
20	20a	20		20	yellow/gray		20a	20	4	
	20b	45				gray/yellow	20b		5	
21	21a	21		5	21	purple/blue		21a	21	4
	21b	46					blue/purple	21b		5
22	22a	22	22		purple/orange		22a	22	4	
	22b	47				orange/purple	22b		5	
23	23a	23	23		purple/green		23a	23	4	
	23b	48				green/purple	23b		5	
24	24a	24	24		purple/brown		24a	24	4	
	24b	49				brown/purple	24b		5	

**Table:** SLMO8N, SLMO24N – Pin Assignments (Connector Panel with 24 RJ45 Jacks)

SLMO8N, SLMO24N U <sub>P0/E</sub> interface		Backplane RJ45 jack	
No.	Signal	No.	Pin
1	1a	1	4
	1b		5
2	2a	2	4
	2b		5
3	3a	3	4
	3b		5
4	4a	4	4
	4b		5
5	5a	5	4
	5b		5

## Boards

### Description of the Boards

SLMO8N, SLMO24N U <sub>P0/E</sub> interface		Backplane RJ45 jack	
No.	Signal	No.	Pin
6	6a	6	4
	6b		5
7	7a	7	4
	7b		5
8	8a	8	4
	8b		5
9 (only SLMO24N)	9a	9	4
	9b		5
10 (only SLMO24N)	10a	10	4
	10b		5
11 (only SLMO24N)	11a	11	4
	11b		5
12 (only SLMO24N)	12a	12	4
	12b		5
13 (only SLMO24N)	13a	13	4
	13b		5
14 (only SLMO24N)	14a	14	4
	14b		5
15 (only SLMO24N)	15a	15	4
	15b		5
16 (only SLMO24N)	16a	16	4
	16b		5
17 (only SLMO24N)	17a	17	4
	17b		5
18 (only SLMO24N)	18a	18	4
	18b		5
19 (only SLMO24N)	19a	19	4
	19b		5
20 (only SLMO24N)	20a	20	4
	20b		5
21 (only SLMO24N)	21a	21	4
	21b		5

SLMO8N, SLMO24N U <sub>P0/E</sub> interface		Backplane RJ45 jack	
No.	Signal	No.	Pin
22 (only SLMO24N)	22a	22	4
	22b		5
23 (only SLMO24N)	23a	23	4
	23b		5
24 (only SLMO24N)	24a	24	4
	24b		5

### 3.2.30 SLMU

The SLMU (Subscriber Line Module U<sub>P0</sub>) board provides 24 U<sub>P0/E</sub> interfaces for the connection of U<sub>P0/E</sub> phones (e.g., OpenStage T).

#### Board Variants and their Use

Board	Part Number	Used in		Maximum number
		Communication system	Country	
SLMU	S30810-Q2344-X100	OpenScape Business X8	ROW	Is determined by the system-specific capacity limits.

---

**NOTICE:** Fire hazard due to surge voltage.

In the case of line lengths exceeding 500 m and where the lines exit the building, the SLMU board must be protected by external lightning protection.

Lightning protection of this kind is known as additional primary protection. The additional primary protection is guaranteed by installing ÜSAGs (surge arresters, gas filled) in the main distribution frame, the patch panel or at the entry point of the pipe in the building. A gas-filled surge arrester with 230 V nominal voltage is switched to ground from each wire that is to be protected

---

#### Front Panel

To ensure sufficient shielding, the front panel of the boards must be provided with a shielding panel.

**Figure:** SLMU – LEDs on the Front Panel



**LEDs**

The boards feature a front panel with two LEDs that indicate the operating states.

**Table:** SLMU – LED Statuses and their Meanings

Red LED	Green LED	Meaning	Action
off	off	Board not receiving power or not plugged in correctly. Board is out of order.	Check plug contact on board.
on	off	Board is supplied with power. Board test in progress.	–
		Loadware loading failed. Board is faulty.	Replace board.
		Board was deactivated using Manager E.	Check whether the board was deactivated using Manager E. If not, the board is defective and must be replaced.
flashing	off	Loadware loading in progress.	–
off	on	Loadware loading completed successfully. Board is OK (idle state).	–
off	flashing	At least one channel is activated.	–

**Cable and Pin Assignments**

There are several connection options for U<sub>P0/E</sub> phones:

- SIVAPAC connectors are available on the backplane for connecting the external main distribution frame MDFU-E or the external patch panel using CABLUs (prefabricated cabling units). See
  - SLMU – Cable and Pin Assignments (SIVAPAC Connectors on the Backplane, MDFU-E, Patch Panel)



- Connector panels with CHAMP jacks for connecting the external main distribution frame MDFU-E or external patch panels using CABLUs. The connector panels are clipped onto the SIVAPAC connectors on the backplane. See
  - SLMU – Cable and Pin Assignments (Connector Panel with CHAMP Jack, MDFU-E, Patch Panel)

**Table:** SLMU – Cable and Pin Assignments (SIVAPAC Connectors on the Backplane, MDFU-E, Patch Panel)

SLMU U <sub>P0/E</sub> interface		Backplane SIVAPAC connector	Connection cable (CABLU)				MDFU-E	Patch Panel RJ45 jack	
No.	Signal	Pin	Color Group	Pair	A-wire	B-wire	Jumper strip	No.	Pin
1	1a	1	1	1	white/blue		1a	1	4
	1b	23				blue/white	1b		5
2	2a	3		2	white/orange		2a	2	4
	2b	4				orange/white	2b		5
3	3a	5		3	white/green		3a	3	4
	3b	6				green/white	3b		5
4	4a	7		4	white/brown		4a	4	4
	4b	8				brown/white	4b		5
5	5a	9		5	white/gray		5a	5	4
	5b	10				gray/white	5b		5
6	6a	11	2	6	red/blue		6a	6	4
	6b	12				blue/red	6b		5
7	7a	13		7	red/orange		7a	7	4
	7b	14				orange/red	7b		5
8	8a	15		8	red/green		8a	8	4
	8b	16				green/red	8b		5
9	9a	17		9	red/brown		9a	9	4
	9b	18				brown/red	9b		5
10	10a	19		10	red/gray		10a	10	4
	10b	20				gray/red	10b		5

## Boards

### Description of the Boards

SLMU U <sub>P0/E</sub> interface		Backplane SIVAPAC connector	Connection cable (CABLU)				MDFU-E	Patch Panel RJ45 jack	
No.	Signal	Pin	Color Group	Pair	A-wire	B-wire	Jumper strip	No.	Pin
11	11a	24	3	11	black/blue		11a	11	4
	11b	25				blue/black	11b		5
12	12a	26		12	black/orange		12a	12	4
	12b	27				orange/black	12b		5
13	13a	29		13	black/green		13a	13	4
	13b	30				green/black	13b		5
14	14a	31		14	black/brown		14a	14	4
	14b	32				brown/black	14b		5
15	15a	34		15	black/gray		15a	15	4
	15b	35				gray/black	15b		5
16	16a	37	4	16	yellow/blue		16a	16	4
	16b	38				blue/yellow	16b		5
17	17a	43		17	yellow/orange		17a	17	4
	17b	44				orange/yellow	17b		5
18	18a	45		18	yellow/green		18a	18	4
	18b	46				green/yellow	18b		5
19	19a	47		19	yellow/brown		19a	19	4
	19b	48				brown/yellow	19b		5
20	20a	49		20	yellow/gray		20a	20	4
	20b	50				gray/yellow	20b		5
21	21a	51	5	21	purple/blue		21a	21	4
	21b	52				blue/purple	21b		5
22	22a	53		22	purple/orange		22a	22	4
	22b	54				orange/purple	22b		5
23	23a	55		23	purple/green		23a	23	4
	23b	56				green/purple	23b		5
24	24a	57		24	purple/brown		24a	24	4
	24b	58				brown/purple	24b		5

**Table:** SLMU – Cable and Pin Assignments (Connector Panel with CHAMP Jack, MDFU-E, Patch Panel)

SLMU U <sub>P0/E</sub> interface		Backplane CHAMP jack	Connection cable (CABLU)				MDFU-E	Patch Panel RJ45 jack					
No.	Signal	Pin	Color Group	Pair	A-wire	B-wire	Jumper strip	No.	Pin				
1	1a	1	1	1	white/blue		1a	1	4				
	1b	26				blue/white	1b		5				
2	2a	2		1	2	white/orange		2a	2	4			
	2b	27					orange/white	2b		5			
3	3a	3			1	3	white/green		3a	3	4		
	3b	28						green/white	3b		5		
4	4a	4				1	4	white/brown		4a	4	4	
	4b	29							brown/white	4b		5	
5	5a	5					1	5	white/gray		5a	5	4
	5b	30								gray/white	5b		5
6	6a	6	2					6	red/blue		6a	6	4
	6b	31								blue/red	6b		5
7	7a	7		2				7	red/orange		7a	7	4
	7b	32								orange/red	7b		5
8	8a	8			2			8	red/green		8a	8	4
	8b	33								green/red	8b		5
9	9a	9				2		9	red/brown		9a	9	4
	9b	34								brown/red	9b		5
10	10a	10					2	10	red/gray		10a	10	4
	10b	35								gray/red	10b		5
11	11a	11	3					11	black/blue		11a	11	4
	11b	36								blue/black	11b		5
12	12a	12		3				12	black/orange		12a	12	4
	12b	37								orange/black	12b		5
13	13a	13			3			13	black/green		13a	13	4
	13b	38								green/black	13b		5
14	14a	14				3		14	black/brown		14a	14	4
	14b	39								brown/black	14b		5
15	15a	15					3	15	black/gray		15a	15	4
	15b	40								gray/black	15b		5

## Boards

### Description of the Boards

SLMU U <sub>P0/E</sub> interface		Backplane CHAMP jack	Connection cable (CABLU)				MDFU-E	Patch Panel RJ45 jack		
No.	Signal	Pin	Color Group	Pair	A-wire	B-wire	Jumper strip	No.	Pin	
16	16a	16	4	16	yellow/blue		16a	16	4	
	16b	41				blue/yellow	16b		5	
17	17a	17		17	yellow/orange		17a	17	4	
	17b	42				orange/yellow	17b		5	
18	18a	18		18	yellow/green		18a	18	4	
	18b	43				green/yellow	18b		5	
19	19a	19		19	yellow/brown		19a	19	4	
	19b	44				brown/yellow	19b		5	
20	20a	20		20	yellow/gray		20a	20	4	
	20b	45				gray/yellow	20b		5	
21	21a	21		5	21	purple/blue		21a	21	4
	21b	46					blue/purple	21b		5
22	22a	22	22		purple/orange		22a	22	4	
	22b	47				orange/purple	22b		5	
23	23a	23	23		purple/green		23a	23	4	
	23b	48				green/purple	23b		5	
24	24a	24	24		purple/brown		24a	24	4	
	24b	49				brown/purple	24b		5	

**Table:** SLMU – Pin Assignments (Connector Panel with 24 RJ45 Jacks)

SLMU U <sub>P0/E</sub> interface		Backplane RJ45 jack	
No.	Signal	No.	Pin
1	1a	1	4
	1b		5
2	2a	2	4
	2b		5
3	3a	3	4
	3b		5
4	4a	4	4
	4b		5
5	5a	5	4
	5b		5

SLMU U <sub>P0/E</sub> interface		Backplane RJ45 jack	
No.	Signal	No.	Pin
6	6a	6	4
	6b		5
7	7a	7	4
	7b		5
8	8a	8	4
	8b		5
9	9a	9	4
	9b		5
10	10a	10	4
	10b		5
11	11a	11	4
	11b		5
12	12a	12	4
	12b		5
13	13a	13	4
	13b		5
14	14a	14	4
	14b		5
15	15a	15	4
	15b		5
16	16a	16	4
	16b		5
17	17a	17	4
	17b		5
18	18a	18	4
	18b		5
19	19a	19	4
	19b		5
20	20a	20	4
	20b		5
21	21a	21	4
	21b		5

## Boards

### Description of the Boards

SLMU U <sub>P0/E</sub> interface		Backplane RJ45 jack	
No.	Signal	No.	Pin
22	22a	22	4
	22b		5
23	23a	23	4
	23b		5
24	24a	24	4
	24b		5

### 3.2.31 SLMUC

The SLMUC board is the combination of an SLMU board and a CMAe card and provides 24 U<sub>P0/E</sub> interfaces for connecting DECT base stations to the integrated cordless solution.

For information on the installation and connection of DECT base stations, see [Integrated Cordless Solution](#).

#### Board Variants and their Use

Board	Part Number	Used in		Maximum number
		Communication system	Country	
SLMU	S30810-Q2344-X100	OpenScape Business X8	ROW (not for U.S.)	Is determined by the systemspecific capacity limits
CMAe	S30807-Q6957-X	OpenScape Business X8	ROW (not for U.S.)	Is determined by the systemspecific capacity limits

**INFO:** To guarantee uninterrupted operation of OpenScape Business X8, no more than two SLMUC boards should be plugged into any of the PCM segments. For information on the

distribution of the PCM highways, please refer to the *OpenScape Business X3/X5/X8, Installation Guide*

One slot should be kept free between two SLMUC boards to prevent overheating.

When the new SLMUC card is inserted it will start being loaded into the system and since it doesn't know of any other running cards this could lead to a reboot of the other SLMUC cards.

This installation procedure might cause DECT functionality to be out of service temporarily.

---

**NOTICE:** Fire hazard due to surge voltage

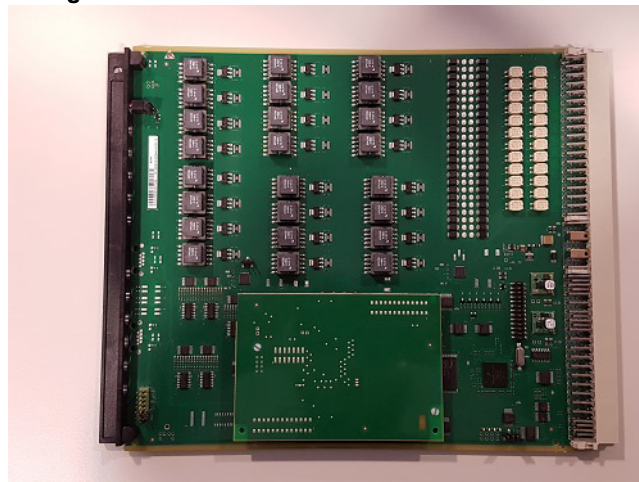
In the case of line lengths exceeding 500 m and where the lines exit the building, the SLMUC board must be protected by external lightning protection.

Lightning protection of this kind is known as additional primary protection. The additional primary protection is guaranteed by installing ÜSAGs (surge arresters, gas filled) in the main distribution frame, the patch panel or at the entry point of the pipe in the building. A gas-filled surge arrester with 230 V nominal voltage is switched to ground from each wire that is to be protected.

---

As soon as a CMAe module is connected to the SLMU card this card will act for CMI only.

**Figure:** SLMUC



Base Stations can be connected to the Interfaces 1 to 16 only. Interfaces 17 to 24 can be used for additional B-channels only to extend the number of B-Channel. This can be done without any administration, it will be recognized automatically.

Each SLMU card in the system needs a CMAe module to work for CMI. As long as the CMAe module is not connected the card will work for U<sub>P0</sub> Phones only.

## Boards

### Description of the Boards

#### Front Panel

To ensure sufficient shielding, the front panel of the boards must be provided with a shielding panel.

**Figure:** SLMU – LEDs on the Front Panel



#### LEDs

The boards feature a front panel with two LEDs that indicate the operating states.

**Table:** SLMUC – LED Statuses and their Meanings

Red LED	Green LED	Meaning	Action
off	off	Board not receiving power or not plugged in correctly. Board is out of order.	Check plug contact on board.
on	off	Board is supplied with power. Board test in progress.	–
		Loadware loading failed. Board is faulty.	Replace board.
		Board was deactivated using Manager E.	Check whether the board was deactivated using Manager E. If not, the board is defective and must be replaced.
flashing	off	Loadware loading in progress.	–
off	on	Loadware loading completed successfully. Board is OK (idle state).	–
off	flashing	At least one channel is activated.	–

#### Cable and Pin Assignments

There are several connection options for base stations:



- SIVAPAC connectors are available on the backplane for connecting the external main distribution frame MDFU-E or the external patch panel using CABLUs (prefabricated cabling units).
- Connector panels with CHAMP jacks for connecting the external main distribution frame MDFU-E or external patch panels using CABLUs. The connector panels are clipped onto the SIVAPAC connectors on the backplane.

**Table:** SLMUC – Cable and Pin Assignments (SIVAPAC Connectors on the Backplane, MDFU-E, Patch Panel)

SLMUC U <sub>P0/E</sub> interface		Backplane SIVAPAC connector	Connection cable (CABLU)				MDFU-E	Patch Panel RJ45 jack	
No.	Signal	Pin	Color Group	Pair	A-wire	B-wire	Jumper strip	No.	Pin
1	1a	1	1	1	white/blue		1a	1	4
	1b	23				blue/white	1b		5
2	2a	3		2	white/orange		2a	2	4
	2b	4				orange/white	2b		5
3	3a	5		3	white/green		3a	3	4
	3b	6				green/white	3b		5
4	4a	7		4	white/brown		4a	4	4
	4b	8				brown/white	4b		5
5	5a	9		5	white/gray		5a	5	4
	5b	10				gray/white	5b		5
6	6a	11	2	6	red/blue		6a	6	4
	6b	12				blue/red	6b		5
7	7a	13		7	red/orange		7a	7	4
	7b	14				orange/red	7b		5
8	8a	15		8	red/green		8a	8	4
	8b	16				green/red	8b		5
9	9a	17		9	red/brown		9a	9	4
	9b	18				brown/red	9b		5
10	10a	19		10	red/gray		10a	10	4
	10b	20				gray/red	10b		5

## Boards

### Description of the Boards

SLMUC U <sub>P0/E</sub> interface		Backplane SIVAPAC connector	Connection cable (CABLU)				MDFU-E	Patch Panel RJ45 jack	
No.	Signal	Pin	Color Group	Pair	A-wire	B-wire	Jumper strip	No.	Pin
11	11a	24	3	11	black/blue		11a	11	4
	11b	25				blue/black	11b		5
12	12a	26		12	black/orange		12a	12	4
	12b	27				orange/black	12b		5
13	13a	29		13	black/green		13a	13	4
	13b	30				green/black	13b		5
14	14a	31		14	black/brown		14a	14	4
	14b	32				brown/black	14b		5
15	15a	34		15	black/gray		15a	15	4
	15b	35				gray/black	15b		5
16	16a	37	4	16	yellow/blue		16a	16	4
	16b	38				blue/yellow	16b		5
17	17a	43		17	yellow/orange		17a	17	4
	17b	44				orange/yellow	17b		5
18	18a	45		18	yellow/green		18a	18	4
	18b	46				green/yellow	18b		5
19	19a	47		19	yellow/brown		19a	19	4
	19b	48				brown/yellow	19b		5
20	20a	49		20	yellow/gray		20a	20	4
	20b	50				gray/yellow	20b		5
21	21a	51	5	21	purple/blue		21a	21	4
	21b	52				blue/purple	21b		5
22	22a	53		22	purple/orange		22a	22	4
	22b	54				orange/purple	22b		5
23	23a	55		23	purple/green		23a	23	4
	23b	56				green/purple	23b		5
24	24a	57		24	purple/brown		24a	24	4
	24b	58				brown/purple	24b		5

**Table:** SLMUC – Cable and Pin Assignments (Connector Panel with CHAMP Jack, MDFU-E, Patch Panel)

SLMUC U <sub>P0/E</sub> interface		Backplane CHAMP jack	Connection cable (CABLU)				MDFU-E	Patch Panel RJ45 jack					
No.	Signal	Pin	Color Group	Pair	A-wire	B-wire	Jumper strip	No.	Pin				
1	1a	1	1	1	white/blue		1a	1	4				
	1b	26				blue/white	1b		5				
2	2a	2		1	2	white/orange		2a	2	4			
	2b	27					orange/white	2b		5			
3	3a	3			1	3	white/green		3a	3	4		
	3b	28						green/white	3b		5		
4	4a	4				1	4	white/brown		4a	4	4	
	4b	29							brown/white	4b		5	
5	5a	5					1	5	white/gray		5a	5	4
	5b	30								gray/white	5b		5
6	6a	6	2					6	red/blue		6a	6	4
	6b	31								blue/red	6b		5
7	7a	7		2				7	red/orange		7a	7	4
	7b	32								orange/red	7b		5
8	8a	8			2			8	red/green		8a	8	4
	8b	33								green/red	8b		5
9	9a	9				2		9	red/brown		9a	9	4
	9b	34								brown/red	9b		5
10	10a	10					2	10	red/gray		10a	10	4
	10b	35								gray/red	10b		5
11	11a	11	3					11	black/blue		11a	11	4
	11b	36								blue/black	11b		5
12	12a	12		3				12	black/orange		12a	12	4
	12b	37								orange/black	12b		5
13	13a	13			3			13	black/green		13a	13	4
	13b	38								green/black	13b		5
14	14a	14				3		14	black/brown		14a	14	4
	14b	39								brown/black	14b		5
15	15a	15					3	15	black/gray		15a	15	4
	15b	40								gray/black	15b		5

## Boards

### Description of the Boards

SLMUC U <sub>P0/E</sub> interface		Backplane CHAMP jack	Connection cable (CABLU)				MDFU-E	Patch Panel RJ45 jack		
No.	Signal	Pin	Color Group	Pair	A-wire	B-wire	Jumper strip	No.	Pin	
16	16a	16	4	16	yellow/blue		16a	16	4	
	16b	41				blue/yellow	16b		5	
17	17a	17		17	yellow/orange		17a	17	4	
	17b	42				orange/yellow	17b		5	
18	18a	18		18	yellow/green		18a	18	4	
	18b	43				green/yellow	18b		5	
19	19a	19		19	yellow/brown		19a	19	4	
	19b	44				brown/yellow	19b		5	
20	20a	20		20	yellow/gray		20a	20	4	
	20b	45				gray/yellow	20b		5	
21	21a	21		5	21	purple/blue		21a	21	4
	21b	46					blue/purple	21b		5
22	22a	22	22		purple/orange		22a	22	4	
	22b	47				orange/purple	22b		5	
23	23a	23	23		purple/green		23a	23	4	
	23b	48				green/purple	23b		5	
24	24a	24	24		purple/brown		24a	24	4	
	24b	49				brown/purple	24b		5	

**Table:** SLMUC – Pin Assignments (Connector Panel with 24 RJ45 Jacks)

SLMUC U <sub>P0/E</sub> interface		Backplane RJ45 jack	
No.	Signal	No.	Pin
1	1a	1	4
	1b		5
2	2a	2	4
	2b		5
3	3a	3	4
	3b		5
4	4a	4	4
	4b		5
5	5a	5	4
	5b		5

SLMUC U <sub>P0/E</sub> interface		Backplane RJ45 jack	
No.	Signal	No.	Pin
6	6a	6	4
	6b		5
7	7a	7	4
	7b		5
8	8a	8	4
	8b		5
9	9a	9	4
	9b		5
10	10a	10	4
	10b		5
11	11a	11	4
	11b		5
12	12a	12	4
	12b		5
13	13a	13	4
	13b		5
14	14a	14	4
	14b		5
15	15a	15	4
	15b		5
16	16a	16	4
	16b		5
17	17a	17	4
	17b		5
18	18a	18	4
	18b		5
19	19a	19	4
	19b		5
20	20a	20	4
	20b		5
21	21a	21	4
	21b		5

## Boards

### Description of the Boards

SLMUC U <sub>P0/E</sub> interface		Backplane RJ45 jack	
No.	Signal	No.	Pin
22	22a	22	4
	22b		5
23	23a	23	4
	23b		5
24	24a	24	4
	24b		5

### 3.2.32 SLU8N, SLU8NR

The SLU8N and SLU8NR (Subscriber Line U<sub>P0/E</sub>, New, Rack) boards provide eight U<sub>P0/E</sub> interfaces for connecting U<sub>P0/E</sub> telephones (e.g., OpenStage T).

The SLU8N and SLU8NR boards are compatible successor modules for the following boards, which will be discontinued:

- SLU8 (S30817-Q922-A301)
- SLU8R (S30817-K922-Z301)

#### Board Variants and their Use

Board	Part Number	Used in		Maximum number
		Communication system	Country	
SLU8N	S30817-Q922-A401	OpenScape Business X3W	ROW	2
		OpenScape Business X5W		Is determined by the system-specific capacity limits.
SLU8NR	S30817-K922-Z401	OpenScape Business X3R	ROW	2
		OpenScape Business X5R		Is determined by the system-specific capacity limits.

---

**NOTICE:** Fire hazard due to surge voltage

In the case of line lengths exceeding 500 m and where the lines exit the building, the SLU8N and SLU8NR boards must be protected by external lightning protection.

Lightning protection of this kind is known as additional primary protection. The additional primary protection is guaranteed by installing ÜSAGs (surge arresters, gas filled) in the main distribution frame, the patch panel or at the entry point of the pipe in the building. A gas-filled surge arrester with 230 V nominal voltage is switched to ground from each wire that is to be protected.

---



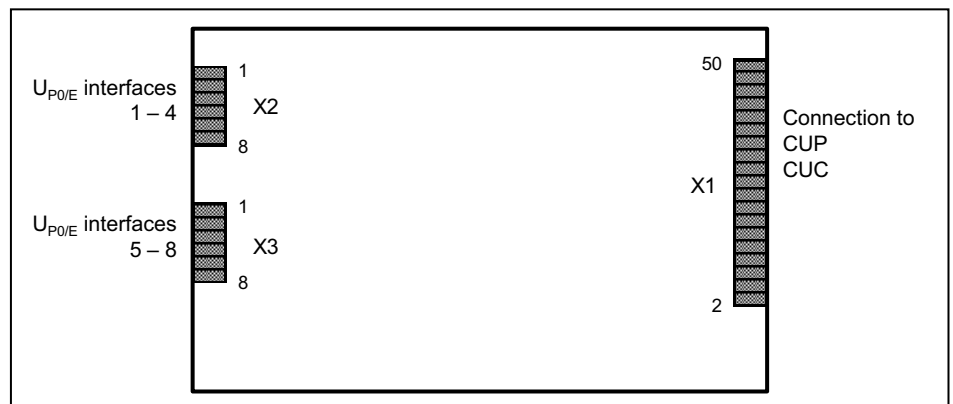
---

**INFO:** SLU8N is not supported by Manager E.

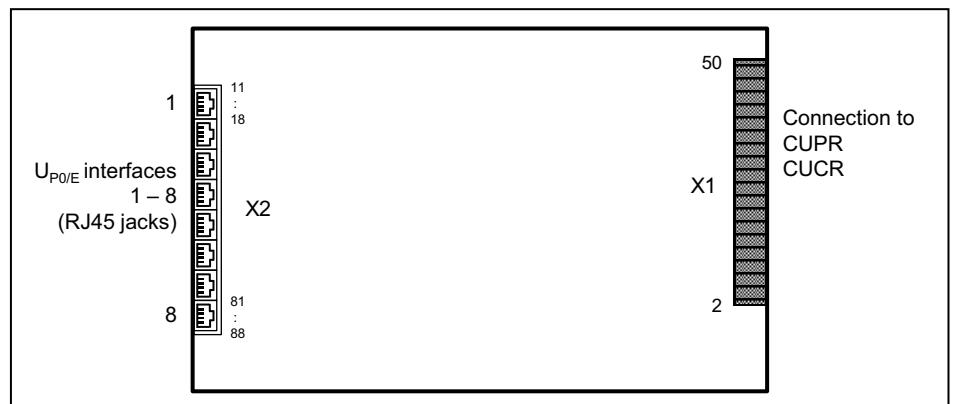
---

**Figure**

**Figure:** SLU8N



**Figure:** SLU8NR



### Pin Assignments

**Table:** SLU8N - Pin Assignments

X2		X3	
Pin	U <sub>P0/E</sub> interfaces 1 – 4	Pin	U <sub>P0/E</sub> interfaces 5 – 8
1	a 1	1	a 5
2	b 1	2	b 5
3	a 2	3	a 6
4	b 2	4	b 6
5	a 3	5	a 7
6	b 3	6	b 7
7	a 4	7	a 8
8	b 4	8	b 8

**Table:** SLU8NR - Pin Assignments

RJ45 jack	Pin	U <sub>P0/E</sub> interfaces 1 – 8
1	14	a 1
	15	b 1
2	24	a 2
	25	b 2
3	34	a 3
	35	b 3
4	44	a 4
	45	b 4
5	54	a 5
	55	b 5
6	64	a 6
	65	b 6
7	74	a 7
	75	b 7
8	84	a 8
	85	b 8

The RJ45 jacks each have two wires.

### 3.2.33 STLSX2, STLSX4, STLSX4R

The STLSX2, STLSX4 and STLSX4R (Subscriber Trunk Line S<sub>0</sub> with ISAC-SX, rack) boards provide two (STLSX2) and four (STLSX8, STLSX0R) S<sub>0</sub> interfaces



which can be used for the ISDN trunk connection, tie-traffic (networking) or ISDN station connections (ISDN phones, Fax Group 4, etc.).

The STLSX2, STLSX4 and STLSX4R boards are compatible successor modules for the following boards, which will be discontinued:

- STLS2 (S30817-Q924-B313)
- STLS4 (S30817-Q924-A313)
- STLS4R (S30817-Q924-Z313)

**Board Variants and their Use**

Board	Part Number	Used in		Maximum number
		Communication system	Country	
STLSX2	S30810-H2944-X100	OpenScape Business X3W	ROW	2
		OpenScape Business X5W		Is determined by the system-specific capacity limits.
STLSX4	S30810-H2944-X	OpenScape Business X3W	ROW	2
		OpenScape Business X5W		Is determined by the system-specific capacity limits.
STLSX4R	S30810-K2944-Z	OpenScape Business X3R	ROW	2
		OpenScape Business X5R		Is determined by the system-specific capacity limits.

**Usage Types**

The setting of the usage type for each interface occurs via the WBM:

- ISDN trunk connection: point-to-point connection or point-to-multipoint connection
- ISDN station connection: internal S<sub>0</sub> port

The connected ISDN phones cannot be adequately supplied with power. A local power supply (e.g., plug-in power supply) is required.

For STLSX4R only: The RJ45 jacks on the S<sub>0</sub> ports each have four wires. ISDN trunk lines can be directly connected (1:1 cable). For ISDN phones, the Receive and Transmit lines must be swapped in each case.

## Boards

### Description of the Boards

---

**NOTICE:** Fire hazard due to surge voltage

Only for the  $S_0$  interfaces used for the station connection: In the case of line lengths exceeding 500 m and where the lines need to exit the building, the STLSX2, STLSX4 and STLSX4R boards must be protected by external lightning protection.

Lightning protection of this kind is known as additional primary protection. The additional primary protection is guaranteed by installing ÜSAGs (surge arresters, gas filled) in the main distribution frame, the patch panel or at the entry point of the pipe in the building. A gas-filled surge arrester with 230 V nominal voltage is switched to ground from each wire that is to be protected.

---

### Figure

Figure: STLSX2, STLSX4

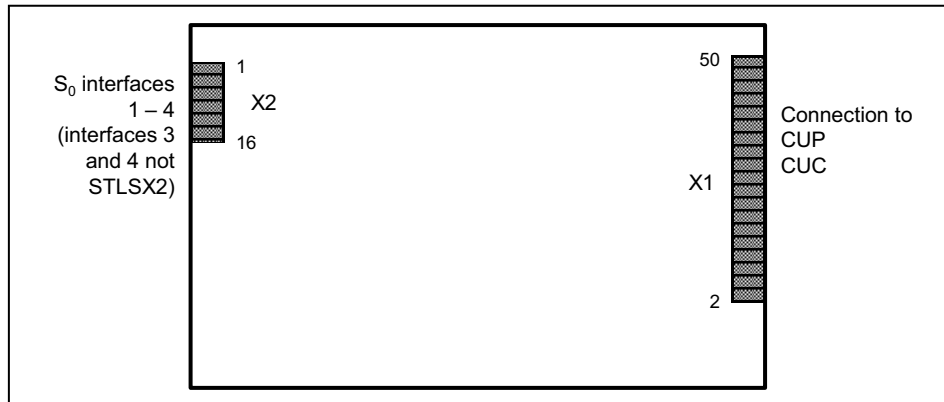
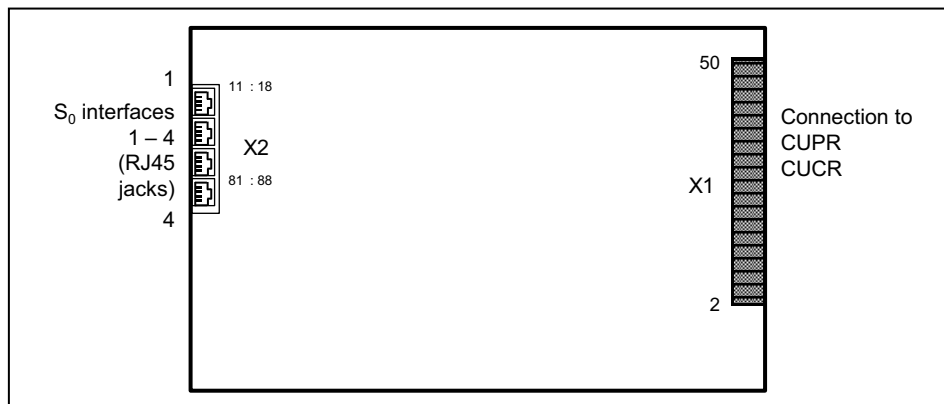


Figure: STLSX4R



### Pin Assignments

**Table:** STLSX2, STLSX4 – Pin Assignments

<b>X2</b>			
<b>Pin</b>	<b>S<sub>0</sub> ports 1 – 2</b>	<b>Pin</b>	<b>S<sub>0</sub> ports 3 – 4 (not STLSX2)</b>
1	S <sub>0</sub> -1 Transmit +	9	S <sub>0</sub> -3 Transmit +
2	S <sub>0</sub> -1 Receive +	10	S <sub>0</sub> -3 Receive +
3	S <sub>0</sub> -1 Receive –	11	S <sub>0</sub> -3 Receive –
4	S <sub>0</sub> -1 Transmit –	12	S <sub>0</sub> -3 Transmit –
5	S <sub>0</sub> -2 Transmit +	13	S <sub>0</sub> -4 Transmit +
6	S <sub>0</sub> -2 Receive +	14	S <sub>0</sub> -4 Receive +
7	S <sub>0</sub> -2 Receive –	15	S <sub>0</sub> -4 Receive –
8	S <sub>0</sub> -2 Transmit –	16	S <sub>0</sub> -4 Transmit –

**Table:** STLSX4R – Pin Assignments

<b>RJ45 jack</b>	<b>Pin</b>	<b>S<sub>0</sub> ports 1 – 4</b>
1	13	S <sub>0</sub> -1 Transmit +
	14	S <sub>0</sub> -1 Receive +
	15	S <sub>0</sub> -1 Receive –
	16	S <sub>0</sub> -1 Transmit –
2	13	S <sub>0</sub> -2 Transmit +
	14	S <sub>0</sub> -2 Receive +
	15	S <sub>0</sub> -2 Receive –
	16	S <sub>0</sub> -2 Transmit –
3	13	S <sub>0</sub> -3 Transmit +
	14	S <sub>0</sub> -3 Receive +
	15	S <sub>0</sub> -3 Receive –
	16	S <sub>0</sub> -3 Transmit –
4	13	S <sub>0</sub> -4 Transmit +
	14	S <sub>0</sub> -4 Receive +
	15	S <sub>0</sub> -4 Receive –
	16	S <sub>0</sub> -4 Transmit –

The RJ45 jacks each have four wires.

### 3.2.34 STMD3

The STMD3 board (Subscriber Trunk Module Digital  $S_0$ ) provides 8  $S_0$  interfaces which can be used for the ISDN trunk connection, tie-traffic (networking) or ISDN station connections (ISDN phones, Fax Group 4, etc.).

#### Board Variants and their Use

Board	Part Number	Used in		Maximum number
		Communication system	Country	
STMD3	S30810-Q2217-X10	OpenScape Business X8	ROW	8 (a maximum of 6 per system)

#### Usage Types

The setting of the usage type for each interface occurs via the WBM:

- ISDN trunk connection: point-to-point connection or point-to-multipoint connection
- ISDN station connection: internal  $S_0$  port

The connected ISDN phones cannot be adequately supplied with power. A local power supply (e.g., plug-in power supply) is required.

---

**NOTICE:** Fire hazard due to surge voltage

Only for the  $S_0$  station connection interfaces: In the case of line lengths exceeding 500 m and where the lines exit the building, the STMD3 board must be protected by external lightning protection.

Lightning protection of this kind is known as additional primary protection. The additional primary protection is guaranteed by installing ÜSAGs (surge arresters, gas filled) in the main distribution frame, the patch panel or at the entry point of the pipe in the building. A gas-filled surge arrester with 230 V nominal voltage is switched to ground from each wire that is to be protected.

---

#### Front Panel

To ensure sufficient shielding, the front panel of the board must be provided with a shielding panel.

**Figure:** STMD3 – LEDs on the Front Panel



### LEDs

The board features a front panel with two LEDs that indicate the operating states.

**Table:** STMD3 – LED Statuses and their Meanings

Red LED	Green LED	Meaning	Action
off	off	Board not receiving power or not plugged in correctly. Board is out of order.	Check plug contact on board.
on	off	Board is supplied with power. Board test in progress.	–
		Loadware loading failed. Board is faulty.	Replace board.
		Board was deactivated using Manager E.	Check whether the board was deactivated using Manager E. If not, the board is defective and must be replaced.
flashing	off	Loadware loading in progress.	–
off	on	Loadware loading completed successfully. Board is OK (idle state).	–
off	flashing	At least one channel is activated.	–

### Cable and Pin Assignments

There are several connection options for CO trunks, network trunks and ISDN phones:

- SIVAPAC connectors are available on the backplane for connecting the external main distribution frame MDFU-E or the external S<sub>0</sub> patch panel using CABLUs (prefabricated cabling units). See [Table: STMD3 – Cable and Pin Assignments \(SIVAPAC Connectors on the Backplane, MDFU-E, S<sub>0</sub> Patch Panel\)](#)
- Connector panels with CHAMP jacks for connecting the external main distribution frame MDFU-E or external S<sub>0</sub> patch panels using CABLUs. The

## Boards

### Description of the Boards

connector panels are clipped onto the SIVAPAC connectors on the backplane. See [Table: STMD3 – Cable and Pin Assignments \(Connector Panel with CHAMP Jack, MDFU-E, S<sub>0</sub> Patch Panel\)](#)

- Connector panels with 8 RJ45 jacks for connecting CO trunks, network trunks and ISDN phones directly. The connector panels are clipped onto the SIVAPAC connectors on the backplane. See [Table: STMD3 – Pin Assignments \(Connector Panel with 8 RJ45 Jacks\)](#)

**Table:** STMD3 – Cable and Pin Assignments (SIVAPAC Connectors on the Backplane, MDFU-E, S<sub>0</sub> Patch Panel)

STMD3 S <sub>0</sub> interface		Backplane SIVAPAC connector	Connection cable (CABLU)				MDFU-E	S <sub>0</sub> patch panel RJ45 jack			
No.	Signal	Pin	Color Group	Pair	A-wire	B-wire	Splitting strip	No.	Pin STN	Pin CO	
1	1Ea	1	1	1	white/blue		1a	1	3	4	
	1Eb	23				blue/white	1b		6	5	
	1Sa	3		2	white/orange		2a		4	3	
	1Sb	4				orange/white	2b		5	6	
2	2Ea	5		2	3	white/green		3a	2	3	4
	2Eb	6					green/white	3b		6	5
	2Sa	7			4	white/brown		4a		4	3
	2Sb	8					brown/white	4b		5	6
3	3Ea	9	2		5	white/gray		5a	3	3	4
	3Eb	10					gray/white	5b		6	5
	3Sa	11			6	red/blue		6a		4	3
	3Sb	12					blue/red	6b		5	6
4	4Ea	13		2	7	red/orange		7a	4	3	4
	4Eb	14					orange/red	7b		6	5
	4Sa	15			8	red/green		8a		4	3
	4Sb	16					green/red	8b		5	6
5	5Ea	17	2		9	red/brown		9a	5	3	4
	5Eb	18					brown/red	9b		6	5
	5Sa	19			10	red/gray		10a		4	3
	5Sb	20					gray/red	10b		5	6

STMD3 S <sub>0</sub> interface		Backplane SIVAPAC connector	Connection cable (CABLU)				MDFU-E	S <sub>0</sub> patch panel RJ45 jack			
No.	Signal	Pin	Color Group	Pair	A-wire	B-wire	Splitting strip	No.	Pin STN	Pin CO	
6	6Ea	24	3	11	black/blue		11a	6	3	4	
	6Eb	25				blue/black	11b		6	5	
	6Sa	26		12	black/orange		12a		4	3	
	6Sb	27				orange/black	12b		5	6	
7	7Ea	29		3	13	black/green		13a	7	3	4
	7Eb	30					green/black	13b		6	5
	7Sa	31			14	black/brown		14a		4	3
	7Sb	32					brown/black	14b		5	6
8	8Ea	34	4		15	black/gray		15a	8	3	4
	8Eb	35					gray/black	15b		6	5
	8Sa	37			16	yellow/blue		16a		4	3
	8Sb	38					blue/yellow	16b		5	6

## Boards

### Description of the Boards

**Table:** STMD3 – Cable and Pin Assignments (Connector Panel with CHAMP Jack, MDFU-E, S<sub>0</sub> Patch Panel)

STMD3 S <sub>0</sub> interface		Backplane CHAMP jack	Connection cable (CABLU)				MDFU-E	S <sub>0</sub> patch panel RJ45 jack			
No.	Signal	Pin	Color Group	Pair	A-wire	B-wire	Splitting strip	No.	Pin STN	Pin CO	
1	1Ea	1	1	1	white/blue		1a	1	3	4	
	1Eb	26				blue/white	1b		6	5	
	1Sa	2		2	white/orange		2a		4	3	
	1Sb	27				orange/white	2b		5	6	
2	2Ea	3		2	3	white/green		3a	2	3	4
	2Eb	28					green/white	3b		6	5
	2Sa	4			4	white/brown		4a		4	3
	2Sb	29					brown/white	4b		5	6
3	3Ea	5	2		5	white/gray		5a	3	3	4
	3Eb	30					gray/white	5b		6	5
	3Sa	6			6	red/blue		6a		4	3
	3Sb	31					blue/red	6b		5	6
4	4Ea	7		2	7	red/orange		7a	4	3	4
	4Eb	32					orange/red	7b		6	5
	4Sa	8			8	red/green		8a		4	3
	4Sb	33					green/red	8b		5	6
5	5Ea	9	2		9	red/brown		9a	5	3	4
	5Eb	34					brown/red	9b		6	5
	5Sa	10			10	red/gray		10a		4	3
	5Sb	35					gray/red	10b		5	6



STMD3 S <sub>0</sub> interface		Backplane CHAMP jack	Connection cable (CABLU)				MDFU-E	S <sub>0</sub> patch panel RJ45 jack			
No.	Signal	Pin	Color Group	Pair	A-wire	B-wire	Splitting strip	No.	Pin STN	Pin CO	
6	6Ea	11	3	11	black/blue		11a	6	3	4	
	6Eb	36				blue/black	11b		6	5	
	6Sa	12		12	black/orange		12a		4	3	
	6Sb	37				orange/black	12b		5	6	
7	7Ea	13		3	13	black/green		13a	7	3	4
	7Eb	38					green/black	13b		6	5
	7Sa	14			14	black/brown		14a		4	3
	7Sb	39					brown/black	14b		5	6
8	8Ea	15	4		15	black/gray		15a	8	3	4
	8Eb	40					gray/black	15b		6	5
	8Sa	16			16	yellow/blue		16a		4	3
	8Sb	41					blue/yellow	16b		5	6

**Table:** STMD3 – Pin Assignments (Connector Panel with 8 RJ45 Jacks)

STMD3 S <sub>0</sub> interface		Backplane RJ45 jack		
No.	Signal	No.	Pin Station connection	Pin Trunk connection/ Networking
1	1Ea	1	3	4
	1Eb		6	5
	1Sa		4	3
	1Sb		5	6
2	2Ea	2	3	4
	2Eb		6	5
	2Sa		4	3
	2Sb		5	6
3	3Ea	3	3	4
	3Eb		6	5
	3Sa		4	3
	3Sb		5	6
4	4Ea	4	3	4
	4Eb		6	5
	4Sa		4	3
	4Sb		5	6

## Boards

### Description of the Boards

STMD3 S <sub>0</sub> interface		Backplane RJ45 jack		
No.	Signal	No.	Pin Station connection	Pin Trunk connection/ Networking
5	5Ea	5	3	4
	5Eb		6	5
	5Sa		4	3
	5Sb		5	6
6	6Ea	6	3	4
	6Eb		6	5
	6Sa		4	3
	6Sb		5	6
7	7Ea	7	3	4
	7Eb		6	5
	7Sa		4	3
	7Sb		5	6
8	8Ea	8	3	4
	8Eb		6	5
	8Sa		4	3
	8Sb		5	6

### 3.2.35 STRB, STRBR

The STRB and STRBR options (optional control relay boards) provide four double-pin, switching relays (actuators) for special external connections (e.g., door openers) and four control inputs (sensors) for monitoring the status of connected equipment (e.g., motion detectors).

### Board Variants and their Use

Board	Part Number	Used in		Maximum number
		Communication system	Country	
STRB	S30817-Q932-A	OpenScape Business X3W OpenScape Business X5W	ROW	1
STRBR	S30817-H932-Z	OpenScape Business X3R OpenScape Business X5R	ROW	1

---

**NOTICE:** Fire hazard due to surge voltage

In the case of line lengths exceeding 500 m and where the lines exit the building, the STRB and STRBR boards must be protected by external lightning protection.

Lightning protection of this kind is known as additional primary protection. The additional primary protection is guaranteed by installing ÜSAGs (surge arresters, gas filled) in the main distribution frame, the patch panel or at the entry point of the pipe in the building. A gas-filled surge arrester with 230 V nominal voltage is switched to ground from each wire that is to be protected.

---

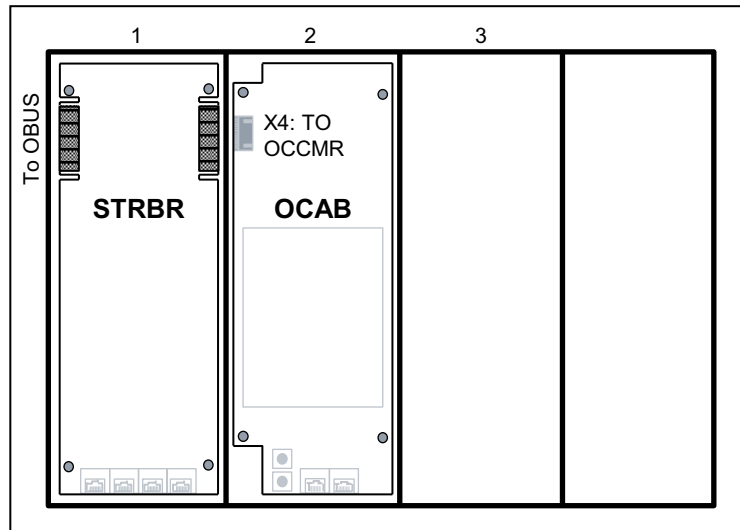
The board slot depends on the communication system:

- OpenScape Business X3R and X5R  
STRBR is mounted on the motherboard in option 1 of slot level 3 (X3R) or 5 (X5R) with the component side facing downwards. In addition, the STRBR must be secured to the metal panels of the OCCMR mainboard with the four supplied screws.  
The electrical connection to the OCCMR mainboard (OBUS plug contact) is established via the optional adapter cable OPALR (C39195-A7001-B142).

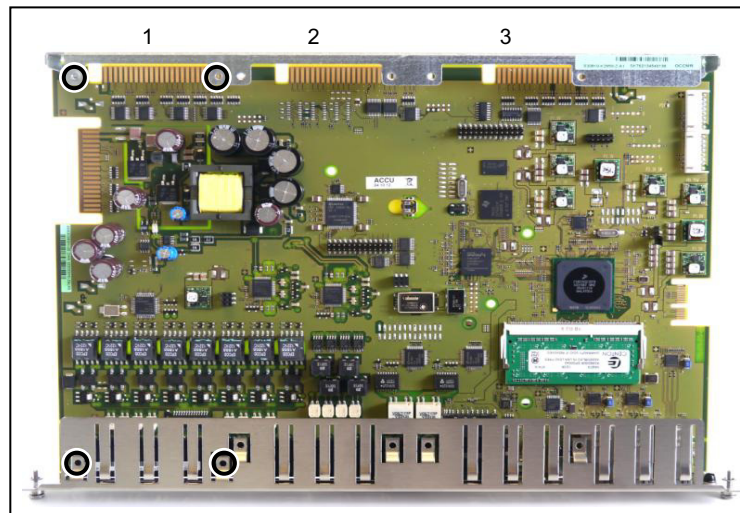
## Boards

### Description of the Boards

**Figure:** Option 1-3 on Slot Level 3/5 in OpenScape Business X3R/X5R

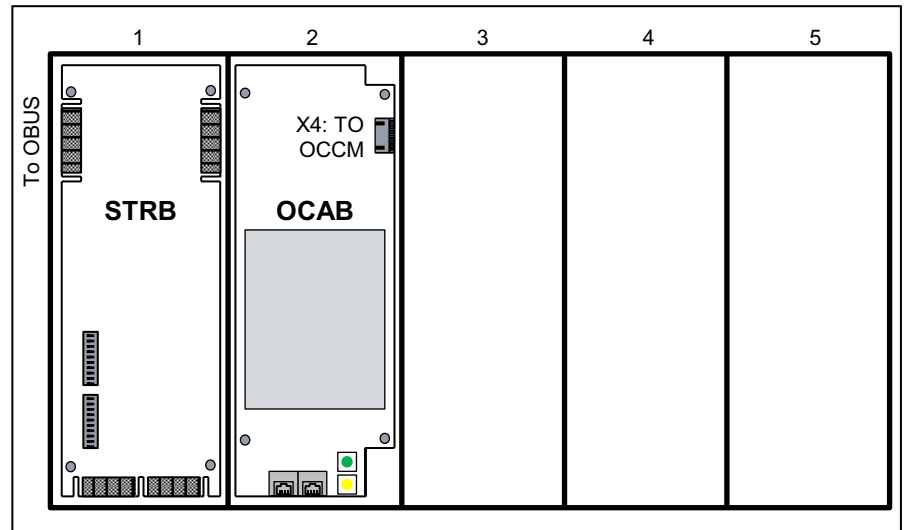


**Figure:** OCCMR - Position of Mounting Screws for STRBR



- OpenScape Business X3W and X5W  
STRB is inserted in option 1 of slot level 3 (X3W) or 6 (X5W) with the component side facing upwards.  
The electrical connection to the OCCM mainboard (OBUS plug contact) is established via the optional adapter cable OPAL (C39195-A7001-B130).

**Figure:** Option 1-5 on Slot Level 3/6 in OpenScape Business X3W/X5W



**Main Features**

The boards support

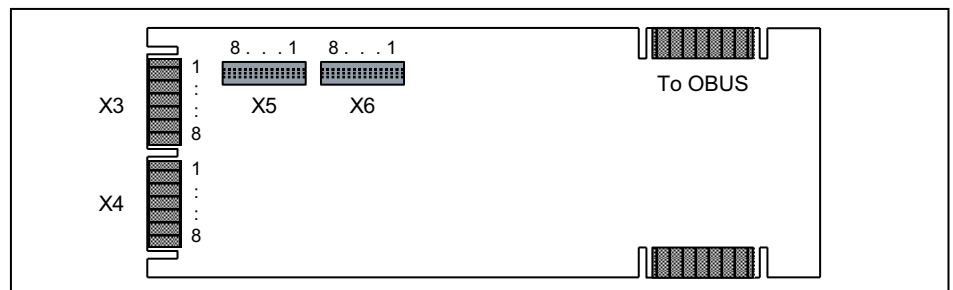
- four double-pin, double-throw relays for special connections such as door openers. The changeover contacts for all relays are floating.
- four control inputs in the form of optocouplers. These can be used to monitor the status of the connected equipment (e.g., for temperature control or motion detection). If a change of status in the connected equipment is detected, a preconfigured station number in the communication system can be dialed, for example.

An electrically isolated normally open (NO) contact is required for external activation of the optocouplers.

Example for STRB: Apply +12 V to the control input of optocoupler 1 via a normally open (NO) contact that is electrically isolated from the external equipment (+12 V at pin 8 of edge connector X4 (= OPTKP 1 = control input of optocoupler 1)).

**Figure**

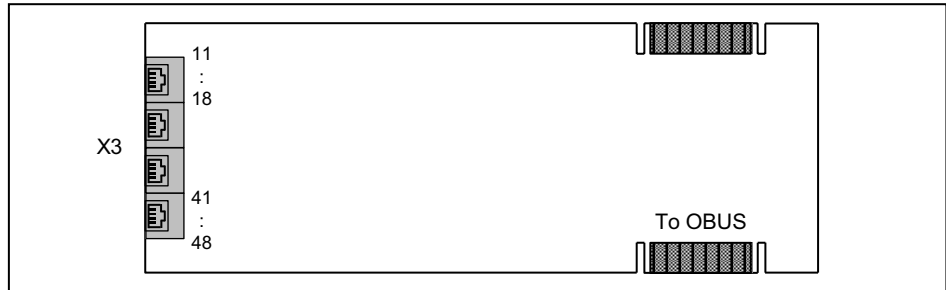
**Figure:** STRB



**Boards**

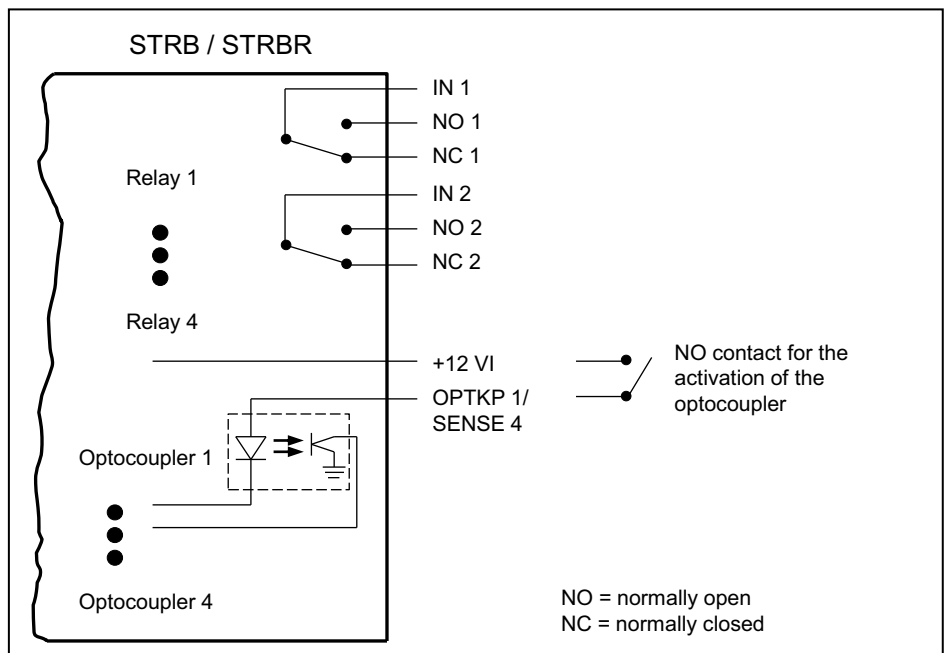
Description of the Boards

**Figure: STRBR**



**Block Diagram**

**Figure: STRB, STRBR – Block Diagram**



### Pin Assignments

**Table:** STRB – Pin Assignments of Edge Connectors and Connectors

Pin		Signal	Description
X3	1	K 4.21	Switching relay K4 IN 2
	2	K 4.22	Switching relay K4 Normally open contact (NOC) 2
	3	K 4.23	Switching relay K4 Normally closed contact (NCC) 2
	4	K 3.21	Switching relay K3 IN 2
	5	K 3.22	Switching relay K3 NOC 2
	6	K 3.23	Switching relay K3 NCC 2
	7	K 2.21	Switching relay K2 IN 2
	8	K 2.22	Switching relay K2 NOC 2
X4	1	K 2.23	Switching relay K2 NCC 2
	2	K 1.21	Switching relay K1 IN 2
	3	K 1.22	Switching relay K1 NOC 2
	4	K 1.23	Switching relay K1 NCC 2
	5	+12 VI	+12-V control voltage, optocoupler
	6	OPTKP 2	Control input optocoupler 2
	7	+12 VI	+12-V control voltage, optocoupler
	8	OPTKP 1	Control input optocoupler 1
X5	1	K 3.12	Switching relay K3 NOC 1
	2	K 3.13	Switching relay K3 NCC 1
	3	K 2.11	Switching relay K2 IN 1
	4	K 2.12	Switching relay K2 NOC 1
	5	K 2.13	Switching relay K2 NCC 1
	6	K 1.11	Switching relay K1 IN 1
	7	K 1.12	Switching relay K1 NOC 1
	8	K 1.13	Switching relay K1 NCC 1
X6	1	OPTKP 3	Control input optocoupler 3
	2	+12 VI	+12-V control voltage, optocoupler
	3	OPTKP 4	Control input optocoupler 4
	4	+12 VI	+12-V control voltage, optocoupler
	5	K 4.11	Switching relay K4 IN 1
	6	K 4.12	Switching relay K4 NOC 1
	7	K 4.13	Switching relay K4 NCC 1
	8	K 3.11	Switching relay K3 IN 1

## Boards

### Description of the Boards

**Table:** STRBR – Pin Assignments of the RJ45 Jack

Pin	Signal	Description
11	ACT4-2M	Switching relay K203 IN 2
12	ACT4-2B	Switching relay K203 NOC 2
13	ACT4-2A	Switching relay K203 NCC 2
14	ACT4-1M	Switching relay K203 IN 1
15	ACT4-1B	Switching relay K203 NOC 1
16	ACT4-1A	Switching relay K203 NCC 1
17	+12 VI	+12-V control voltage, optocoupler 4
18	SENSE 4	Control input optocoupler 4
21	ACT3-2M	Switching relay K202 IN 2
22	ACT3-2B	Switching relay K202 NOC 2
23	ACT3-2A	Switching relay K202 NCC 2
24	ACT3-1M	Switching relay K202 IN 1
25	ACT3-1B	Switching relay K202 NOC 1
26	ACT3-1A	Switching relay K202 NCC 1
27	+12 VI	+12-V control voltage, optocoupler 3
28	SENSE 3	Control input optocoupler 3
31	ACT2-2M	Switching relay K201 IN 2
32	ACT2-2B	Switching relay K201 NOC 2
33	ACT2-2A	Switching relay K201 NCC 2
34	ACT2-1M	Switching relay K201 IN 1
35	ACT2-1B	Switching relay K201 NOC 1
36	ACT2-1A	Switching relay K201 NCC 1
37	+12 VI	+12-V control voltage, optocoupler 2
38	SENSE 2	Control input optocoupler 2
41	ACT1-2M	Switching relay K200 IN 2
42	ACT1-2B	Switching relay K200 NOC 2
43	ACT1-2A	Switching relay K200 NCC 2
44	ACT1-1M	Switching relay K200 IN 1
45	ACT1-1B	Switching relay K200 NOC 1
46	ACT1-1A	Switching relay K200 NCC 1
47	+12 VI	+12-V control voltage, optocoupler 1
48	SENSE 1	Control input optocoupler 1



### 3.2.36 For Selected Countries Only: TCAS-2, TCASR-2

The TCASR and TCAS-2 boards (Trunk Line Channel Associated Signaling, rack) provide two CAS (Channel Associated Signaling) interfaces for the country-specific trunk connection with the CAS protocol.

#### Board Variants and their Use

Board	Part Number	Used in		Maximum number
		Communication system	Country	
TCAS-2	S30810-Q2945-X	OpenScape Business X3W OpenScape Business X5W	For selected countries only	1
TCASR-2	S30810-K2945-X	OpenScape Business X3R OpenScape Business X5R	For selected countries only	1

The TCASR and TCAS-2 boards may only be used in slots 7 and 9.

Each of the boards features two CAS interfaces, which together support up to 60 B channels. Since OpenScape Business X3W/X5W and OpenScape Business X3R/X5R each support a maximum of 30 B channels, a total of up to 30 B channels can be used per board.

---

**INFO:** For OpenScape Business X3W, CUX3W must be used as backplane.

For OpenScape Business X3R, CUX3R must be used as backplane.

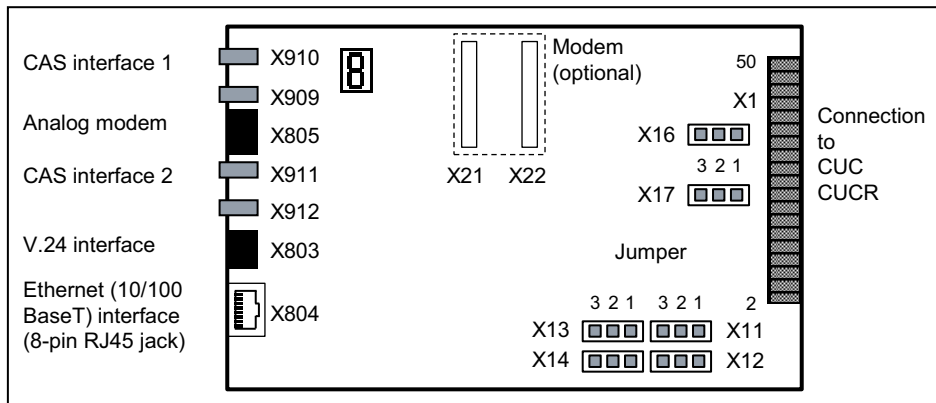
---

**Figure**

**Figure:** TCAS-2, TCASR-2



**Figure:** TCAS-2, TCASR-2 - Connectors and Jumpers



**Settings**

There board includes different jumpers that can be set as follows.

**Table:** TCAS-2, TCASR-2 – Jumper X11, X12, X14 for setting the V.24 baud rate

Jumper	V.24 baud rate (kbit/s)					
	9.6 (Default setting)	19.2	38,4	57,6	115.2	9.6
X11	Open	Open	Closed	Open	Closed	All other jumper settings
X12	Open	Open	Open	Closed	Closed	
X13	Open	Closed	Closed	Closed	Closed	

**Table:** TCAS-2, TCASR-2 - Jumpers X13, X16, X17

Jumper	Function	Setting	
		Pins 1–2 closed	Pins 2–3 closed
X13	Deletes the flash memory	Flash memory is cleared (all sectors apart from U-Boot (Universal Boot Loader) firmware).	Flash memory is not cleared (default).
X16	Resetting the card	Reset performed.	Reset not performed (default setting).
X17	Hardware watchdog	Watchdog is active (default setting).	Watchdog not active.

### Connectors

**Table:** TCAS-2, TCASR-2 - Connections

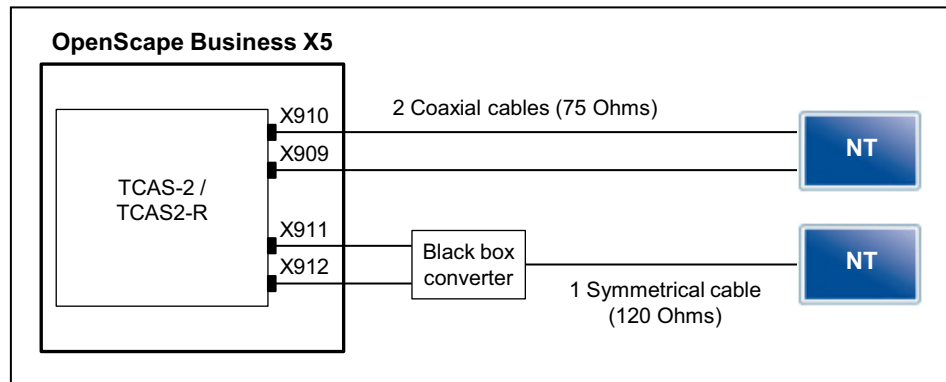
Connection		Type
X803	9-pin MINI DIN jack	V.24 interface
X804	8-pin RJ45 jack	Ethernet (10/100BaseT) interface  Two LEDs show the current interface status: <ul style="list-style-type: none"> <li>• Yellow LED = transmitting data</li> <li>• Green LED = receiving data</li> </ul>
X805	8-pin RJ45 jack	Analog modem (optional)

Connection		Type
X909	MINI BNC jack, 75 ohms Transmit (TX)	CAS interface 1
X910	MINI BNC jack, 75 ohms Receive (RX)	
X911	MINI BNC jack, 75 ohms Receive (RX)	CAS interface 2
X912	MINI BNC jack, 75 ohms Transmit (TX)	

Direct connection to the MINI BNC connectors on the boards is only possible for coaxial trunks (75 ohms). An external black box converter (75/120 ohms) must be used for symmetrical trunks (120 ohms).

**CAS cable**

**Figure:** TCAS-2, TCASR-2 - Ways to connect to the network terminator NT



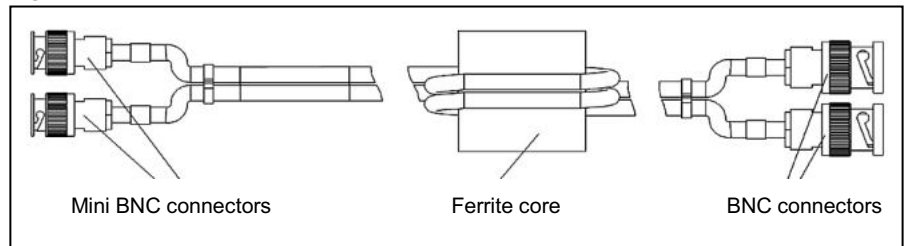
The following cable types can be used to connect to the network terminator NT:

- Coaxial line (75 ohms)  
For direct connection to the CAS interfaces (MINI-BNC connectors)  
To ensure sufficient electromagnetic shielding according to EN 55022, the cable shield of the two coaxial cables of each CAS interface must be conductively connected to the metal housing of the communication system. See [How to Connect the Cable Shield of the Coaxial Cables \(CAS Cables\) to the Housing of the OpenScope Business X5W Communication System](#)

**Table:** TCAS-2, TCASR-2 - Pin Assignments of CAS Cable C39195-A7700-B13

Function	MINI BNC connector	BNC connector	Trunk
A-wire, transmit	Conductor	Conductor	2
B-wire, transmit	Shield	Shield	
A-wire, receive	Conductor	Conductor	1
B-wire, receive	Shield	Shield	

**Figure:** TCAS-2, TCASR-2 - CAS cable C39195-A7700-B13



- symmetrical line (120 ohms)  
The connection to the CAS interfaces (MINI-BNC connectors) must be run through an external black box converter (75/120 ohms).  
To ensure adequate electromagnetic shielding according to EN 55022, the following must be performed for each CAS interface: The cable shield of the two coaxial cables that lead to the black box converter must be conductively connected to the metal housing of the communication system. See [How to Connect the Cable Shield of the Coaxial Cables \(CAS Cables\) to the Housing of the OpenScape Business X5W Communication System](#)

**Figure:** TCAS-2, TCASR-2 - Black Box converter (75/120 ohms)



### Seven-segment display

The software status of the boards can be determined on the basis of the seven-segment display.

After the power supply is turned on, a distinction can be made between the following start-up phases:

- Startup of the U-Boot (Universal Boot Loader) firmware

**Boards**

Description of the Boards

**Table:** TCAS-2, TCASR-2 - Statuses of the U-Boot (Universal Boot Loader) Firmware

Display	Meaning
H	Initializing hardware Downloading DSP (Digital Signal Processor) firmware Downloading FPGA (Field Programmable Gate Array) firmware
F	Accessing flash EPROM (Save and Delete)
b	Activating built-in self test BIST (BIST1 or BIST2)
A	Administration (Service PC connected)
C	Copying software (from SDRAM to FEPRM)
I	Downloading image file (Linux and CAS application)
L	Initializing the Linux operating system
E	Error
8	Resetting the card
.	The U-Boot firmware (Universal Boot Loader) is operational (decimal point flashing).

- Startup the Linux operating system

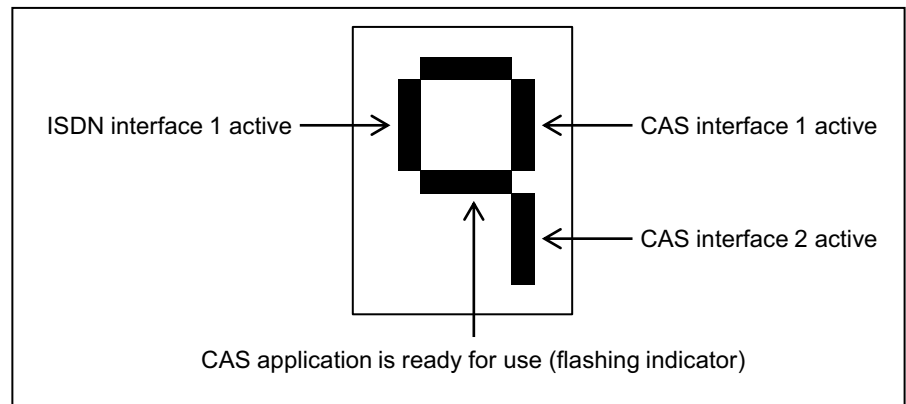
**Table:** TCAS-2, TCASR-2 - Statuses of the Linux operating system

Display	Meaning
	Linux kernel boot
	User space boot
.	Check and mount flash
2.	Error found, mounted file system rebuild, reboot
3.	Mounting flash file system

Display	Meaning
4.	Error mounting flash (flashing display)
5.	Configuring network interface
7.	Loading real-time kernel modules
9.	Loading board-specific modules
.	Core files available

- Startup of the CAS application software

**Figure:** TCAS-2, TCASR-2 - Statuses of the interfaces and the CAS application



### Administration of the CAS Protocol Converter

The administration of the CAS protocol converter on the TCAS-2 and TCASR-2 boards occurs via a separate tool, the CAS Manager. The CAS Manager software is stored on a CD supplied with the card. For information on how to install the software, refer to the ReadMe file.

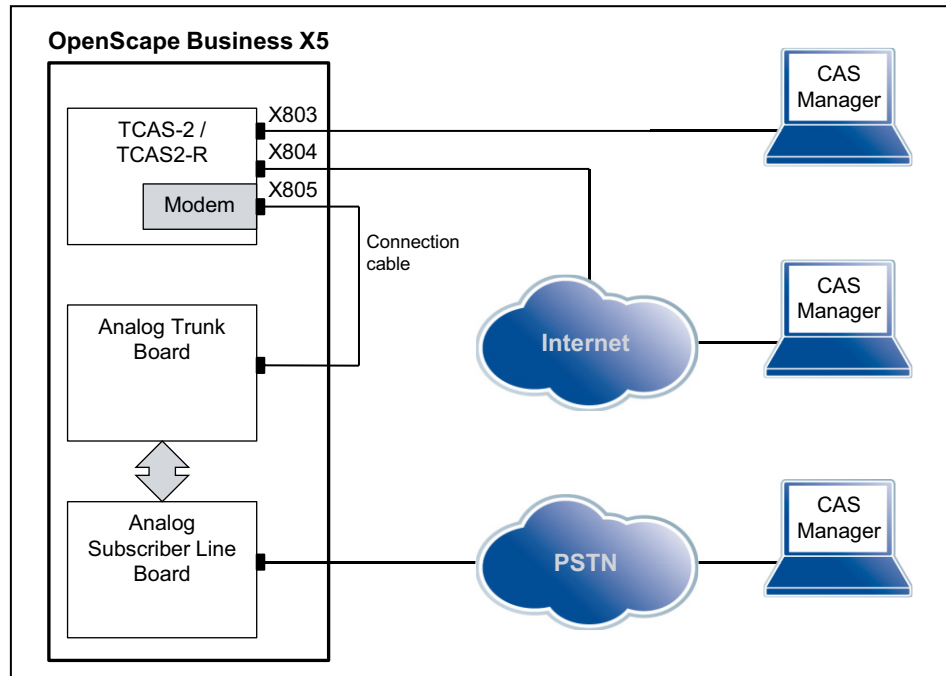
The boards can be accessed by the following methods (see [Figure: TCAS-2, TCASR-2 - Ways to Access the Boards](#)):

- V.24 interface = X803 (9-pin MINI DIN jack)
- Ethernet (10/100BaseT) interface = X804 (8-pin RJ45 jack)
- Analog modem

The analog modem is an optional submodule for the TCAS-2 and TCASR-2 cards, which is plugged into the X21 and X22 ports.

In this case, you will need to establish a connection from the analog modem (X805 (8-pin RJ45 jack)) to a free port on an analog subscriber line module. Remote access to the boards occurs via an analog trunk board.

**Figure:** TCAS-2, TCASR-2 - Ways to Access the Boards



### 3.2.36.1 How to Connect the Cable Shield of the Coaxial Cables (CAS Cables) to the Housing of the OpenScape Business X5W Communication System

To ensure adequate electromagnetic shielding according to EN 55022, the cable shield of the two coaxial cables must be conductively connected to the metal housing of the OpenScape Business X5W communication system.



#### **DANGER**

##### **Risk of electric shock through contact with live wires**

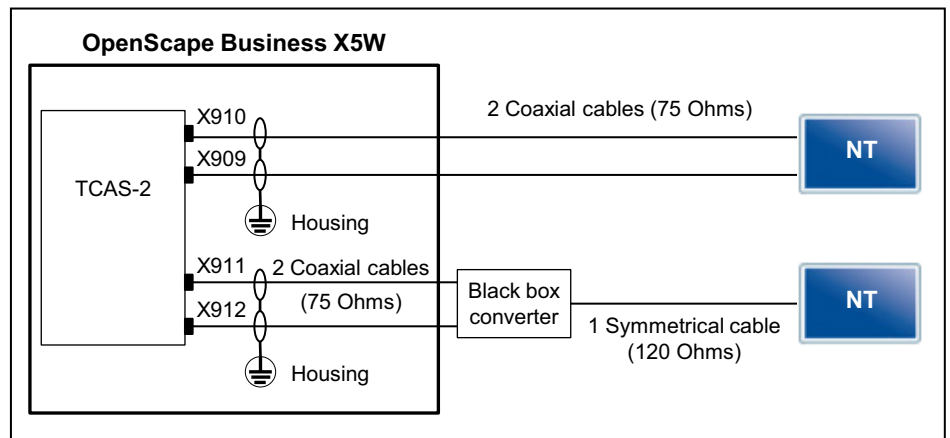
Disconnect all power supply circuits of the OpenScape Business X5W communication system before opening the housing:

- Disconnect the battery voltage, supply voltage and line voltage at any connected OpenScape Business Powerbox.
- Disconnect the line cords of any connected battery pack or any connected batteries.
- Disconnect the power plug of the communication system.

The cable shield of the two coaxial cables of each CAS interface must be conductively connected to the metal housing of the communication system (see figure below).



**Figure:** TCAS-2 – Connecting the Cable Shield to the Housing of the OpenScape Business X5W Communication System



**Step by Step**

- 1) Disconnect all power supply circuits of the OpenScape Business X5W communication system.
- 2) Make sure that the communication system is de-energized.
- 3) Loosen the two screwed plugs on the housing cover with a slotted screw driver. Hold the housing cover so that it does not fall.



- 4) Remove the housing cover.



---

**CAUTION**

**Cuts caused by sharp edges on the shielding plate**

Make sure that you only touch the outside of the housing cover. The shielding plate on the inside of the housing cover may have sharp edges which can cause cuts.

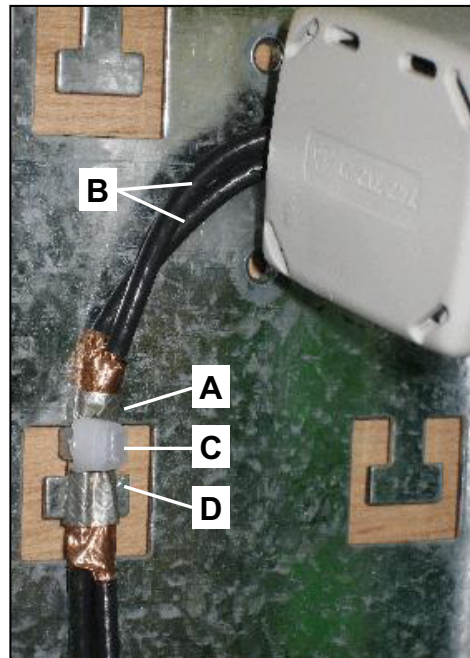
---



- 5) Strip the cable shield of the two coaxial cables of the first CAS interface over a length of about 3 cm. The exposed cable shield must be within range of a T tongue of the housing and as close to the TCAS-2 board connection as possible.
- 6) Connect the exposed cable shields of both coaxial cables by wrapping them with conductive adhesive tape (at least 1.5 times).
- 7) Use a cable tie [C] to attach the cable shield [A] (wrapped with the conductive tape) of the two coaxial cables [B] to one of the T tongues [D] of the housing

to ensure a permanent conductive connection between the cable shield and the housing.

When installing the two coaxial cables, ensure that the bending radius is not less than 45 degrees.



- 8) Repeat steps 5 through 7 for the two coaxial cables of the second CAS interface, if any.
- 9) Close the housing. To do this, put the housing cover on and secure it with the two screw caps. Make sure that you only touch the outside of the housing cover. The shielding plate on the inside of the housing cover may have sharp edges which can cause cuts.
- 10) Place the OpenScape Business X5W communication system back into operation.

### 3.2.37 ET-S

The ET-S adapter (entrance telephone) enables the connection of a to an entrance telephone/door opener.

The connection to the communication system is established via an a/b subscriber line interface.

**Board Variants and their Use**

Board	Part Number	Used in		Maximum number
		Communication system	Country	
ET-S	S30122-K7696-T313	OpenScape Business X3R OpenScape Business X3W OpenScape Business X5R OpenScape Business X5W OpenScape Business X8	ROW	4

---

**NOTICE:** The safety and installation instructions supplied with ET-S adapter must be observed!

---

**Pin Assignments**

**Table:** ET-S – Pin Assignments

Connection	a/b interfaces 1 – 4
a1 / b1	a/b subscriber line interfaces of the communication system
TO1 / TO2	Switching contact for door opener (normally open contact, max. 24 V / 2 A)
KL1 / KL2	Connection for floating doorbell button
a2 / b2	a/b interface for the entrance telephone
TS1 / TS2	Switching contact for entrance telephone amplifier
UB1 / UB2	Power supply ET-S adapter (7 - 19 VAC / 50 Hz or 10 - 24 VDC)

**3.2.38 TLANI2, TLANI4, TLANI4R**

The TLANI2, TLANI4 and TLANI4R boards provide two (TLANI2) and four a/b interfaces (TLANI4 and TLANI4R) for analog trunk connections (MSI: Ground Start or Loop Start).

The TLANI2, TLANI4 and TLANI4R boards are compatible successor modules for the following boards which cannot be used in the communication systems of the OpenScape Business communication platform for technical reasons:

- TLA2 (S30817-Q923-Bxxx)
- TLA4 (S30817-Q923-Axxx)
- TLA4R (S30817-K923-Zxxx)

- TMGL2 (S30810-Q2918-X100)
- TMGL4 (S30810-Q2918-X)
- TMGL4R (S30810-Q2918-Z)

**Board Variants and their Use**

Board	Part Number	Used in		Maximum number
		Communication system	Country	
TLANI2	S30810-Q2953-X100	OpenScape Business X3W	ROW	2
		OpenScape Business X5W		Is determined by the system-specific capacity limits.
TLANI2	S30810-Q2953-X182	OpenScape Business X3W	For Brazil only	2
		OpenScape Business X5W		Is determined by the system-specific capacity limits.
TLANI4	S30810-Q2953-X	OpenScape Business X3W	ROW	2
		OpenScape Business X5W		Is determined by the system-specific capacity limits.
TLANI4	S30810-Q2953-X82	OpenScape Business X3W	For Brazil only	2
		OpenScape Business X5W		Is determined by the system-specific capacity limits.
TLANI4R	S30810-K2953-X200	OpenScape Business X3R	ROW	2
		OpenScape Business X5R		Is determined by the system-specific capacity limits.
TLANI4R	S30810-K2953-X282	OpenScape Business X3R	For Brazil only	2
		OpenScape Business X5R		Is determined by the system-specific capacity limits.

---

**NOTICE:** Fire hazard due to surge voltage

In the case of line lengths exceeding 500 m and where the lines exit the building, the TLANI2, TLANI4 and TLAN4R boards must be protected by external lightning protection.

Lightning protection of this kind is known as additional primary protection. The additional primary protection is guaranteed by installing ÜSAGs (surge arresters, gas filled) in the main distribution frame, the patch panel or at the entry point of the pipe in the building. A gas-filled surge arrester with 230 V nominal voltage is switched to ground from each wire that is to be protected.

For U.S. and Canada only: The installation regulations require analog trunks to be connected using approved protectors as per UL 497A or CSA C22.2 No. 226.

---

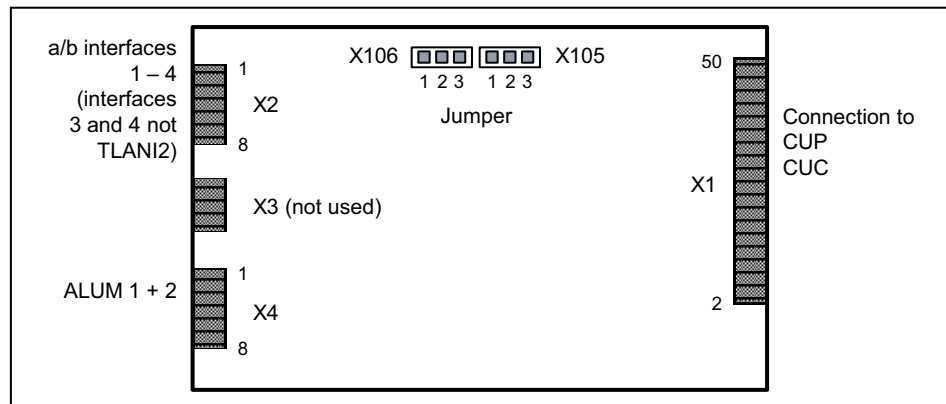
**Main Features**

The boards support

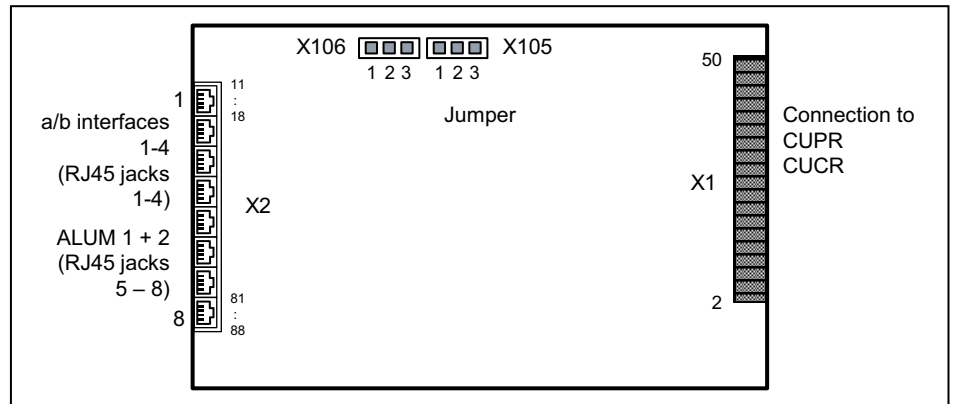
- calling name identification presentation (CLIP).
- call detail recording with 12 kHz and 16 kHz pulses. Call detail recording is selected automatically via the country setting of the communication system. The Brazilian board variants (TLANI2 S30810-Q2953-X182, TLANI4 S30810-Q2953-X82 and TLANI4R S30810-K2953-X282) do not support call detail recording with 12 kHz and 16 kHz pulses.
- "Silent Reversal", which is used in various countries to register the beginning and end of an outgoing call.
- two trunk failure transfer (ALUM) relays. In the event of a power failure or a fatal system error, up to two analog trunks can be directly connected to two analog telephones.

**Figure**

**Figure:** TLANI2, TLANI4



**Figure: TLANI4R**



### Settings

The boards include the jumpers X105 and X106 to set the procedure for the analog trunk connections.

- Loop start setting = pins 1–2 closed (default)
- Ground start setting = Pins 2 - 3 closed

### Pin Assignments

**Table: TLANI2, TLANI4 – Pin Assignments**

X2		X4		
Pin	a/b interfaces 1 – 4	Pin	ALUM 1 + 2	
1	a 1	1	b	ALUM 1: connection of subscriber line module
2	b 1	2	a	
3	a 2	3	b	ALUM 2: connection of subscriber line module
4	b 2	4	a	
5	a 3 (not TLANI2)	5	b	ALUM 1: connection of analog telephone
6	b 3 (not TLANI2)	6	a	
7	a 4 (not TLANI2)	7	b	ALUM 2: connecting of analog telephone
8	b 4 (not TLANI2)	8	a	

**Table: TLANI4R – Pin Assignments**

RJ45 jack	Pin	a/b interfaces 1 – 4 / ALUM 1 + 2
1	14	a 1
	15	b 1
2	24	a 2
	25	b 2

## Boards

### Description of the Boards

RJ45 jack	Pin	a/b interfaces 1 – 4 / ALUM 1 + 2	
3	34	a 3	
	35	b 3	
4	44	a 4	
	45	b 4	
5	54	b	ALUM 1: connection of subscriber line module
	55	a	
6	64	b	ALUM 2: connection of subscriber line module
	65	a	
7	74	b	ALUM 1: connection of analog telephone
	75	a	
8	84	b	ALUM 2: connecting of analog telephone
	85	a	
The RJ45 jacks each have two wires.			

### 3.2.39 TLANI8

The TLANI8 board provides eight a/b interfaces for analog trunk connections (MSI: Ground Start or Loop Start).

The TLANI8 board is the compatible successor module for the following board which cannot be used in OpenScape Business for technical reasons:

- TLA8 (S30817-Q926-Axxx)

#### Board Variants and their Use

Board	Part Number	Used in		Maximum number
		Communication system	Country	
TLANI8	S30810-Q2954-X100	OpenScape Business X3W	ROW	2
		OpenScape Business X5W		Is determined by the system-specific capacity limits.



Board	Part Number	Used in		Maximum number
		Communication system	Country	
TLANI8	S30810-Q2954-X101	OpenScape Business X3W	For international markets only	2
		OpenScape Business X5W		Is determined by the system-specific capacity limits.
TLANI8	S30810-Q2954-X182	OpenScape Business X3W	For Brazil only	2
		OpenScape Business X5W		Is determined by the system-specific capacity limits.

---

**NOTICE:** Fire hazard due to surge voltage

In the case of line lengths exceeding 500 m and where the lines exit the building, the TLANI8 board must be protected by external lightning protection.

Lightning protection of this kind is known as additional primary protection. The additional primary protection is guaranteed by installing ÜSAGs (surge arresters, gas filled) in the main distribution frame, the patch panel or at the entry point of the pipe in the building. A gas-filled surge arrester with 230 V nominal voltage is switched to ground from each wire that is to be protected.

For U.S. and Canada only: The installation regulations require analog trunks to be connected using approved protectors as per UL 497A or CSA C22.2 No. 226.

---

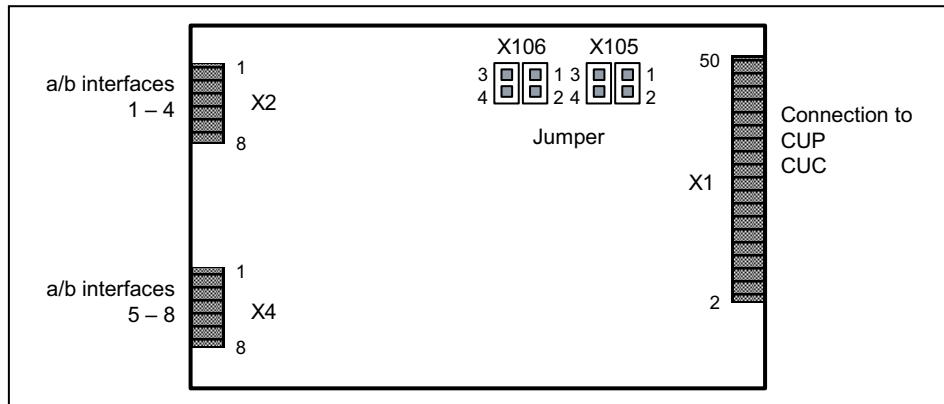
### Main Features

The board supports

- calling name identification presentation (CLIP).
- call detail recording with 12 kHz and 16 kHz pulses. Call detail recording is selected automatically via the country setting of the communication system. The board variants for international markets (S30810-Q2954-X101) and for Brazil (S30810-Q2954-X182) do not support call detail recording with 12 kHz and 16 kHz pulses.
- "Silent Reversal", which is used in various countries to register the beginning and end of an outgoing call.

**Figure**

**Figure:** TLANI8



**Settings**

The board includes the jumpers X105 and X106 to set the procedure for the analog trunk connections.

- Loop start setting = pins 3–4 closed (default)
- Ground start setting = pins 1–2 closed

**Pin Assignments**

**Table:** TLANI8 – Pin Assignments

X2		X4	
Pin	a/b interfaces 1 – 4	Pin	a/b interfaces 5 – 8
1	a 1	1	a 5
2	b 1	2	b 5
3	a 2	3	a 6
4	b 2	4	b 6
5	a 3	5	a 7
6	b 3	6	b 7
7	a 4	7	a 8
8	b 4	8	b 8

**3.2.40 TMANI**

The TMANI board provides eight a/b interfaces for analog trunk connections (MSI: Ground Start or Loop Start).

The TMANI board is a compatible successor to the following boards, which will be discontinued:

- TM2LP (S30810-Q2159-Xxxx)

- TMC16 (S30810-Q2485-X)

### Board Variants and their Use

Board	Part Number	Used in		Maximum number
		Communication system	Country	
TMANI	S30810-Q2327-X	OpenScape Business X8	ROW	Is determined by the system-specific capacity limits.
TMANI	S30810-Q2327-X1	OpenScape Business X8	For international markets only	Is determined by the system-specific capacity limits.
TMANI	S30810-Q2327-X82	OpenScape Business X8	For Brazil only	Is determined by the system-specific capacity limits.

---

**NOTICE:** Fire hazard due to surge voltage

In the case of line lengths exceeding 500 m and where the lines exit the building, the TMANI board must be protected by external lightning protection.

Lightning protection of this kind is known as additional primary protection. The additional primary protection is guaranteed by installing ÜSAGs (surge arresters, gas filled) in the main distribution frame, the patch panel or at the entry point of the pipe in the building. A gas-filled surge arrester with 230 V nominal voltage is switched to ground from each wire that is to be protected.

For U.S. and Canada only: The installation regulations require analog trunks to be connected using approved protectors as per UL 497A or CSA C22.2 No. 226.

---

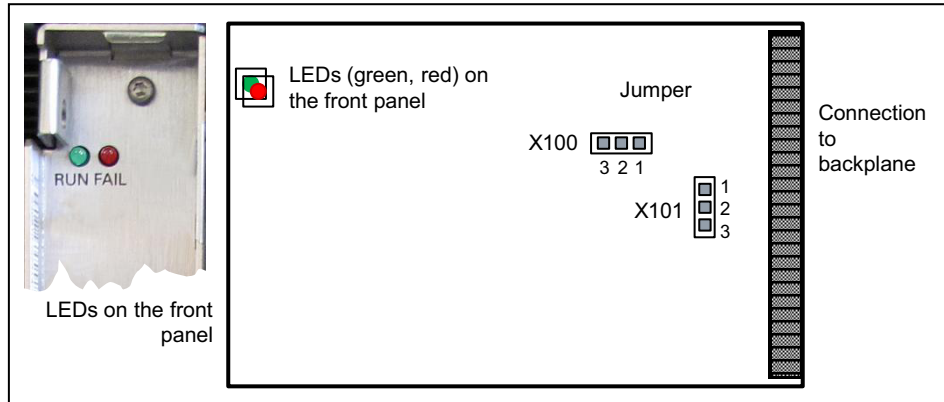
### Main Features

The board supports

- calling name identification presentation (CLIP).
- call detail recording with 12 kHz and 16 kHz pulses. Call detail recording is selected automatically via the country setting of the communication system. The board variants for international markets (S30810-Q2327-X1) and for Brazil (S30810-Q2327-X82) do not support call detail recording with 12 kHz and 16 kHz pulses.
- "Silent Reversal", which is used in various countries to register the beginning and end of an outgoing call.

**Figure**

**Figure:** TMANI



**Settings**

The board includes the jumpers X100 and X101 to set the procedure for the analog trunk connections.

- Loop start setting = pins 1–2 closed (default)
- Ground start setting = Pins 2 - 3 closed

**LEDs**

The board features a front panel with two LEDs that indicate the operating states.

**Table:** TMANI – LED Statuses and their Meanings

Red LED	Green LED	Meaning	Action
off	off	Board not receiving power or not plugged in correctly. Board is out of order.	Check plug contact on board.
on	off	Board is supplied with power. Board test in progress.	–
		Loadware loading failed. Board is faulty.	Replace board.
		Board was deactivated using Manager E.	Check whether the board was deactivated using Manager E. If not, the board is defective and must be replaced.
flashing	off	Loadware loading in progress.	–
off	on	Loadware loading completed successfully. Board is OK (idle state).	–
off	flashing	At least one channel is activated.	–

### Cable and Pin Assignments

There are several connection options for analog CO trunks:

- SIVAPAC connectors are available on the backplane for connecting the external main distribution frame MDFU-E or the external patch panel using CABLUs (prefabricated cabling units). See [Table: TMANI – Cable and Pin Assignments \(SIVAPAC Connectors on the backplane, MDFU-E, Patch Panel\)](#)
- Connector panels with CHAMP jacks for connecting the external main distribution frame MDFU-E or external patch panels using CABLUs. The connector panels are clipped onto the SIVAPAC connectors on the backplane. See [Table: TMANI – Cable and Pin Assignments \(Connector Panel with CHAMP Jack, MDFU-E, Patch Panel\)](#)
- Connector panels with 24 RJ45 jacks for connecting analog trunks directly. The connector panels are clipped onto the SIVAPAC connectors on the backplane. See [Table: TMANI – Pin Assignments \(Connector Panel with 24 RJ45 Jacks\)](#)

**Table:** TMANI – Cable and Pin Assignments (SIVAPAC Connectors on the backplane, MDFU-E, Patch Panel)

TMANI a/b interface		Backplane SIVAPAC connector	Connection cable (CABLU)				MDFU-E	Patch Panel RJ45 jack	
No.	Signal	Pin	Color Group	Pair	A-wire	B-wire	Splitting strip	No.	Pin
1	1a	1	1	1	white/blue		1a	1	4
	1b	23				blue/white	1b		5
2	2a	3		2	white/orange		2a	2	4
	2b	4				orange/white	2b		5
3	3a	5		3	white/green		3a	3	4
	3b	6				green/white	3b		5
4	4a	7		4	white/brown		4a	4	4
	4b	8				brown/white	4b		5
5	5a	9		5	white/gray		5a	5	4
	5b	10				gray/white	5b		5

## Boards

### Description of the Boards

TMANI a/b interface		Backplane SIVAPAC connector	Connection cable (CABLU)				MDFU-E	Patch Panel RJ45 jack	
No.	Signal	Pin	Color Group	Pair	A-wire	B-wire	Splitting strip	No.	Pin
6	6a	11	2	6	red/blue		6a	6	4
	6b	12				blue/red	6b		5
7	7a	13		7	red/orange		7a	7	4
	7b	14				orange/red	7b		5
8	8a	15		8	red/green		8a	8	4
	8b	16				green/red	8b		5
-	-	17		9	red/brown		9a	9	4
	-	18				brown/red	9b		5
-	-	19		10	red/gray		10a	10	4
	-	20				gray/red	10b		5
-	-	24	3	11	black/blue		11a	11	4
	-	25				blue/black	11b		5
-	-	26		12	black/orange		12a	12	4
	-	27				orange/black	12b		5
-	-	29		13	black/green		13a	13	4
	-	30				green/black	13b		5
-	-	31		14	black/brown		14a	14	4
	-	32				brown/black	14b		5
-	-	34		15	black/gray		15a	15	4
	-	35				gray/black	15b		5
-	-	37	4	16	yellow/blue		16a	16	4
	-	38				blue/yellow	16b		5

**Table:** TMANI – Cable and Pin Assignments (Connector Panel with CHAMP Jack, MDFU-E, Patch Panel)

TMANI a/b interface		Backplane CHAMP jack	Connection cable (CABLU)				MDFU-E	Patch Panel RJ45 jack		
No.	Signal	Pin	Color Group	Pair	A-wire	B-wire	Splitting strip	No.	Pin	
1	1a	1	1	1	white/blue		1a	1	4	
	1b	26				blue/white	1b		5	
2	2a	2		2	2	white/orange		2a	2	4
	2b	27					orange/white	2b		5
3	3a	3		3	3	white/green		3a	3	4
	3b	28					green/white	3b		5
4	4a	4		4	4	white/brown		4a	4	4
	4b	29					brown/white	4b		5
5	5a	5		5	5	white/gray		5a	5	4
	5b	30					gray/white	5b		5
6	6a	6	2	6	red/blue		6a	6	4	
	6b	31				blue/red	6b		5	
7	7a	7		7	7	red/orange		7a	7	4
	7b	32					orange/red	7b		5
8	8a	8		8	8	red/green		8a	8	4
	8b	33					green/red	8b		5
–	–	9		9	9	red/brown		9a	9	4
	–	34					brown/red	9b		5
–	–	10		10	10	red/gray		10a	10	4
	–	35					gray/red	10b		5
–	–	11	3	11	black/blue		11a	11	4	
	–	36				blue/black	11b		5	
–	–	12		12	12	black/orange		12a	12	4
	–	37					orange/black	12b		5
–	–	13		13	13	black/green		13a	13	4
	–	38					green/black	13b		5
–	–	14		14	14	black/brown		14a	14	4
	–	39					brown/black	14b		5
–	–	15		15	15	black/gray		15a	15	4
	–	40					gray/black	15b		5
–	–	16	4	16	yellow/blue		16a	16	4	
	–	41				blue/yellow	16b		5	

## Boards

### Description of the Boards

**Table:** TMANI – Pin Assignments (Connector Panel with 24 RJ45 Jacks)

TMANI a/b interface		Backplane RJ45 jack	
No.	Signal	No.	Pin
1	1a	1	4
	1b		5
2	2a	2	4
	2b		5
3	3a	3	4
	3b		5
4	4a	4	4
	4b		5
5	5a	5	4
	5b		5
6	6a	6	4
	6b		5
7	7a	7	4
	7b		5
8	8a	8	4
	8b		5
–	–	9	4
	–		5
–	–	10	4
	–		5
–	–	11	4
	–		5
–	–	12	4
	–		5
–	–	13	4
	–		5
–	–	14	4
	–		5
–	–	15	4
	–		5
–	–	16	4
	–		5



TMANI a/b interface		Backplane RJ45 jack	
No.	Signal	No.	Pin
–	–	17	4
	–		5
–	–	18	4
	–		5
–	–	19	4
	–		5
–	–	20	4
	–		5
–	–	21	4
	–		5
–	–	22	4
	–		5
–	–	23	4
	–		5
–	–	24	4
	–		5

### 3.2.41 For Selected Countries Only: TMCAS2

The TMCAS2 board (Trunk Module Channel Associated Signaling, Rack) provides two CAS (Channel Associated Signaling) interfaces and thus up to 60 B channels for the country-specific trunk connection with the CAS protocol.

The TMCAS2 board is a compatible successor to the following board, which will be discontinued:

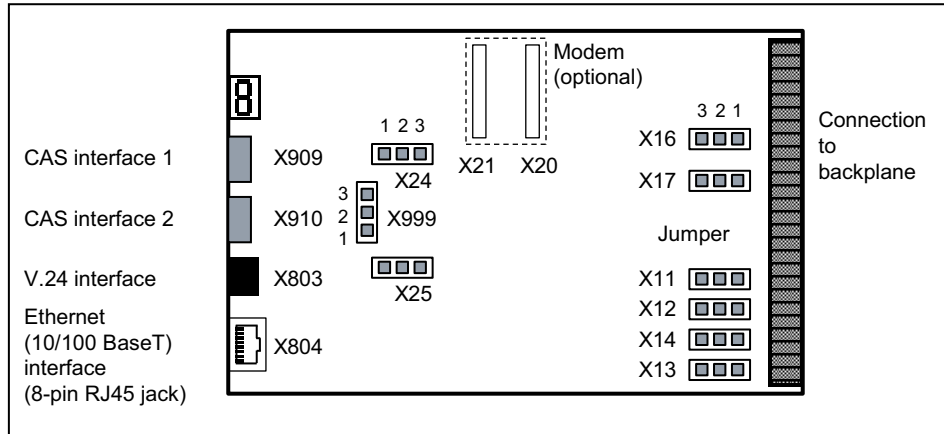
- TMCAS (S30810-Q2938-X)

#### Board Variants and their Use

Board	Part Number	Used in		Maximum number
		Communication system	Country	
TMCAS2	S30810-Q2946-X	OpenScape Business X8	For selected countries only	3

**Figure**

**Figure:** TMCAS2



**Settings**

There board includes different jumpers that can be set as follows.

**Table:** TMCAS2 – Jumper X11, X12, X14 for Setting the V.24 Baud Rate

Jumper	V.24 baud rate (kbit/s)					
	9.6 (Default setting)	19.2	38,4	57,6	115.2	9.6
X11	Open	Open	Closed	Open	Closed	All other jumper settings
X12	Open	Open	Open	Closed	Closed	
X13	Open	Closed	Closed	Closed	Closed	

**Table:** TMCAS2 - Jumpers X13, X16, X17, X24, X25, X999

Jumper	Function	Setting	
		Pins 1–2 closed	Pins 2–3 closed
X13	Deletes the flash memory	Flash memory is cleared (all sectors apart from U-Boot (Universal Boot Loader) firmware).	Flash memory is not cleared (default).
X16	Resetting the card	Reset performed.	Reset not performed (default setting).
X17	Hardware watchdog	Watchdog is active (default setting).	Watchdog not active.

Jumper	Function	Setting	
		Pins 1–2 closed	Pins 2–3 closed
X24	Sets trunk impedance for CAS interface 1	75 ohms (default setting)	120 ohms
X25	Sets trunk impedance for CAS interface 2	75 ohms (default setting)	120 ohms
X999	Grounding: board / CAS cable	Grounding for the card is connected to the grounding for the CAS cable.	Grounding for the board is not connected to the grounding for the CAS cable (default setting).

### Connectors

**Table:** TMCAS2 - Connections

Connection		Type
X803	9-pin MINI DIN jack	V.24 interface
X804	8-pin RJ45 jack	Ethernet (10/100BaseT) interface Two LEDs show the current interface status: <ul style="list-style-type: none"> <li>• Yellow LED = transmitting data</li> <li>• Green LED = receiving data</li> </ul>
X909	15-pin Sub-D jack	CAS interface 1
X910	15-pin Sub-D jack	CAS interface 2

### CAS cable

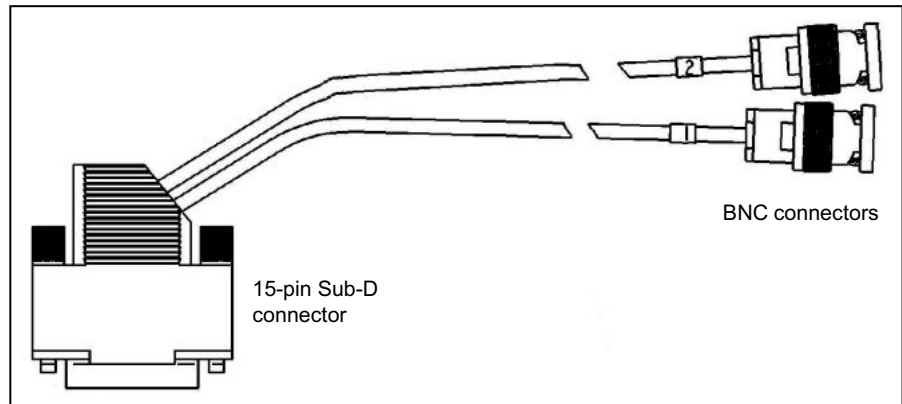
The following cable types can be used to connect to the network terminator NT:

- Coaxial line (75 ohms)

**Table:** TMCAS2 – Pin Assignments of the CAS Cable C39195-A7700-B14

15-pin Sub-D connector Pin	Function	BNC connector	Trunk
9	A-wire, transmit	Conductor	2
1	B-wire, transmit	Shield	
15	A-wire, receive	Conductor	1
8	B-wire, receive	Shield	

**Figure:** TMCAS2 - CAS cable C39195-A7700-B14



- symmetrical line (120 ohms)

**Table:** TMCAS2 – Pin Assignments of the CAS Cable S30267-Z167-Ax00

15-pin Sub-D connector Pin	Function	Color code
9	A-wire, transmit	wht/blu
1	B-wire, transmit	blu/wht
15	A-wire, receive	wht/ora
8	B-wire, receive	ora/wht

**Seven-segment display**

The card's software status can be ascertained on the basis of the seven-segment display.

After the power supply is turned on, a distinction can be made between the following start-up phases:

- Startup of the U-Boot (Universal Boot Loader) firmware

**Table:** TMCAS2 - Statuses of the U-Boot (Universal Boot Loader) Firmware

Display	Meaning
H	Initializing hardware Downloading DSP (Digital Signal Processor) firmware Downloading FPGA (Field Programmable Gate Array) firmware
F	Accessing flash EPROM (Save and Delete)
b	Activating built-in self test BIST (BIST1 or BIST2)
R	Administration (Service PC connected)

Display	Meaning
C	Copying software (from SDRAM to FEPRM)
I	Downloading image file (Linux and CAS application)
L	Initializing the Linux operating system
E	Error
8	Resetting the card
.	The U-Boot firmware (Universal Boot Loader) is operational (decimal point flashing).

- Startup the Linux operating system

**Table:** TMCAS2 – Linux Operating System States

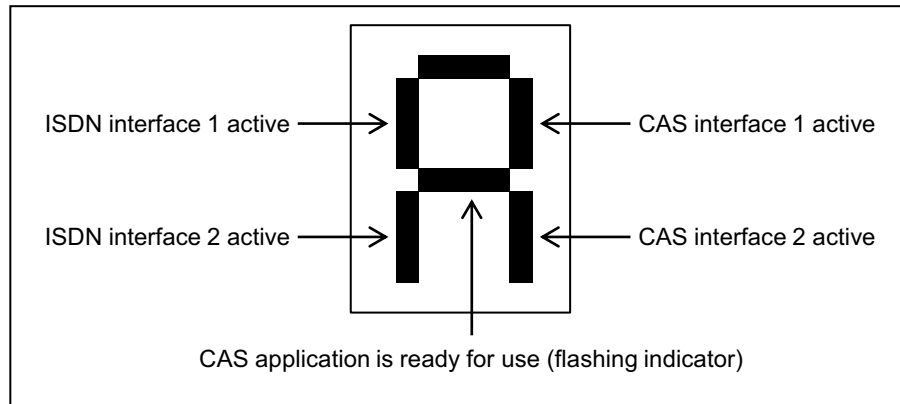
Display	Meaning
	Linux kernel boot
	User space boot
.	Check and mount flash
2.	Error found, mounted file system rebuild, reboot
3	Mounting flash file system
4.	Error mounting flash (flashing display)
5	Configuring network interface
7	Loading real-time kernel modules
9	Loading board-specific modules
.	Core files available

- Startup of the CAS application software

## Boards

### Description of the Boards

**Figure:** TMCAS2 - Statuses of the Interfaces and the CAS Application



### Administration of the CAS Protocol Converter

The administration of the CAS protocol converter on the TMCAS2 board occurs via a separate tool, the CAS Manager. The CAS Manager software is stored on a CD supplied with the card. For information on how to install the software, refer to the ReadMe file.

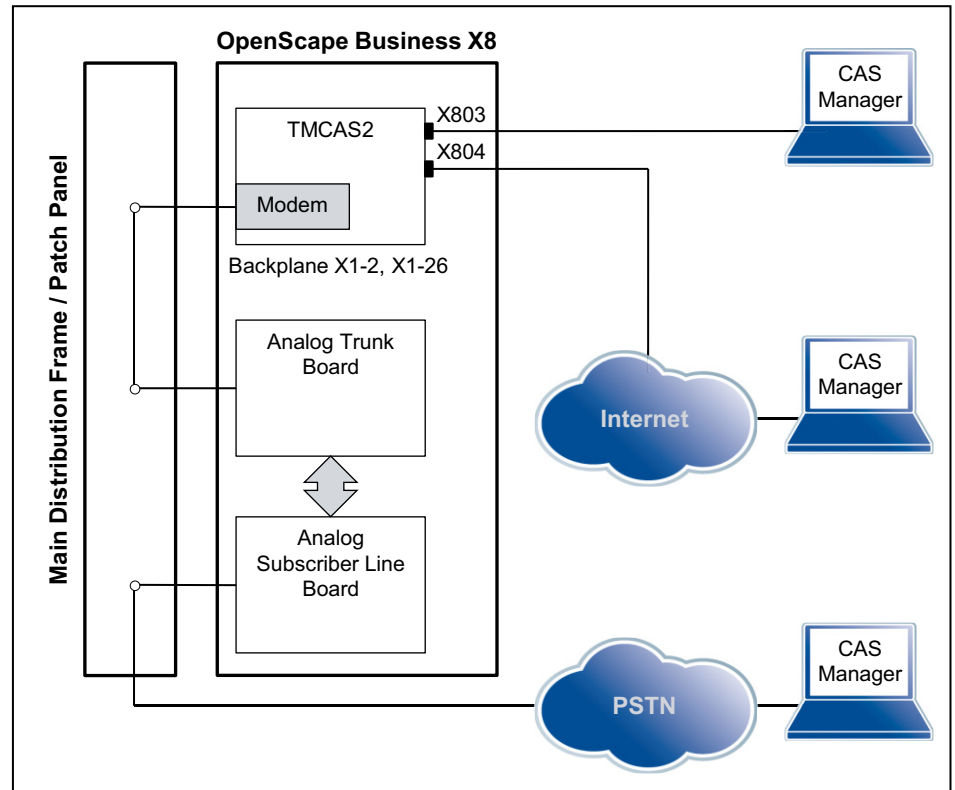
The board can be accessed by the following methods (see [Figure: TMCAS2 – Ways to Access the Board](#)):

- V.24 interface = X803 (9-pin MINI DIN jack)
- Ethernet (10/100BaseT) interface = X804 (8-pin RJ45 jack)
- Analog modem

The analog modem is an optional subboard for the TMCAS2 card, which is plugged into the X20 and X21 ports.

In this case, you will need to establish a connection from the analog modem to a free port on an analog subscriber line module. A connection cable (open-end cable (24 TW): S30267-Z196-A150 = 15 m in length, S30267-Z196 A250 = 25 m in length) is used to connect the TMCAS2 (backplane X1-2, X1-26) to the main distribution frame/patch panel. Insert the required jumpers in the main distribution frame or patch panel. Remote access to the TMCAS2 board occurs via an analog trunk board.

**Figure:** TMCAS2 – Ways to Access the Board



### 3.2.42 For Selected Countries Only: TMDID

The TMDID (Trunk Module Direct Inward Dialing) board provides eight a/b interfaces for direct inward dialing from the central office (CO) to the communication system. Only incoming connections are possible.

The following signaling protocols are supported: Wink Start, Delay Dial and Immediate Start.

The TMDID board is the compatible successor module for the following board which cannot be used in OpenScape Business for technical reasons:

- TMDID (S30810-Q2452-X)

#### Board Variants and their Use

Board	Part Number	Used in		Maximum number
		Communication system	Country	
TMDID	S30810-Q2197-T	OpenScape Business X8	For selected countries only	Is determined by the system-specific capacity limits.

## Boards

### Description of the Boards

---

**NOTICE:** Fire hazard due to surge voltage

In the case of line lengths exceeding 500 m and where the lines exit the building, the TMDID board must be protected by external lightning protection.

Lightning protection of this kind is known as additional primary protection. The additional primary protection is guaranteed by installing ÜSAGs (surge arresters, gas filled) in the main distribution frame, the patch panel or at the entry point of the pipe in the building. A gas-filled surge arrester with 230 V nominal voltage is switched to ground from each wire that is to be protected.

For U.S. and Canada only: The installation regulations require analog trunks to be connected using approved protectors as per UL 497A or CSA C22.2 No. 226.

---

### Front Panel

To ensure sufficient shielding, the board must be provided with a shielding panel.

**Figure:** TMDID – LEDs on the Front Panel



### LEDs

The board features a front panel with two LEDs that indicate the operating states.

**Table:** TMDID – LED Statuses and their Meanings

Red LED	Green LED	Meaning	Action
off	off	Board not receiving power or not plugged in correctly. Board is out of order.	Check plug contact on board.



Red LED	Green LED	Meaning	Action
on	off	Board is supplied with power. Board test in progress.	–
		Loadware loading failed. Board is faulty.	Replace board.
		Board was deactivated using Manager E.	Check whether the board was deactivated using Manager E. If not, the board is defective and must be replaced.
flashing	off	Loadware loading in progress.	–
off	on	Loadware loading completed successfully. Board is OK (idle state).	–
off	flashing	At least one channel is activated.	–

### Cable and Pin Assignments

There are several connection options for analog CO trunks:

- SIVAPAC connectors are available on the backplane for connecting the external main distribution frame MDFU-E or the external patch panel using CABLUs (prefabricated cabling units). See [Table: TMDID – Cable and Pin Assignments \(SIVAPAC connectors on the Backplane, MDFU-E, Patch Panel\)](#)
- Connector panels with CHAMP jacks for connecting the external main distribution frame MDFU-E or external patch panels using CABLUs. The connector panels are clipped onto the SIVAPAC connectors on the backplane. See [Table: TMDID – Cable and Pin Assignments \(Connector Panel with CHAMP Jack, MDFU-E, Patch Panel\)](#)
- Connector panels with 24 RJ45 jacks for connecting analog trunks directly. The connector panels are clipped onto the SIVAPAC connectors on the backplane. See [Table: TMDID – Pin Assignments \(Connector Panel with 24 RJ45 Jacks\)](#)

## Boards

### Description of the Boards

**Table:** TMDID – Cable and Pin Assignments (SIVAPAC connectors on the Backplane, MDFU-E, Patch Panel)

TMDID a/b interface		Backplane SIVAPAC connector	Connection cable (CABLU)				MDFU-E	Patch Panel RJ45 jack	
No.	Signal	Pin	Color Group	Pair	A-wire	B-wire	Splitting strip	No.	Pin
1	1a	1	1	1	white/blue		1a	1	4
	1b	23				blue/white	1b		5
2	2a	3		2	white/orange		2a	2	4
	2b	4				orange/white	2b		5
3	3a	5		3	white/green		3a	3	4
	3b	6				green/white	3b		5
4	4a	7		4	white/brown		4a	4	4
	4b	8				brown/white	4b		5
5	5a	9		5	white/gray		5a	5	4
	5b	10				gray/white	5b		5
6	6a	11	2	6	red/blue		6a	6	4
	6b	12				blue/red	6b		5
7	7a	13		7	red/orange		7a	7	4
	7b	14				orange/red	7b		5
8	8a	15		8	red/green		8a	8	4
	8b	16				green/red	8b		5
-	-	17		9	red/brown		9a	9	4
	-	18				brown/red	9b		5
-	-	19		10	red/gray		10a	10	4
	-	20				gray/red	10b		5

TMDID a/b interface		Backplane SIVAPAC connector	Connection cable (CABLU)				MDFU-E	Patch Panel RJ45 jack	
No.	Signal	Pin	Color Group	Pair	A-wire	B-wire	Splitting strip	No.	Pin
–	–	24	3	11	black/blue		11a	11	4
	–	25				blue/black	11b		5
–	–	26		12	black/orange		12a	12	4
	–	27				orange/black	12b		5
–	–	29		13	black/green		13a	13	4
	–	30				green/black	13b		5
–	–	31		14	black/brown		14a	14	4
	–	32				brown/black	14b		5
–	–	34		15	black/gray		15a	15	4
	–	35				gray/black	15b		5
–	–	37	4	16	yellow/blue		16a	16	4
	–	38				blue/yellow	16b		5

**Table:** TMDID – Cable and Pin Assignments (Connector Panel with CHAMP Jack, MDFU-E, Patch Panel)

TMDID a/b interface		Backplane CHAMP jack	Connection cable (CABLU)				MDFU-E	Patch Panel RJ45 jack	
No.	Signal	Pin	Color Group	Pair	A-wire	B-wire	Splitting strip	No.	Pin
1	1a	1	1	1	white/blue		1a	1	4
	1b	26				blue/white	1b		5
2	2a	2		2	white/orange		2a	2	4
	2b	27				orange/white	2b		5
3	3a	3		3	white/green		3a	3	4
	3b	28				green/white	3b		5
4	4a	4		4	white/brown		4a	4	4
	4b	29				brown/white	4b		5
5	5a	5		5	white/gray		5a	5	4
	5b	30				gray/white	5b		5

## Boards

### Description of the Boards

TMDID a/b interface		Backplane CHAMP jack	Connection cable (CABLU)				MDFU-E	Patch Panel RJ45 jack		
No.	Signal	Pin	Color Group	Pair	A-wire	B-wire	Splitting strip	No.	Pin	
6	6a	6	2	6	red/blue		6a	6	4	
	6b	31				blue/red	6b		5	
7	7a	7		7	red/orange		7a	7	4	
	7b	32				orange/red	7b		5	
8	8a	8		8	red/green		8a	8	4	
	8b	33				green/red	8b		5	
-	-	9		9	red/brown		9a	9	4	
	-	34				brown/red	9b		5	
-	-	10		10	red/gray		10a	10	4	
	-	35				gray/red	10b		5	
-	-	11	3	11	black/blue		11a	11	4	
	-	36				blue/black	11b		5	
-	-	12		12	black/orange		12a	12	4	
	-	37				orange/black	12b		5	
-	-	13		13	black/green		13a	13	4	
	-	38				green/black	13b		5	
-	-	14		14	black/brown		14a	14	4	
	-	39				brown/black	14b		5	
-	-	15		15	black/gray		15a	15	4	
	-	40				gray/black	15b		5	
-	-	16		4	16	yellow/blue		16a	16	4
	-	41					blue/yellow	16b		5

**Table:** TMDID – Pin Assignments (Connector Panel with 24 RJ45 Jacks)

TMDID a/b interface		Backplane RJ45 jack	
No.	Signal	No.	Pin
1	1a	1	4
	1b		5
2	2a	2	4
	2b		5
3	3a	3	4
	3b		5
4	4a	4	4
	4b		5

TMDID a/b interface		Backplane RJ45 jack	
No.	Signal	No.	Pin
5	5a	5	4
	5b		5
6	6a	6	4
	6b		5
7	7a	7	4
	7b		5
8	8a	8	4
	8b		5
-	-	9	4
	-		5
-	-	10	4
	-		5
-	-	11	4
	-		5
-	-	12	4
	-		5
-	-	13	4
	-		5
-	-	14	4
	-		5
-	-	15	4
	-		5
-	-	16	4
	-		5
-	-	17	4
	-		5
-	-	18	4
	-		5
-	-	19	4
	-		5
-	-	20	4
	-		5
-	-	21	4
	-		5

## Boards

### Description of the Boards

TMDID a/b interface		Backplane RJ45 jack	
No.	Signal	No.	Pin
-	-	22	4
	-		5
-	-	23	4
	-		5
-	-	24	4
	-		5

### 3.2.43 For Selected Countries Only: TMEW2

The TMEW2 (Trunk Module E&M World) board contains four two-way analog tie trunk circuits with E&M signaling for tie traffic with communication systems from other vendors.

#### Board Variants and their Use

Board	Part Number	Used in		Maximum number
		Communication system	Country	
TMEW2	S30810-Q2292-X100	OpenScape Business X8	ROW	Is determined by the system-specific capacity limits.

A SIVAPAC-SIPAC board adapter must be installed in order to be able to use a TMEW2 board in OpenScape Business X8. See [How to Install a SIVAPAC-SIPAC Board Adapter](#)

---

#### **NOTICE:** Fire hazard due to surge voltage

In the case of line lengths exceeding 500 m and where the lines exit the building, the TMEW2 board must be protected by external lightning protection.

Lightning protection of this kind is known as additional primary protection. The additional primary protection is guaranteed by installing ÜSAGs (surge arresters, gas filled) in the main distribution frame, the patch panel or at the entry point of the pipe in the building. A gas-filled surge arrester with 230 V nominal voltage is switched to ground from each wire that is to be protected.

For U.S. and Canada only: The installation regulations require analog trunks to be connected using approved protectors as per UL 497A or CSA C22.2 No. 226.

---

### Main Features

- Each tie trunk has eight connections: two incoming speech paths, two outgoing speech paths, two incoming signaling paths, and two x outgoing signaling paths.
- The board supports interface types 1A and 5 with the Immediate Start, Wink Start, and Delay Dial signaling protocols.  
Before starting up a tie trunk, you must ensure that the two participating communication systems support the same interface types.
- For Thailand only: WBM or Manager E is used to select different impedance/level values. The board must be reset after any change to the impedance/level value.

### Front Panel

To ensure sufficient shielding, the front panel of the board must be provided with a shielding panel.

**Figure:** TMEW2 – LEDs on the Front Panel



### LEDs

The board features a front panel with two LEDs that indicate the operating states.

**Table:** TMEW2 – LED Statuses and their Meanings

Red LED	Green LED	Meaning	Action
off	off	Board not receiving power or not plugged in correctly. Board is out of order.	Check plug contact on board.
on	off	Board is supplied with power. Board test in progress.	–
		Loadware loading failed. Board is faulty.	Replace board.
		Board was deactivated using Manager E.	Check whether the board was deactivated using Manager E. If not, the board is defective and must be replaced.

## Boards

### Description of the Boards

Red LED	Green LED	Meaning	Action
flashing	off	Loadware loading in progress.	–
off	on	Loadware loading completed successfully. Board is OK (idle state).	–
off	flashing	At least one channel is activated.	–

### Cable and Pin Assignments

There are several connection options for tie trunks:

- SIVAPAC connectors are available on the backplane for connecting the external main distribution frame MDFU-E using CABLUs (prefabricated cabling units). See [Table: TMEW2 – Cable and Pin Assignments \(SIVAPAC Connectors on the Backplane, MDFU-E\)](#)
- Connector panels with CHAMP jacks for connecting the external main distribution frame MDFU-E using CABLUs. The connector panels are clipped onto the SIVAPAC connectors on the backplane. See [Table: TMEW2 – Cable and Pin Assignments \(Connector Panel with CHAMP Jack, MDFU-E\)](#)

**Table:** TMEW2 – Cable and Pin Assignments (SIVAPAC Connectors on the Backplane, MDFU-E)

TMEW2 Tie trunk		Backplane SIVAPAC connector	Connection cable (CABLU)				MDFU-E
No.	Signal	Pin	Color Group	Pair	A-wire	B-wire	Splitting strip
1	1ka	1	1	1	white/blue		1a
	1kb	23				blue/white	
2	2ka	3		2	white/orange		2a
	2kb	4				orange/white	
3	3ka	5		3	white/green		3a
	3kb	6				green/white	
4	4ka	7		4	white/brown		4a
	4kb	8				brown/white	
1	1ga	9		5	white/gray		5a
	1gb	10				gray/white	



TMEW2 Tie trunk		Backplane SIVAPAC connector	Connection cable (CABLU)				MDFU-E	
No.	Signal	Pin	Color Group	Pair	A-wire	B-wire	Splitting strip	
2	2ga	11	2	6	red/blue		6a	
	2gb	12				blue/red	6b	
3	3ga	13		7	red/orange		7a	
	3gb	14				orange/red	7b	
4	4ga	15		8	red/green		8a	
	4gb	16				green/red	8b	
1	1E	17		9	red/brown		9a	
	1M	18				brown/red	9b	
2	2E	19		10	red/gray		10a	
	2M	20				gray/red	10b	
3	3E	24		3	11	black/blue		11a
	3M	25					blue/black	11b
4	4E	26	12		black/orange		12a	
	4M	27				orange/black	12b	
1	1SG	29	13		black/green		13a	
	1SB	30				green/black	13b	
2	2SG	31	14		black/brown		14a	
	2SB	32				brown/black	14b	
3	3SG	34	15		black/gray		15a	
	3SB	35				gray/black	15b	
4	4SG	37	4		16	yellow/blue		16a
	4SB	38					blue/yellow	16b

**Boards**

Description of the Boards

**Table:** TMEW2 – Cable and Pin Assignments (Connector Panel with CHAMP Jack, MDFU-E)

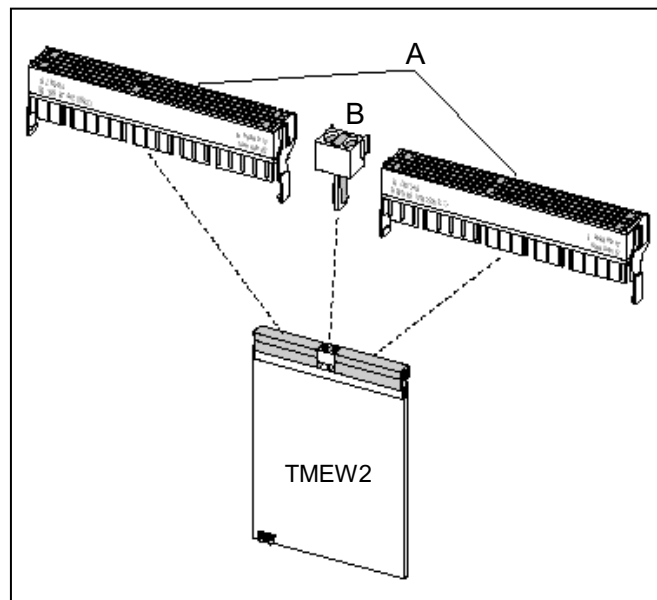
TMEW2 Tie trunk		Backplane CHAMP jack	Connection cable (CABLU)				MDFU-E	
No.	Signal	Pin	Color Group	Pair	A-wire	B-wire	Splitting strip	
1	1ka	1	1	1	white/blue		1a	
	1kb	26				blue/white	1b	
2	2ka	2		2	white/orange		2a	
	2kb	27				orange/white	2b	
3	3ka	3		3	white/green		3a	
	3kb	28				green/white	3b	
4	4ka	4		4	white/brown		4a	
	4kb	29				brown/white	4b	
1	1ga	5		5	white/gray		5a	
	1gb	30				gray/white	5b	
2	2ga	6		2	6	red/blue		6a
	2gb	31					blue/red	6b
3	3ga	7			7	red/orange		7a
	3gb	32					orange/red	7b
4	4ga	8			8	red/green		8a
	4gb	33					green/red	8b
1	1E	9	9		red/brown		9a	
	1M	34				brown/red	9b	
2	2E	10	10		red/gray		10a	
	2M	35				gray/red	10b	
3	3E	11	3		11	black/blue		11a
	3M	36					blue/black	11b
4	4E	12			12	black/orange		12a
	4M	37					orange/black	12b
1	1SG	13			13	black/green		13a
	1SB	38					green/black	13b
2	2SG	14		14	black/brown		14a	
	2SB	39				brown/black	14b	
3	3SG	15		15	black/gray		15a	
	3SB	40				gray/black	15b	
4	4SG	16		4	16	yellow/blue		16a
	4SB	41					blue/yellow	16b

### 3.2.43.1 How to Install a SIVAPAC-SIPAC Board Adapter

A SIVAPAC-SIPAC board adapter must be installed in order to be able to use a TMEW2 board in OpenScape Business X8. The board adapter ensures that the SIVAPAC connector strip of the TMEW2 matches the SIPAC 9 SU connections of the OpenScape Business X8 board slots. The SIVAPAC-SIPAC board adapter consists of three individual parts:

- Two adapter modules [A]
- One startup module [B]

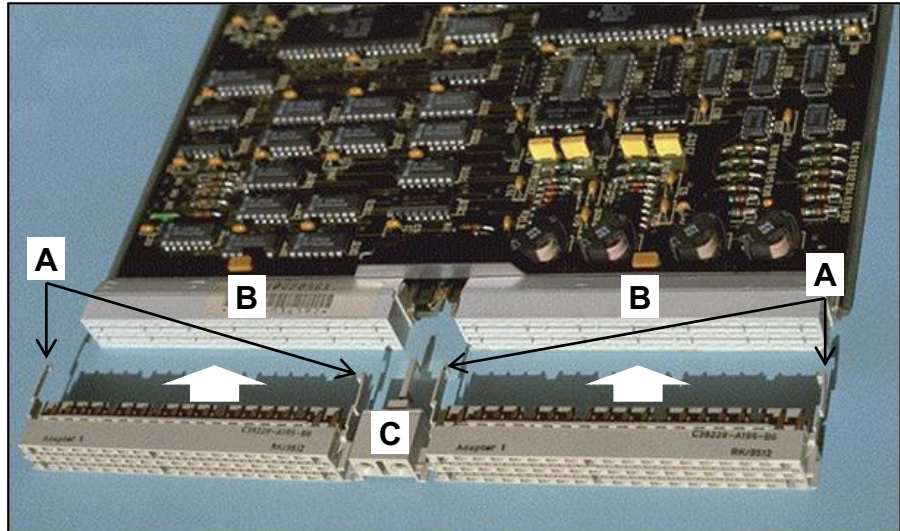
**Figure:** SIVAPAC-SIPAC board adapter



**Step by Step**

- 1) Rotate the TMEW2 board so that the connector strip is pointing towards you.

**Figure:** Installing the SIVAPAC-SIPAC Board Adapter



- 2) Carefully pull the two locking hooks [A] on an adapter module apart.
- 3) Align the adapter module on the connector strip [B] of the board. The outside edges of the adapter module must match the outside edges of the connector strip.
- 4) Make sure that the outermost row of pins on the adapter module and the outermost row of jacks on the connector strip are aligned flush with one another and press the adapter module fully into the connector strip.
- 5) Close the locking hooks.
- 6) Repeat steps 2 to 5 to install the second adapter module.
- 7) Plug the startup module [C] into the hotplug connector on the board.

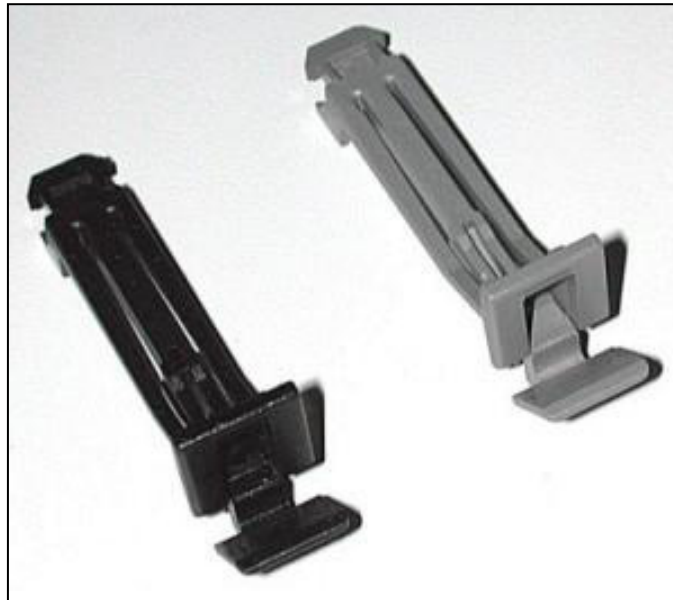
**Next steps**

Installing the SIVAPAC-SIPAC board adapter increases the overall board length. The board juts out slightly further from the board frame. Consequently, in order to lock the board properly, the top black latch must be replaced by the gray latch.

**3.2.43.2 How to Replace a Board Latch**

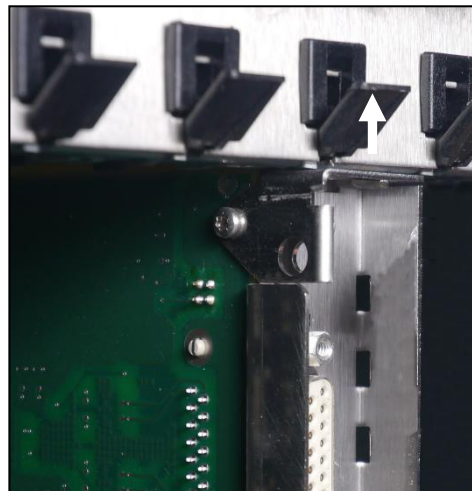
**Figure:** In order to lock a TMEW2 board to the board frame after mounting the SIVAPAC-SIPAC board adapter, the top black board latch must be replaced by a gray latch. The gray board latch takes the increased length of the TMEW2 board

arising from the installation of the board adapter into account. Black and Gray Board Latches



**Step by Step**

- 1) Press the top black board latch at the point marked with the arrow out of its anchor and pull the latch out of the board frame.



- 2) Slide the gray board latch into the board frame and press it firmly into the anchor.

### 3.2.44 Not for U.S.: TS2N, TS2RN

The TS2N and TS2RN (Trunk Module S<sub>2M</sub> New, Rack New) boards each provide one S<sub>2M</sub> interface which can be used for the ISDN trunk connection or for tie-traffic (networking) connections.

## Boards

### Description of the Boards

The B channels of the S<sub>2M</sub> interface are subject to licensing. A license is required for each B channel in order to use it.

The TS2N and TS2RN boards are compatible successor modules for the following boards which cannot be used in the communication systems of the OpenScape Business communication platform for technical reasons:

- TS2 (S30810-Q2913-X100)
- TS2R (S30810-K2913-Z100)

### Board Variants and their Use

Board	Part Number	Used in		Maximum number
		Communication system	Country	
TS2N	S30810-H2913-X300	OpenScape Business X3W OpenScape Business X5W	ROW (not for U.S.)	1
TS2RN	S30810-K2913-Z300	OpenScape Business X3R OpenScape Business X5R	ROW (not for U.S.)	1

---

**NOTICE:** Slot restriction with OpenScape Business X3W/X5W and X3R/X5R

With OpenScape Business X3W/X5W and X3R/X5R, the TS2N and TS2RN boards and may be used only in slots 7 and 9. Only these slots provide the required HDLC channels.

---

---

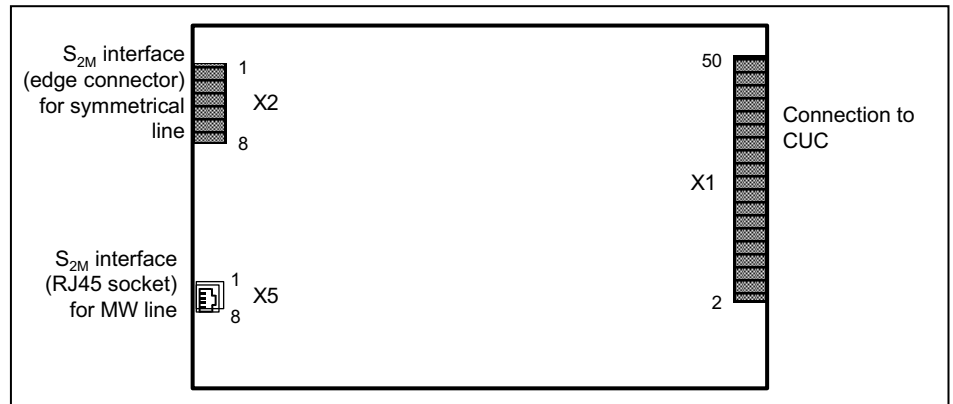
**INFO:** For OpenScape Business X3W, CUX3W must be used as backplane.

For OpenScape Business X3R, CUX3R must be used as backplane.

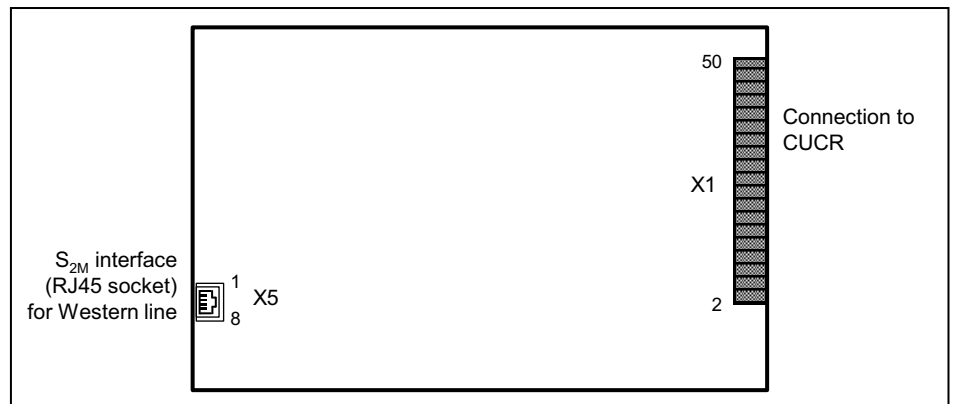
---

**Figure**

**Figure: TS2N**



**Figure: TS2RN**



**Pin Assignments**

**Table: TS2N – Pin Assignment of the Edge Connectors X2**

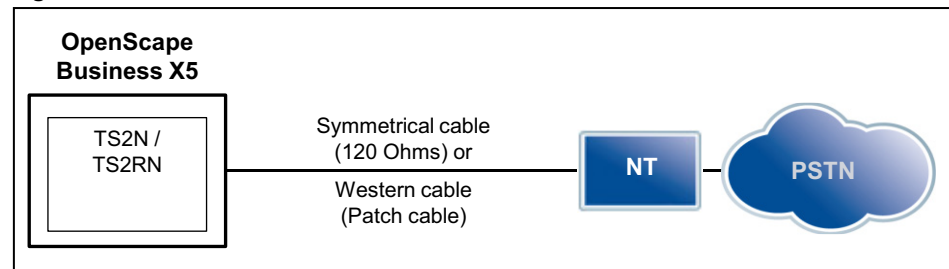
Pin	Function
1	-48 V, max. 15 W (for example, to power a NT)
2	0 V (for example, to power a NT)
3	Ground
4	Board ID for TMCAS
5	A-wire, transmit
6	B-wire, transmit
7	A-wire, receive
8	B-wire, receive

**Table:** TS2N, TS2RN – Pin Assignments of the RJ45 Jack X5

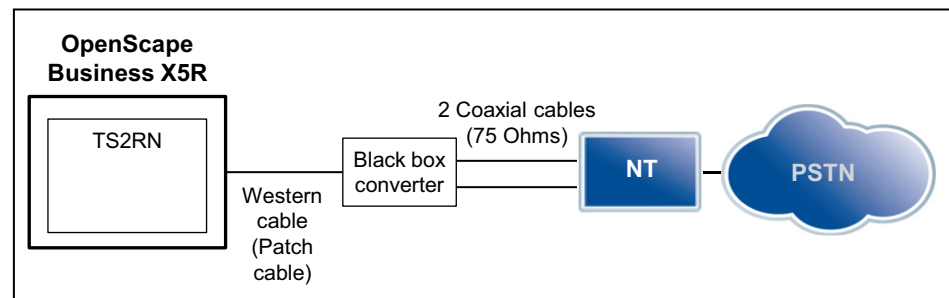
Pin	Function
1	B-wire, receive
2	A-wire, receive
3	Not used
4	B-wire, transmit
5	A-wire, transmit
6	Not used
7	Ground
8	Ground

**ISDN Trunk Connection**

**Figure:** TS2N, TS2RN – ISDN Trunk Connection



**Figure:** TS2RN – ISDN Trunk Connection for Portugal and Spain



The following cable types can be used to connect to the network terminator NT:

- TS2N: symmetrical line (120 ohms) via edge connector X2 or MW line (patch cable) via RJ45 jack X5.
- TS2RN: MW line (patch cable) via RJ45 jack X5 only.

A special connection kit is required for connection to the NT in Spain and Portugal. The connection kit includes a TS2RN board, a black box converter, a MW line (patch cable) and a coaxial line.

The maximum line length depends on the quality of the line used and its signal attenuation. To ensure smooth operation, use only shielded cables.



### 3.2.45 For Selected Countries Only: TST1, TST1R

The TST1 and TST1R (Trunk Module T1, Rack) boards each provide a T1 interface for the trunk connection.

#### Board Variants and their Use

Board	Part Number	Used in		Maximum number
		Communication system	Country	
TST1	S30810-Q2919-X	OpenScape Business X5W	For selected countries only	1
TST1R	S30810-K2919-Z	OpenScape Business X5R	For selected countries only	1

#### Usage and Connection Types

The usage and connection type are defined via the WBM or Manager E.

The following usage types are available:

- T1-PRI trunk connection
- Analog T1 trunk connection

After the usage and connection type have been defined, the board automatically performs a reload to load the loadware for the new settings.

---

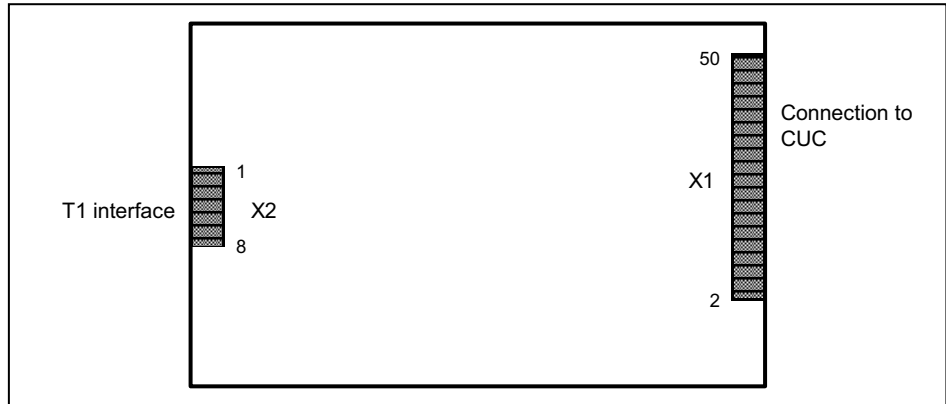
**INFO:** The T1 interface must not be directly connected to the PSTN (Public Switched Telephone Network). At least one Channel Service Unit (CSU) that is approved as per FCC Part 68 and that satisfies the ANSI directive T1.403 must be inserted between the T1 interface and the central office.

The CSU provides the following features for OpenScape Business X5: Isolation and overvoltage protection of the communication system, diagnostic options in the event of a malfunction (such as signal loopback, application of test signals and test patterns), line-up of the output signal in compliance with the line lengths specified by the network provider.

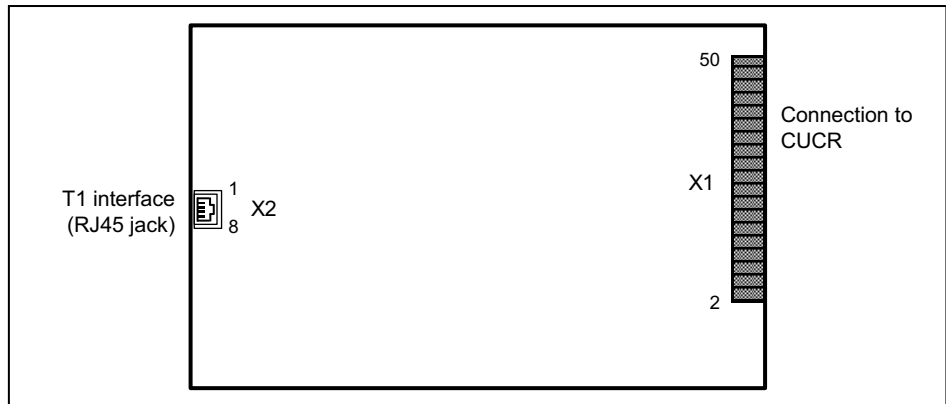
---

**Figure**

**Figure:** TST1



**Figure:** TST1R



**Pin Assignments**

**Table:** TST1, TST1R – Pin Assignments

X2	
Pin	Description
1	B-wire, receive
2	A-wire, receive
3	Not used
4	B-wire, transmit
5	B-wire, transmit
6	Not used
7	Not used
8	Not used

## 3.2.46 UPSC-D

UPSC-D (Uninterruptible Power Supply Com DECT) is the central power supply of the OpenScape Business X3W and OpenScape Business X5W communication systems.

UPSC-D supports power supply and battery management functions. No other components are required if it is operated as a power supply. To maintain short-term battery emergency operation after a power failure, that is, to use uninterruptible power supply functions, you must connect an additional OpenScape Business Powerbox (with a 48-V/7-Ah battery pack).

UPSC-D is only released for permanent operation in an AC grid. Permanent operation in a DC network is not allowed. Connection to a DC supply (48 V battery pack or 48 VDC power) must only be employed for short-term battery emergency operation after a power failure. In this scenario, the use of the 48-V/7-Ah battery pack is preferred.

---

**NOTICE:** Damage to property owing to surge voltage

If a 48-V DC network is used instead of a 48-V/7-Ah battery pack to maintain short-term battery emergency operation after a power failure, the connection requirements are the same as for the connection of the battery pack. During normal operation, when charging the batteries or in the event of an error, the 48-V DC network must not exceed the maximum voltage of 60 V. The direct-current system must not be connected to the UPSC-D if this cannot be guaranteed.

---

In large system configurations, the power output of the UPSC-D may be insufficient and thus require the use of an auxiliary power source via an external power supply. In such cases, an OpenScape Business Powerbox should be used (with LUNA2 as external power supply).

Possible use cases for OpenScape Business Powerbox with OpenScape Business X3W and OpenScape Business X5W:

- Use as an uninterruptible power supply  
OpenScape Business Powerbox equipped with four 12V 7Ah batteries (48V 7Ah battery pack)  
The UPSC-D is used for charging the batteries in the OpenScape Business Powerbox.  
Only the 48V 7Ah battery pack (with four 12V 7Ah batteries, V39113-W5123-E891) is released for connection to the UPSC-D.

---

**INFO:** Battery packs with voltages < 35 V (tolerance range: 33 V to 37 V) are not charged by the UPSC-D. This ensures that operating a low-voltage battery pack (e.g., a 24 V battery pack) or a faulty battery pack is not possible at the UPSC-D.

---

## Boards

### Description of the Boards

- Use as auxiliary power supply  
OpenScape Business Powerbox equipped with a LUNA2 as external power supply  
Connect the DC output on the OpenScape Business Powerbox to the -48 VDC input on the UPSC-D. The UPSC-D's -48-Vdc output is deactivated when the external power supply is connected.
- Use as auxiliary power supply and uninterruptible power supply  
OpenScape Business Powerbox is equipped with
  - a LUNA2 as external power supply.  
Connect the DC output on the OpenScape Business Powerbox to the -48 VDC input on the UPSC-D. The UPSC-D's -48-Vdc output is deactivated when the external power supply is connected.
  - four 12V 7Ah batteries (48V 7Ah battery pack).  
The LUNA2 is used for charging the batteries in the OpenScape Business Powerbox.  
Only the 48V 7Ah battery pack (with four 12V 7Ah batteries, V39113-W5123-E891) is released for connection to the UPSC-D.

---

**INFO:** Battery packs with voltages < 35 V (tolerance range: 33 V to 37 V) are not charged by the UPSC-D. This ensures that operating a low-voltage battery pack (e.g., a 24 V battery pack) or a faulty battery pack is not possible at the UPSC-D.

---

### Board Variants and their Use

Board	Part Number	Used in		Maximum number
		Communication system	Country	
UPSC-D	S30122-K5660-X301	OpenScape Business X3W OpenScape Business X5W	ROW	1

### Technical Data

- Nominal voltage range: 100 VAC - 240 VAC
- Nominal frequency: 50 Hz - 60 Hz
- Ring voltage generator: 75 VAC, 20/25/50 Hz
- Output voltages: +5 VDC, -48 VDC
- Battery charging voltage, if UPSC-D is used as a battery charger: 40.8 VDC - 55.2 VDC
- Power consumption: 180 W
- Bridging times (for emergency battery operation in the event of power failure):  
The maximum bridging times given in the following table are basic orientation values. The actual values may vary depending on the system configuration.

**Table:** UPSC-D – Bridging Times

Communication system	Load levels	Maximum bridging time
OpenScape Business X3W with UPSC-D OpenScape Business Powerbox equipped with four 12V 7Ah batteries	Normal output load 100 % = 5 V and 3 A / –48 V and 0.5 A ringing approx. 2 VA	Approx. 3 hours
OpenScape Business X5W with UPSC-D OpenScape Business Powerbox equipped with four 12V 7Ah batteries	Normal output load 60 % = 5 V and 4.8 A / –48 V and 0.66 A ringing approx. 2 VA	Approx. 2.5 hours
Measurement conditions: All measurements were performed at a room temperature of approximately 23 °C (73.4 °F). The batteries were fully charged when the measurement was started.		

**Figure**

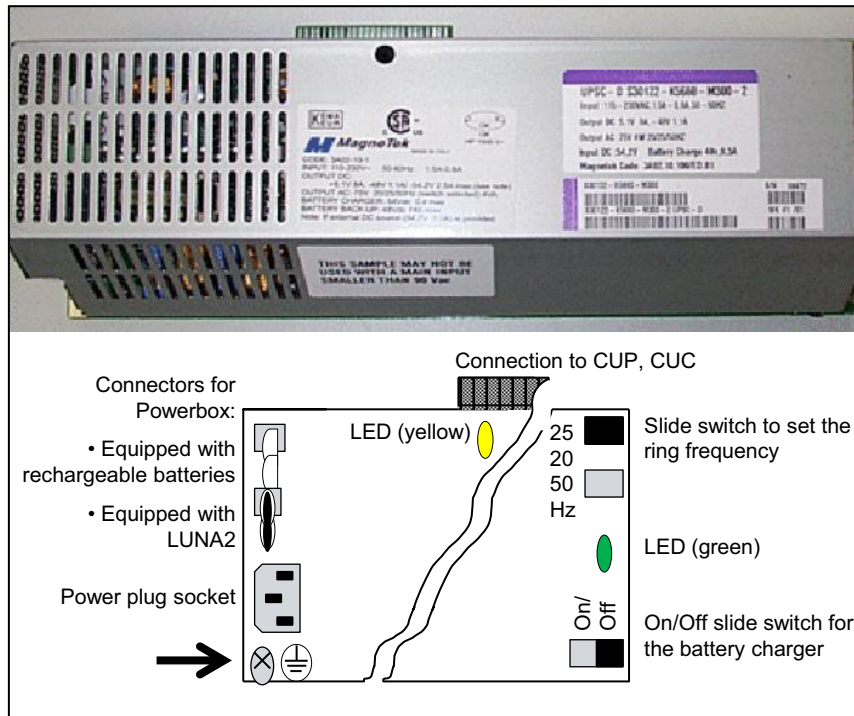


**WARNING**

**Risk of electric shock through contact with live wires**

The screw marked with an arrow in the figure below performs the ground connection between UPSC-D and the housing of the communication system and must always be installed.

**Figure:** UPSC-D



**LEDs**

The board features two LEDs that indicate the following operating states:

- LED, green: +5-Vdc output voltage is available
- LED, yellow: -48 VDC voltage is supplied by the external power supply (OpenScape Business Powerbox equipped with LUNA2).

**Switches**

The board features two slide switches with the following functions.

**Table:** UPSC-D – Switches and their Functions

Switches	Switch position	Meaning
Switch for activating and deactivating the battery charging voltage	ON	UPSC-D works as a battery charger (supplies charging voltage).
	OFF	UPSC-D does not supply charging voltage.

Switches	Switch position	Meaning
Switch for setting the ring frequency	25 Hz	UPSC-D provides a ring frequency of 25 Hz (setting for Germany and international markets).
	20 Hz	UPSC-D provides a ring frequency of 20 Hz (setting for the U.S.).
	50 Hz	UPSC-D provides a ring frequency of 25 Hz (setting for France).



**WARNING**

**Risk of electric shock through contact with live wires**

The OpenScape Business X3W and OpenScape Business X5W communication systems must be switched off/on by pulling/reconnecting the power plug.

Disconnect all the communication system's power plugs and make sure that the communication system is not supplied by another power source (uninterrupted power supply unit, for instance) if the scheduled maintenance work requires the communication system to be in a de-energized state.

### 3.2.47 UPSC-DR

UPSC-DR (Uninterruptible Power Supply Com DECT Rack) is the central power supply of the OpenScape Business X3R and OpenScape Business X5R communication systems.



---

**WARNING**

**Risk of electric shock through contact with live components**

The UPSC-DR board is not insulated.

For this very reason, the OpenScape Business X3R and OpenScape Business X5R communication systems must only be operated with a closed housing.

Before opening the housing, make sure that the communication system is de-energized as follows:

- by disconnecting the battery voltage, supply voltage (LUNA2) and line voltage at any connected OpenScape Business Powerbox.
- by disconnecting the line cords attached to any connected OpenScape Business Powerbox.
- by disconnecting the line cords of any connected battery pack or any connected batteries.
- by disconnecting the power plug of the communication system.

---

UPSC-DR supports power supply and battery management functions. No other components are required if it is operated as a power supply. To maintain short-term battery emergency operation after a power failure, that is, to use uninterruptible power supply functions, you must connect an additional OpenScape Business Powerbox (with a 48-V/7-Ah battery pack).

UPSC-DR is only released for permanent operation in a AC network. Permanent operation in a DC network is not allowed. Connection to a DC supply (48 V battery pack or 48 VDC power) must only be employed for short-term battery emergency operation after a power failure. In this scenario, the use of the 48-V/7-Ah battery pack is preferred.

---

**NOTICE:** Damage to property owing to surge voltage

If a 48-V DC network is used instead of a 48-V/7-Ah battery pack to maintain short-term battery emergency operation after a power failure, the connection requirements are the same as for the connection of the battery pack. During normal operation, when charging the batteries or in the event of an error, the 48-V DC network must not exceed the maximum voltage of 60 V. If this cannot be guaranteed, the DC network must not be connected to the UPSC-DR!

---

In large system configurations, the power output of the UPSC-DR may be insufficient and thus require the use of an auxiliary power source via an external power supply. In such cases, an OpenScape Business Powerbox should be used (with LUNA2 as external power supply).

Possible use cases for OpenScape Business Powerbox with OpenScape Business X3R and OpenScape Business X5R:



- Use as an uninterruptible power supply  
OpenScape Business Powerbox equipped with four 12V 7Ah batteries (48V 7Ah battery pack)  
The UPSC-DR is used for charging the batteries in the OpenScape Business Powerbox.  
Only the 48V 7Ah battery pack (with four 12V 7Ah batteries, V39113-W5123-E891) is released for connection to the UPSC-DR.

---

**INFO:** Battery packs with voltages < 35 V (tolerance range: 33 V to 37 V) are not charged by the UPSC-DR. This ensures that operating a low-voltage battery pack (e.g., a 24 V battery pack) or a faulty battery pack is not possible at the UPSC-DR.

---

- Use as auxiliary power supply  
OpenScape Business Powerbox equipped with a LUNA2 as external power supply  
Connect the DC output on the OpenScape Business Powerbox to the -48 VDC input on the UPSC-DR. The UPSC-DR's -48-Vdc output is deactivated when the external power supply is connected.
- Use as auxiliary power supply and uninterruptible power supply  
OpenScape Business Powerbox is equipped with
  - a LUNA2 as external power supply.  
Connect the DC output on the OpenScape Business Powerbox to the -48 VDC input on the UPSC-DR. The UPSC-DR's -48-Vdc output is deactivated when the external power supply is connected.
  - four 12V 7Ah batteries (48V 7Ah battery pack).  
The LUNA2 is used for charging the batteries in the OpenScape Business Powerbox.  
Only the 48V 7Ah battery pack (with four 12V 7Ah batteries, V39113-W5123-E891) is released for connection to the UPSC-DR.

---

**INFO:** Battery packs with voltages < 35 V (tolerance range: 33 V to 37 V) are not charged by the UPSC-DR. This ensures that operating a low-voltage battery pack (e.g., a 24 V battery pack) or a faulty battery pack is not possible at the UPSC-DR.

---

### Board Variants and their Use

Board	Part Number	Used in		Maximum number
		Communication system	Country	
UPSC-DR	S30122-K7373-X901	OpenScape Business X3R OpenScape Business X5R	ROW	1

**Technical Data**

- Nominal voltage range: 100 VAC - 240 VAC
- Nominal frequency: 50 Hz - 60 Hz
- Ring voltage generator: 75 VAC, 20/25/50 Hz
- Output voltages: +5 VDC, -48 VDC
- Battery charging voltage, if UPSC-DR is used as a battery charger: 40.,8 VDC - 55.2 VDC
- Power consumption: 180 W
- Bridging times (for emergency battery operation in the event of power failure):  
The maximum bridging times given in the following table are basic orientation values. The actual values may vary depending on the system configuration.

**Table:** UPSC-DR – Bridging Times

Communication system	Load levels	Maximum bridging time
OpenScape Business X3R with UPSC-DR  OpenScape Business Powerbox equipped with four 12V 7Ah batteries	Normal output load 100 % =  5 V and 3 A / -48 V and 0.5 A  ringing approx. 2 VA	Approx. 3 hours
OpenScape Business X5R with UPSC-DR  OpenScape Business Powerbox equipped with four 12V 7Ah batteries	Normal output load 100 % =  5 V and 8 A / -48 V and 1.1 A  ringing approx. 4 VA	Approx. 1.5 hours
Measurement conditions:  All measurements were performed at a room temperature of approximately 23 °C (73.4 °F).  The batteries were fully charged when the measurement was started.		

**Figure**

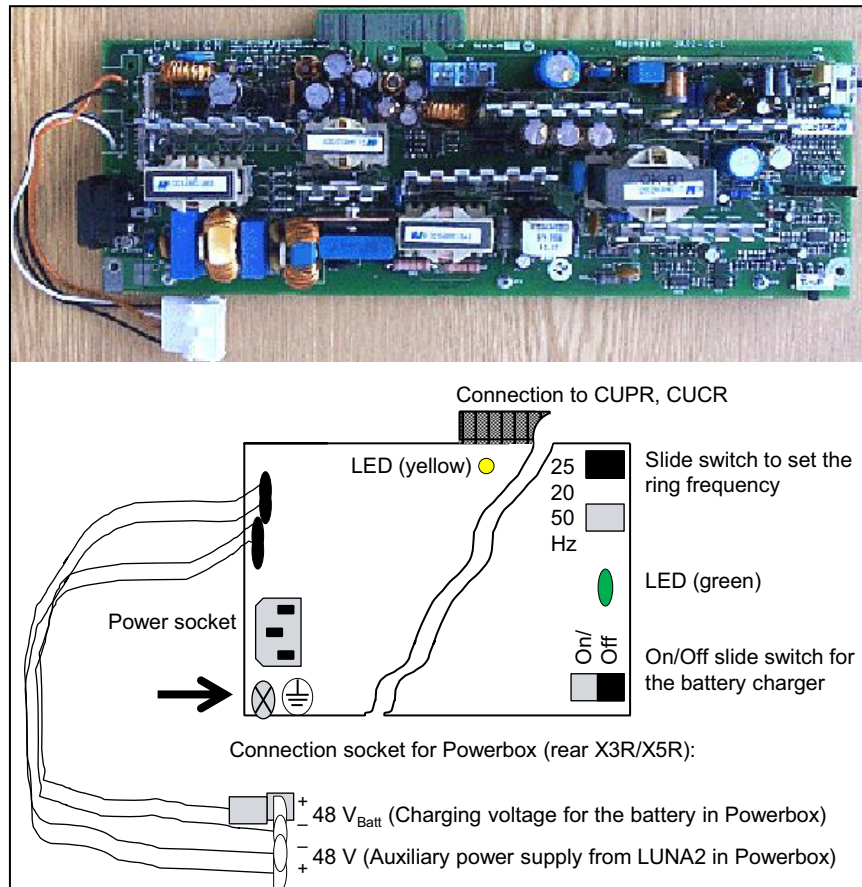


**WARNING**

**Risk of electric shock through contact with live wires**

The screw marked with an arrow in the figure below performs the ground connection between UPSC-DR and the 19-inch rack housing of the communication system and must always be installed.

**Figure:** UPSC-DR



### LEDs

The board features two LEDs that indicate the following operating states:

- LED, green: +5-Vdc output voltage is available
- LED, yellow: -48 VDC voltage is supplied by the external power supply (OpenScape Business Powerbox equipped with LUNA2).

### Switches

The board features two slide switches with the following functions.

## Boards

### Description of the Boards

**Table:** UPSC-DR – Switches and their Functions

Switches	Switch position	Meaning
Switch for activating and deactivating the battery charging voltage	ON	UPSC-DR works as a battery charger (supplies charging voltage).
	OFF	UPSC-DR does not supply charging voltage.
Switch for setting the ring frequency	25 Hz	UPSC-DR provides a ring frequency of 25 Hz (setting for Germany and international markets).
	20 Hz	UPSC-DR provides a ring frequency of 20 Hz (setting for the U.S.).
	50 Hz	UPSC-DR provides a ring frequency of 25 Hz (setting for France).



#### **WARNING**

##### **Risk of electric shock through contact with live wires**

The OpenScape Business X3R and OpenScape Business X5R communication systems must be switched off/on by pulling/reconnecting the power plug.

Disconnect all the communication system's power plugs and make sure that the communication system is not supplied by another power source (uninterrupted power supply unit, for instance) if the scheduled maintenance work requires the communication system to be in a de-energized state.

## 4 Extensions

This section describes the supplementary equipment and extensions that are not part of the standard installation of the OpenScape Business X3/X5/X8 communication systems.

### 4.1 Installing the Hardware of the OpenScape Business Powerbox

The 19" rack mount case of the OpenScape Business Powerbox can be used as an uninterruptible power supply and as an auxiliary power supply for OpenScape Business X3/X5/X8 communication systems.

**Figure:** OpenScape Business Powerbox



#### **OpenScape Business X3/X5: Possible Use Cases for the OpenScape Business Powerbox**

---

**INFO:** When using OCPSM as power supply unit for OpenScape Business X3/X5, the OpenScape Business Powerbox should not be used. Powerbox as additional Power supply will be covered by the OCPSM itself.

---

- Use as an uninterruptible power supply  
OpenScape Business Powerbox equipped with four 12-V/7-Ah batteries (48-V/7-Ah battery pack)  
The charging of batteries in the OpenScape Business Powerbox occurs through the power supply of the communication system (UPSC-D for OpenScape Business X3W/X5W, UPSC-DR for OpenScape Business X3R/X5R).  
Only the 48V 7Ah battery pack (with four 12V 7Ah batteries, V39113-W5123-E891) is released for connection to the UPSC-D and the UPSC-DR.

---

**INFO:** Battery packs with voltages < 35 V (tolerance range: 33 V to 37 V) are not charged by the UPSC-D and the UPSC-DR. This ensures that operating a low-voltage battery pack (e.g., a 24 V

## Extensions

### Installing the Hardware of the OpenScape Business Powerbox

battery pack) or a faulty battery pack is not possible at the UPSC-D and the UPSC-DR.

---

- Use as additional power supply  
OpenScape Business Powerbox equipped with a LUNA2 as external power supply. Using the LUNA2 increases the nominal power output at the -48V output to 110 watts (LUNA2 works in the operation mode 2a and supplies a voltage of 54.7V.).  
The DC output of the OpenScape Business Powerbox is connected to the -48VDC input of the communication system's power supply (UPSC-D for OpenScape Business X3W/X5W and UPSC-DR for OpenScape Business X3R/X5R). The -48 VDC output of the communication system's power supply is deactivated when the external power supply is connected.
- Use as additional power supply and uninterruptible power supply  
OpenScape Business Powerbox is equipped with
  - a LUNA2 as an external power supply. Using the LUNA2 increases the nominal power output at the -48V output to 110 watts (LUNA2 works in the operation mode 2a and supplies a voltage of 54.7V.).  
The DC output of the OpenScape Business Powerbox is connected to the -48VDC input of the communication system's power supply (UPSC-D for OpenScape Business X3W/X5W and UPSC-DR for OpenScape Business X3R/X5R). The -48 VDC output of the communication system's power supply is deactivated when the external power supply is connected.
  - four 12-V/7-Ah batteries (48-V/7-Ah battery pack).  
The LUNA2 is used for charging the batteries in the OpenScape Business Powerbox.  
Only the 48V 7Ah battery pack (with four 12V 7Ah batteries, V39113-W5123-E891) is released for connection to the UPSC-D and the UPSC-DR.

---

**INFO:** Battery packs with voltages < 35 V (tolerance range: 33 V to 37 V) are not charged by the UPSC-D and the UPSC-DR. This ensures that operating a low-voltage battery pack (e.g., a 24 V battery pack) or a faulty battery pack is not possible at the UPSC-D and the UPSC-DR.

---

### OpenScape Business X8: Possible Use Cases for the OpenScape Business Powerbox

The OpenScape Business Powerbox is used as an uninterruptible power supply. One OpenScape Business Powerbox is required for each system box of the communication system. The following options are available:

- OpenScape Business Powerbox equipped with four 12-V/7-Ah batteries (48-V/7-Ah battery pack)  
The batteries are charged via the redundant LUNA2 in the respective system box.  
Only the 48V 7Ah battery pack (with four 12V 7Ah batteries, V39113-W5123-E891) is released for use in the OpenScape Business Powerbox.

- OpenScape Business Powerbox equipped with four 12V 7Ah batteries (48V 7Ah battery pack) and one LUNA2 power supply  
Battery charging occurs through the LUNA2 in the OpenScape Business Powerbox (LUNA2 works in the operation mode 2a and supplies a voltage of 54.7V.).  
Only the 48V 7Ah battery pack (with four 12V 7Ah batteries, V39113-W5123-E891) is released for use in the OpenScape Business Powerbox.

### 4.1.1 Construction Data

The dimensions and weight of the OpenScape Business Powerbox are specified below, with and without the batteries and the LUNA2 power supply.

Dimensions:

- Height: approx. 155 mm
- Width: approx. 440 mm
- Depth: approx. 380 mm
- Height units for 19" rack-mount installation: 4

Weight:

- Empty weight: approx. 7.0 kg
- Total weight (equipped with four 12V 7Ah batteries and LUNA2): 21.0 kg
- Battery compartment with four 12V 7Ah batteries: approx. 12.0 kg
- Single 12V 7Ah battery: approx. 2.65 kg
- Power supply LUNA2: approx. 2.0 kg

### 4.1.2 Controls, Indicators and Connections

On the front panel and on the rear side of the OpenScape Business Powerbox, there are switches to turn on and turn off the power supply and output voltages. An LED on the front panel displays the operating status of the LUNA2. The rear panel offers various connectivity options and access to four fuses.

**Extensions**

Installing the Hardware of the OpenScape Business Powerbox

**Front Panel**

**Figure:** OpenScape Business Powerbox – Front panel



No.	Control/Indicator
1	LED for displaying the LUNA2 operating status: <ul style="list-style-type: none"> <li>Flashing:                             <ul style="list-style-type: none"> <li>At least one secondary power supply is outside the tolerance range. The supply of power from the LUNA2 is insufficient. LUNA2 is defective.</li> </ul> </li> </ul>
2	Secondary power switch (LUNA2): <ul style="list-style-type: none"> <li>On: LUNA2 provides secondary power.</li> <li>Off: LUNA2 does not provide secondary power.</li> </ul>
3	Mains switch: <ul style="list-style-type: none"> <li>On: OpenScape Powerbox is supplied with mains voltage.</li> <li>Off: OpenScape Powerbox is not supplied with mains voltage.</li> </ul>

**Rear panel**

**Figure:** OpenScape Business Powerbox – Rear side of housing





No.	Connection / Control / Fuse	
1	Output voltage: Connector for the power cable to the communication system	
2	Line input: Connects for the power cord of the OpenScape Business Powerbox	
3	Fan switch: This switch is not used.	
4	Fuse F1 (2.5 A/T): Protection for X1 output	
5	X1 connector: This connector is not used.	
6	Fuse F2 (2.5 A/T): Protection for X2 output	
7	X2 connector:	
	OpenScape Business Powerbox equipped with four 12V 7Ah batteries: <ul style="list-style-type: none"> <li>• No connector</li> </ul>	OpenScape Business Powerbox equipped with four 12V 7Ah batteries and one LUNA2 power supply: <ul style="list-style-type: none"> <li>• Connector for the C39195-A7985-B24 connection cable to the OpenScape Business X3R/X5R communication system</li> <li>• Connector for the C39195-A7985-B37 connection cable to the OpenScape Business X3W/X5W communication system</li> </ul>
8	Fuse F3 (16 A/T): Protection for X3 output	
9	X3 connector:	
	OpenScape Business Powerbox equipped with four 12V 7Ah batteries: <ul style="list-style-type: none"> <li>• No connector</li> </ul>	OpenScape Business Powerbox equipped with four 12V 7Ah batteries and one LUNA2 power supply: <ul style="list-style-type: none"> <li>• Connector for the C39195-A7985-B24 connection cable to the OpenScape Business X3R/X5R communication system</li> <li>• Connector for the C39195-A7985-B37 connection cable to the OpenScape Business X3W/X5W communication system</li> <li>• Connector for the C39195-Z7985-B11 connection cable to the OpenScape Business X8 communication system</li> </ul>

## Extensions

### Installing the Hardware of the OpenScape Business Powerbox

No.	Connection / Control / Fuse	
10	X7 connector:	
	OpenScape Business Powerbox equipped with four 12V 7Ah batteries: <ul style="list-style-type: none"> <li>• No connector</li> </ul>	OpenScape Business Powerbox equipped with four 12V 7Ah batteries and one LUNA2 power supply: <ul style="list-style-type: none"> <li>• Port for the C39195-A7985-B38 connection cable to the XBatt connector</li> </ul>
11	XBatt connector:	
	OpenScape Business Powerbox equipped with four 12V 7Ah batteries: <ul style="list-style-type: none"> <li>• Connector for the C39195-A7985-B24 connection cable to the OpenScape Business X3R/X5R communication system</li> <li>• Connector for the C39195-A7985-B37 connection cable to the OpenScape Business X3W/X5W communication system</li> <li>• Connector for the C39195-Z7985-B11 connection cable to the OpenScape Business X8 communication system</li> </ul>	OpenScape Business Powerbox equipped with four 12V 7Ah batteries and one LUNA2 power supply: <ul style="list-style-type: none"> <li>• Port for the C39195-A7985-B38 connection cable to the X7 connector</li> </ul>
12	XBatt switch (DC switch):	
	<ul style="list-style-type: none"> <li>• On: OpenScape Powerbox provides power at the XBatt output.</li> <li>• Off: OpenScape Powerbox does not provide power at the XBatt output.</li> </ul>	
13	Fuse F4 (16 A/T):	
	Protection for XBatt output	

## 4.1.3 Components

The orderable components of OpenScape Business Powerbox are described here.

- OpenScape Business Powerbox (empty housing): S30177-U773-X
- Mounting kit for 19" rack mount: C39165-A7027-D1
- Mounting kit for wall mounting and standalone installation (desktop): C39165-A7027-D2
- 12V 7Ah battery: V39113-W5123-E891
- LUNA2 power supply: S30122-H7686-X1
- Power cord (country-specific): C39195-Z7001-Cxx
- Connection cable for OpenScape Business X3R/X5R:
  - OpenScape Business Powerbox equipped with four 12V 7Ah batteries: C39195-A7985-B24

- OpenScape Business Powerbox equipped with four 12V 7Ah batteries and one LUNA2 power supply: C39195-A7985-B24, C39195-A7985-B38
- Connection cable for OpenScape Business X3W/X5W:
  - OpenScape Business Powerbox equipped with four 12V 7Ah batteries: C39195-A7985-B37
  - OpenScape Business Powerbox equipped with four 12V 7Ah batteries and one LUNA2 power supply: C39195-A7985-B37, C39195-A7985-B38
- Connection cable for OpenScape Business X8:
  - OpenScape Business Powerbox equipped with four 12V 7Ah batteries: C39195-A7985-B11
  - OpenScape Business Powerbox equipped with four 12V 7Ah batteries and one LUNA2 power supply: C39195-Z7985-B11, C39195-A7985-B38

#### 4.1.4 OpenScape Business Powerbox with Batteries and/or LUNA2 Power Supply

When the OpenScape Business Powerbox is equipped with four 12V 7Ah batteries (48V 7Ah battery pack) and/or the LUNA2 power supply, it can be used as an uninterruptible power supply and/or an auxiliary power supply for the OpenScape Business X3/X5/X8 communication systems.

**Figure:** OpenScape Business Powerbox – Equipped with four 12V 7Ah batteries and LUNA2 power supply



## Extensions

### Installing the Hardware of the OpenScape Business Powerbox

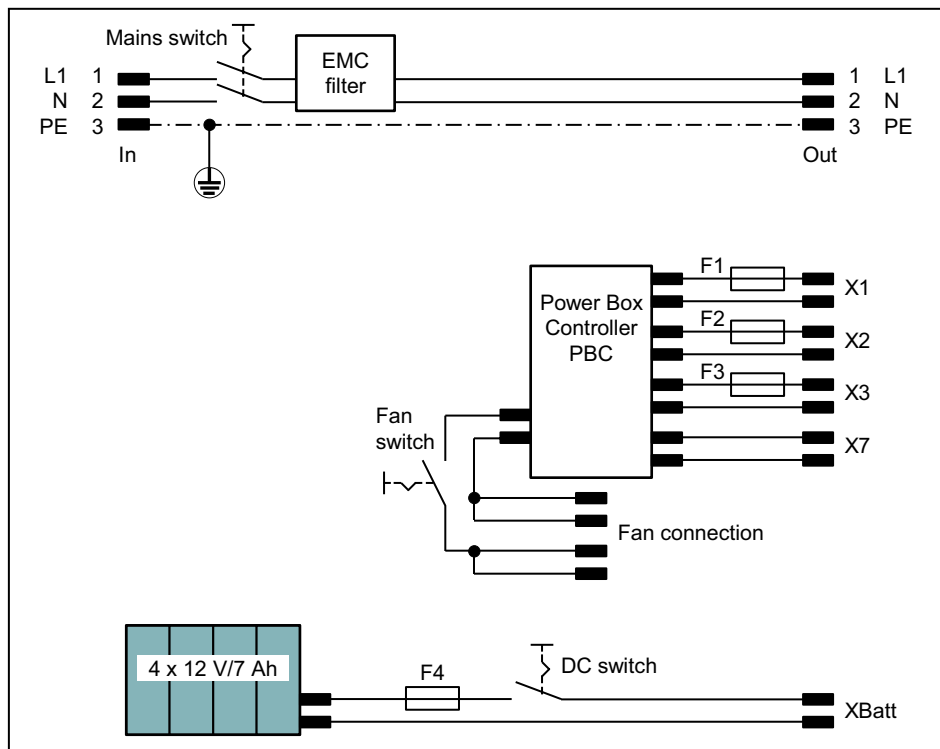
**NOTICE:** When storing an OpenScape Business Powerbox equipped with batteries or during prolonged periods of non-operation, the F4 fuse (protection for XBatt output) must be removed.

To avoid transport damage, the OpenScape Business Powerbox must not be transported with the batteries installed.

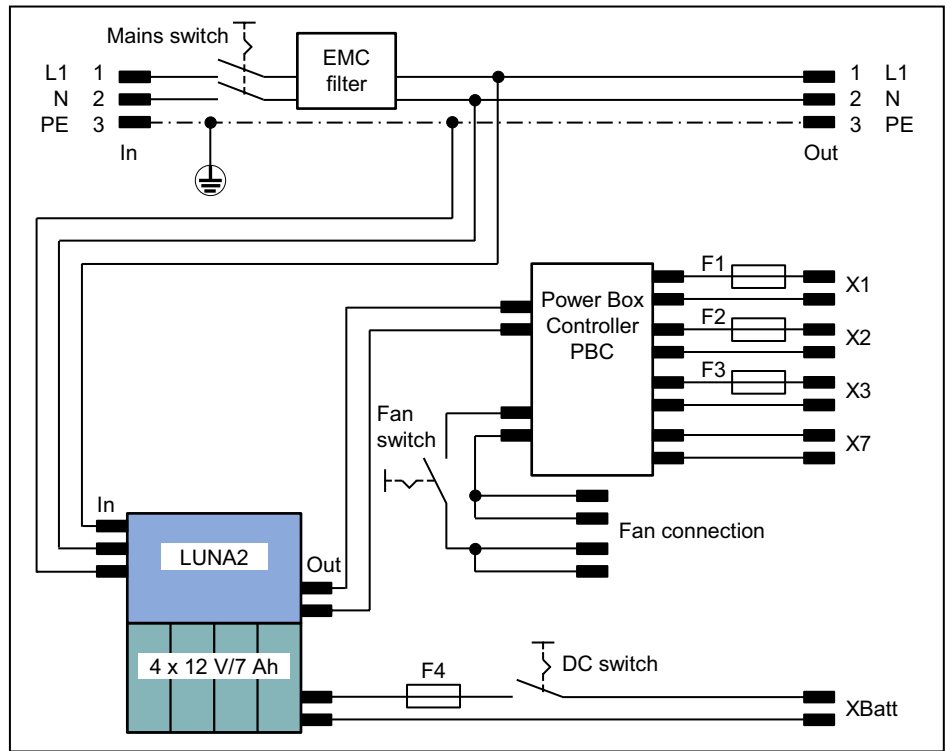
## Block Diagrams

The following block diagrams show the wiring within the OpenScape Business Powerbox.

**Figure:** OpenScape Business Powerbox – Block diagram with four 12V 7Ah batteries



**Figure:** OpenScope Business Powerbox – Block diagram with four 12V 7Ah batteries and LUNA2 power supply



## 5 Integrated Cordless Solution

OpenScape Business Cordless is the integrated cordless solution for operating cordless telephones (DECT phones) via the communication system. The HFA features of OpenScape Business can then be used with the connected DECT phones.

In the integrated cordless solution, the DECT phones are internal, system-specific stations as opposed to separate DECT systems, which are connected via standard interfaces.

The connection of OpenScape Business base stations for the operation of DECT phones can be implemented via:

- For OpenScape Business X1/X3/X5: direct connections to the U<sub>P0/E</sub> interfaces of the mainboard of the communication system (DECT Light)
- For OpenScape Business X3/X5: connection to the U<sub>P0/E</sub> interfaces of an SLU8N/SLU8NR board (DECT Light)
- For OpenScape Business X5W: connection to the U<sub>P0/E</sub> interfaces of the SLC16N board

---

**INFO:** Slot 10 (slot level 5) is no longer supported in X5W system with part Number S30777-U777-X711.

SLC16N card has been phased out.

---

- For OpenScape Business X8: connection to the U<sub>P0/E</sub> interfaces of an SLMUC (SLMU + CMAe) or SLCN board

The Cordless radio technology corresponds to the DECT (Digital Enhanced Cordless Telecommunications) Standard. The entire radio area administered by the system is made up of base stations, which together form either a complete network of overlapping radio cells or individual radio "islands". The size of a radio cell is dependent on the local/structural factors.

### ECO Mode

In ECO mode (economic mode), the transmit power of DECT phones is either reduced by a fixed value (static) or every DECT phone adjusts its transmit power independently to the received signal strength (adaptive). ECO mode can be enabled at the communication system on a system-wide basis for all DECT phones (**Expert Mode > Telephony > Cordless > System-wide**). No configuration is required at the DECT telephones. A manual system restart is needed to activate the feature in case of OpenScape Business X1, X3, X5

- Static adjustment of transmit power  
The DECT phones and base station reduce the transmit power to a set fixed value.
- Adaptive adjustment of transmit power  
The DECT phones transmit with normal or reduced transmit power, depending on the reception field strength. During a handover, the system first

switches to the high transmit power and then reduces the transmit power, depending on the reception.

### DECT phones

The integrated Cordless solution supports GAP-enabled mobile telephones from third-party manufacturers. The full scope of HFA services can, however, only be used with approved DECT phones.

### Configuration

For a description of the configuration, see *Configuring the Integrated Cordless Solution*.

### Boards and Base Stations

The descriptions of the boards and base stations can be found in the *Boards* chapter.

## 5.1 System Overview

The connection of the OpenScape Business base stations for OpenScape Business X3/X5 occurs either directly at the  $U_{P0/E}$  interfaces of the mainboard or at the  $U_{P0/E}$  interfaces of an installed SLU8N/SLU8NR board (DECT Light). With OpenScape Business X5W/X8, the base stations can be connected to the Cordless SLC boards if SLC16N and SLCN boards are still supported, else DECT Light is used for X5W systems and SLMUC (SLMU + CMAe) is used for X8 systems.

### Direct Connections (DECT Light)

The base stations can be connected directly to the  $U_{P0/E}$  interfaces of the central control boards [OCCMR](#) and [OCCM](#) of the OpenScape Business X3R/X3W and OpenScape Business X5R/X5W communication systems or to the  $U_{P0/E}$  interfaces of an SLU8N/SLU8NR8 board.

By using the CMA/CMAe subboard on the central control boards OCCMR and OCCM, the ADPCM conversion and echo cancellation functions (16 channels for CMA and 48 channels for CMAe) are made available. Up to four calls can be conducted per base station. Up to seven base stations can be connected to the  $U_{P0/E}$  interfaces of the central control boards OCCM and OCCMR. The mixed use of base stations of the types BS3/4 and BS5 is possible.

If no CMA/CMAe is installed, a maximum of two calls can be conducted per base station. In this case, the ADPCM conversion is performed directly by the DECT base station.

When connecting base stations to an SLU8N/SLU8NR board, the following connectivity requirements apply:

- In total, a maximum of 15 base stations (7 at the mainboard and 8 more at an SLU8N/SLU8NR board) can be operated. The maximum number of connectable DECT telephones is 32 with a CMA and 64 with a CMAe.

- Only one SLU8N/SLU8NR board can be used for the connection of base stations.
- Only the first port on the base station can be used to connect of the base station to a U<sub>P0/E</sub> interface of the SLU8N/SLU8NR board. The second port of the base station is not supported for connection to a further U<sub>P0/E</sub> interface.
- The U<sub>P0/E</sub> interfaces of the SLU8N/SLU8NR board can be used with a mixed combination of base stations and/or telephones.

### Connecting Cordless Boards

The base stations BS3/1, BS3/3, BS4 and BS5 can be connected to the U<sub>P0/E</sub> interfaces of the following Cordless boards:

- SLC16N with OpenScape Business X5W

---

**INFO:** Slot 10 (slot level 5) is no longer supported in X5W system with part Number S30777-U777-X711.  
SLC16N has been phased out.

---

- SLCN with OpenScape Business X8 (see SLCN chapter)
- SLMUC (SLMU + CMAe) with OpenScape Business X8 (see SLMUC chapter)

The connection of the base stations can be made via one, two or three U<sub>P0/E</sub> interfaces. In case of an SLMU last 8 interfaces can only be used as 2nd or 3rd U<sub>P0</sub> interface of the base station.

The additional connection of U<sub>P0/E</sub> interfaces

- increases the traffic capacity of the base station and thus the number of simultaneously available voice channels
- increases the supply range of the connected base station and thus enables the use of longer cables

The mixed deployment of the listed base station types at the listed Cordless boards is possible.

## 5.1.1 System Configuration

Depending on the communication system, up to 64 base stations can be connected, and up to 250 DECT phones can be used.

The following table shows the maximum possible system configuration for the integrated cordless solution and indicates in which cases analog trunk access of the communication system is possible.

---

**NOTICE:** The base stations BS4 (S30807-U5491-X), BS3/1 (S30807-H5482-X), BS3/3 (S30807-H5485-X) and BS3/S (X30807-X5482-X100) are being phased out and can no longer



be ordered. However, they can still be connected to OpenScape Business X communication systems.

In the event of a failure, the current base stations should be used.

---

**INFO:** If no CMA/CMAe is installed, a maximum of two calls can be conducted per base station. In this case, ADPCM conversion is performed directly by the DECT base station, but echo cancellation is not directly supported. In case that echo cancellation is required a CMA/CMAe subboard is needed.

---



---

**INFO:** In the following table, the combination of SLMU card plus CMAe module is referred as SLMUC.

---

OpenScape Business	Maximum number of boards				Clock Module	Max. number of BaseStation BS when connected via 1xU <sub>P0</sub>	Ports/Simultaneous calls per BS	Max. number of registred devices	Max. number of simultaneous calls
	SLC16N	SLCN	SLUN	SLMUC					
X1	–	–	–	–	–	7	1/2	16	14
	–	–	–	–	CMA	7	1/4	16	16
	–	–	–	–	CMAe	7	1/4	16	16
X3 Onboard U <sub>P0/E</sub> (SLUC)	–	–	–	–	–	7	1/2	32	16
	–	–	–	–	CMA	7	1/4	32	16
	–	–	1	–	CMA	15	1/4	32	16
	–	–	–	–	CMAe	7	1/4	64	28
	–	–	1	–	CMAe	15	1/4	64	48
X5 Onboard U <sub>P0/E</sub> (SLUC)	–	–	–	–	–	7	1/2	32	16
	–	–	–	–	CMA	7	1/4	32	16
	–	–	1	–	CMA	15	1/4	32	16
	–	–	–	–	CMAe	7	1/4	64	28
	–	–	1	–	CMAe	15	1/4	64	48
X5W	1	–	–	–	–	16	3/12	64	32*
X8	–	4	–	–	–	64	3/12	250 (128 per SLCN)	128**
	–	–	–	4	CMAe	64	3/12	250 (128 per SLCN)	192***

\* Max. value per SLCN16 is 32. In case of roaming the ADPCM conversion is always done on the SLC16N board where the handset is currently located. Therefore the number of simultaneous calls per system could be higher than 32, if the handset is located on the visiting SLC16N

\*\* The max. value per SLCN is 32. Depending on the location of the handsets in case of roaming, theoretically all devices that are registered (250) could be active if 4 SLCN cards are available.

\*\*\* SLCN and SLMUC can be merged within one system. The max. value is 32 per SLCN and 48 per SLMUC. Depending on the location of the handsets in case of roaming, theoretically all devices that are registered (250) could be active if 4 SLCN / SLMUC in sum are available.

## 5.1.2 Power-Related Capacity Limits

The number of base stations, their distance from the communication system, and the overall telephone configuration determine whether or not the output from the internal system power supply units is sufficient or, in case of systems with UPSD D/DR, whether an auxiliary power supply via the OpenScope Business Powerbox is necessary.

For more information on the power requirements of a communication system, see [Power Requirements of a Communication System](#).

## 5.1.3 Traffic capacity

The traffic capacity inside different radio cells (for example, in offices, warehouses or garage areas) varies according to the subscribers.

The following tables provide reference values for the traffic capacity of individual base stations. These values apply to a single radio cell not having overlapping ranges with other radio cells (without overload handling).

A distinction is made here, depending on whether the connection of the base station occurs via one  $U_{P0/E}$  interface (= four simultaneously available voice channels), two  $U_{P0/E}$  interfaces (= eight simultaneously available voice channels) or three  $U_{P0/E}$  interfaces (= 12 simultaneously available voice channels) of a Cordless board.

**Table:** Traffic capacity of single base stations with 50 mErl per subscriber

	Connecting the base station					
	1 x $U_{P0/E}$		2 x $U_{P0/E}$		3 x $U_{P0/E}$	
Grade Of Service (GOS)	0.1 %	1 %	0.1 %	1 %	0.1 %	1 %
Number of stations per base station	11	16	42	62	84	118
Traffic capacity	0.55 erlangs	0.8 erlangs	2.1 erlangs	3.1 erlangs	4.2 erlangs	5.9 erlangs

**Table:** Traffic capacity of single base stations with 100 mErl per subscriber

	Connecting the base station					
	1 x U <sub>P0/E</sub>		2 x U <sub>P0/E</sub>		3 x U <sub>P0/E</sub>	
Grade Of Service (GOS)	0.1 %	1 %	0,1 %	1 %	0,1 %	1 %
Number of stations per base station	7	8	21	31	42	59
Traffic capacity	0.7 erlangs	0.8 erlangs	2.1 erlangs	3.1 erlangs	4.2 erlangs	5.9 erlangs

**Table:** Traffic capacity of single base stations with 200 mErl per subscriber

	Connecting the base station					
	1 x U <sub>P0/E</sub>		2 x U <sub>P0/E</sub>		3 x U <sub>P0/E</sub>	
Grade Of Service (GOS)	0.1 %	1 %	0.1 %	1 %	0.1 %	1 %
Number of stations per base station	4	5	10	15	21	29
Traffic capacity	(0.8 erlangs)	1 erlangs	2.1 erlangs	3.1 erlangs	4.2 erlangs	5.9 erlangs

## 5.1.4 Grade Of Service (GOS)

The Grade of Service indicates the availability (i.e., successful setup) and loss (i.e., the termination) of call connections in cordless solutions.

To calculate the capacity limits, the following assumptions are made: 1 % GOS per radio interface and 0.1 % on the PCM highway of the communication system and on the networking connections. A GOS of 1 % for availability means that an average of one call out of 100 cannot be made. For a call from handset to handset, 1 % GoS per radio interface means that an average of two calls out of 100 (2 %) cannot be made.

Radio field quality and the number of available channels are crucial elements for setting up a call and for call breakdowns in cordless connections. Poor radio field quality results in high breakdown rates, low availability, and poor voice quality. This may occur if the physical structure of buildings (a lot of metal, machinery, tin, etc.) causes inhomogeneous fields and reflections. In such cases, a GOS of 1% or 2% cannot be achieved. The interference described can also occur when using other DECT devices (such as cordless headsets or cordless phones).

## 5.1.5 Multi-SLC

Multi-SLC offers the full mobility of DECT stations across all Cordless boards within a communication system (OpenScape Business X8) and across all communication systems in a network (OpenScape Business X3/X5/X8).

**Multi-SLC within a communication system**

You can install up to four SLCUC (SLMU + CMAe) or SLCN boards in OpenScape Business X8. For the total DECT station mobility (roaming and seamless connection handover) within a communication system, the radio areas of these cordless boards are synchronized.

If there are not SLMUC, SLCN or SLC16N boards and OpenScape Business network is plugged on U<sub>P0/E</sub>, a CMA or CMAe module is needed on the control board in case of an OpenScape Business network with CMI roaming over the nodes.

Each DECT phone is seen as a corded phone by the communication system. During administration, a fixed port on the system's "home cordless board" is assigned to the DECT phone; this is used for addressing the DECT phone.

As soon as a DECT phone moves into the area of a different radio switching location ("current-location cordless board"), an extension connection is switched using a DSS1 connection initiated by the cordless board. The home and current-location cordless boards exchange a networking protocol (User-to-User Signaling UUS) over this extension connection to support full mobility.

**Multi-SLC in a network**

Multi-SLC can also be used across systems (across nodes) because the SIP-Q protocol used for networking supports the UUS protocol. That means full mobility across the radio areas of the different Cordless systems. All DECT phone features (callback, team functions, Voicemail, etc.) remain intact. The network-wide handover feature is the only exception here, since it is not supported.

As a precondition, the radio areas of the networked communication systems must not overlap.

**Required B Channels for Multi-SLC**

DECT phone has set up a connection	Required B channels	Required B channels for the home cordless board	Required B channels on the transitional cordless board
In the home cordless board range	1	1	–
In the transitional cordless board range	3	2	1
Handover from home to home cordless boards	1	1	–
Handover from home to transitional cordless board	3	2	1
Handover from transitional to transitional cordless board	5 (temporary)	3	2 (one for each cordless board)

Additional B channels using fixed connection paths (SIP-Q) may be required for the system-wide extension connections (Multi-SLC in a network).

## 5.1.6 Single-Cell Mode

Single-cell mode allows up to 8 DECT telephones that are registered together to a base station and are in one call group to ring simultaneously. Only one B channel is occupied in the process. The DECT phone that answers the call uses this B channel. The single-cell mode is only supported for DECT Light. Only one base station (BS3/S, BS4 or BS5) may be connected to a U<sub>P0/E</sub> interface of the OCCM/OCCMR mainboard.

By contrast, in the multi-cell mode (when more than one base station is connected), the number of DECT phones that can ring simultaneously is equal to the number of free B-channels. This restriction does not apply in single-cell mode (when only one base station is connected), since only one B-channel is used.

---

**INFO:** The system automatically switches from single-cell mode to multi-cell mode if an additional BS5 base station is connected or if a BS4 or BS3/S base station is replaced with a BS5 base station and more BS5 base stations are additionally connected. In these cases, the first BS5 base station automatically restarts and switches to multi-cell mode.

The switch from multi-cell mode back to single-cell mode requires a manually initiated system restart after the additional base stations have been removed.

---

## 5.1.7 Network-wide Roaming

The 'network-wide roaming' feature enables DECT users to move between the radio coverage areas of networked communication systems.

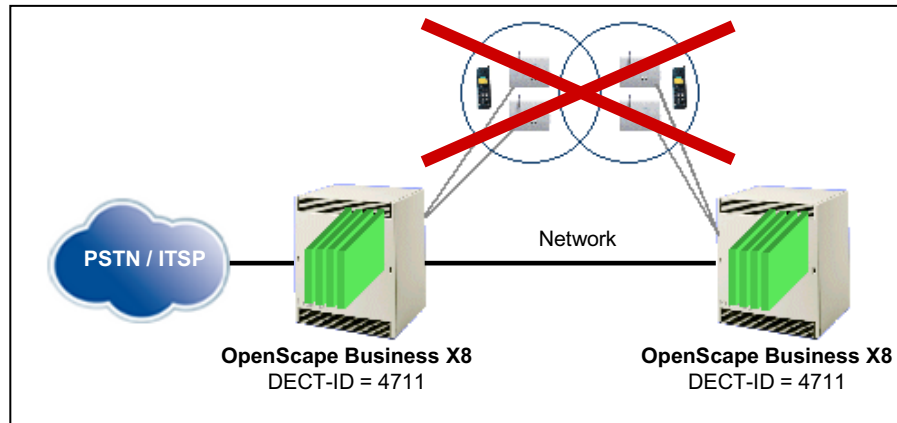
When using this feature, please ensure that there is no overlapping in the radio areas of individual communication systems with identical DECT IDs. Networked communication systems with identical DECT IDs are viewed as a single system by the DECT phone.

If the radio areas of communication systems with identical DECT IDs overlap, the mobile DECT phones inadvertently try to perform network wide handover, which results in communication breakdown.

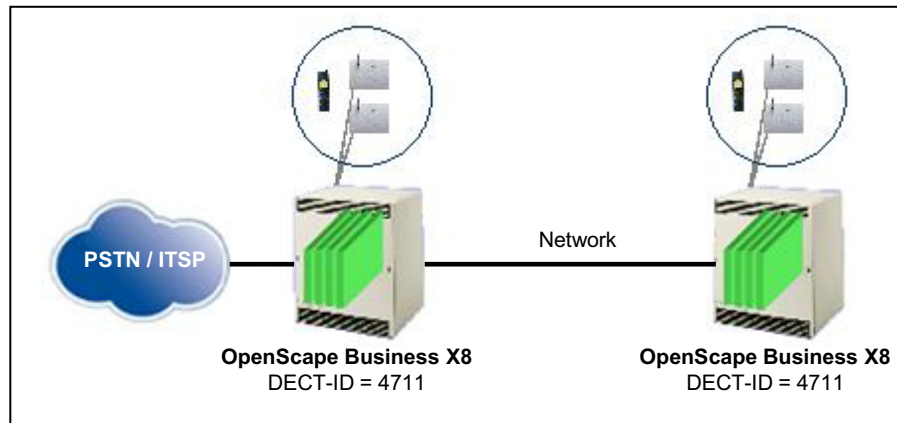
If networking is required for communication systems in which the individual radio areas overlap (for example, to increase capacity limits or through decentralized installation), different DECT IDs must be configured in the individual systems. Network-wide roaming is not supported in this case.

Examples of scenarios involving networked communication systems:

- Scenario 1: Correct DECT configuration of networked communication systems  
Identical DECT IDs and overlapping radio areas result in incorrect handover causing a breakdown in communication.



- Scenario 2: Permissible DECT configuration of networked communication systems  
No incorrect handover despite identical DECT IDs as the radio areas do not overlap. Network-wide roaming possible.



### 5.1.8 Clock Supply

The synchronization clock for the Cordless boards is generated by the master Cordless board. Frame synchronization is performed for the connected base stations using this clock signal.

## 5.2 Base Station BS5

Base stations make up a network of radio cells and conduct the communication with DECT phones.

The base station BS5 (S30807-U5497-X) is available for the connection to OpenScape Business X.

The base stations BS4 (S30807-U5491-X), BS3/1 (S30807-H5482-X), BS3/3 (S30807-H5485-X) and BS3/S (X30807-X5482-X100) will continue to be supported. However, these base stations are being phased out and can no longer be ordered.

## 5.2.1 Technical Data

The technical data provides information on the operating conditions for the BS5 base station.

	<b>BS5</b>
Power supply voltage range	42 to 54 V
Maximum power consumption	3.0 W
Housing dimensions (length x width x depth)	202 x 172 x 43 mm
Weight	Approx. 0.5 kg
Temperature range	- 5 to + 45 °C (when operating indoors)
	- 20 to 50 °C (when operating outdoors with the outdoor housing)
Maximum humidity	95 %
Direct connection	1 x $U_{P0/E}$
Board connection	1 x or 2 x or 3 x $U_{P0/E}$

Figure: Base Station BS5



## 5.2.2 Pin Assignments

The connection of the BS5 base station at the  $U_{P0/E}$  interface of a mainboard (direct connection) or a Cordless board (board connection) occurs via the connector strip X1.

If the base station is connected via one  $U_{P0/E}$  interface of a Cordless board, four voice channels are available simultaneously. Similarly, if connected via two  $U_{P0/E}$  interfaces or three  $U_{P0/E}$  interfaces, either eight or twelve voice channels are available simultaneously.

Each connection to a  $U_{P0/E}$  interface is made via a pair of wires of the connection cable.

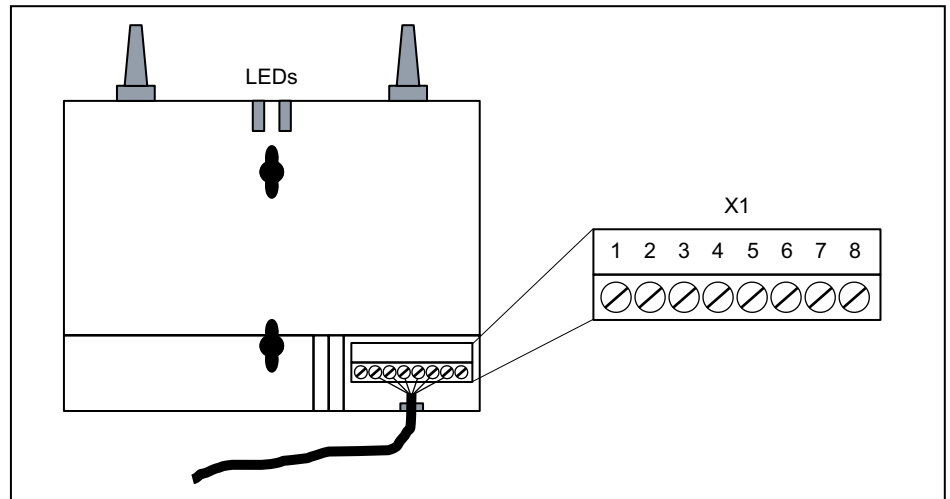
---

**NOTICE:** A base station may not be supplied by different Cordless boards.

---



**Figure:** Rear View - Terminal Strip X1



**Table:** Pin Assignments of Terminal Strip X1

Connection	Port	Description	
		Direct connection	Board connection
1	–	Not used	
2	U <sub>P0/E</sub> port 0	Connection of a U <sub>P0/E</sub> interface	
3		<b>NOTE:</b> This port must always be connected!	
4	U <sub>P0/E</sub> port 1	It is not possible to connect a further U <sub>P0/E</sub> interface.	Connection of a second U <sub>P0/E</sub> interface
5			
6	U <sub>P0/E</sub> port 2	It is not possible to connect a further U <sub>P0/E</sub> interface.	Connection of a third U <sub>P0/E</sub> interface
7			
8	–	Not used	
The connector strip is polarized.			

After connecting the first U<sub>P0/E</sub> interface, the base station BS5 is ready for use.

## 5.2.3 LEDs

The front panel of the BS5 base station features two LEDs that indicate the operating states.

**Table:** Information on LED displays for BS5

LED 1	LED 2	State	Comment
red	red	Board is in reset state	During boot-up
blue	off	FPGA is loaded, boot starts	During boot-up
white	white	BIST is running	During boot-up

LED 1	LED 2	State	Comment
Blinking yellow: Encryption on Blinking red: Encryption off	blue	Parameter download	
	light dimly violet	T-Bit request	
	brightly violet	T-Bit received	Switch to normal operation, if phase difference < 50ppm
red	off	Selftest of base station	
		(at major error BS remains in this condition)	
blinking red	off	Boot-Firmware is running	
		-no loadware in BS	
		-waiting for loadware download	
		-download of new LW is currently underway	
blinking red	blue	-BS ready (working with LW), but parameter download and synchronization is missing	
twice flashing red	blue	-BS ready, but all frequencies are blocked (RFP does not send)	
off	blue	-BS synchronized and sends Dummy bearer, but no slot active	
off	blinking blue	-BS synchronized and one slot active at least	
red	blinking blue	-BS in overload	
off	twice flashing blue	-DNS, slave BS is searching for master BS (not synchronous to master system)	
blinking red	blinking blue (synchronous to other LED)	CTR6 testmode	
		Note: Layer 1 has to be established at port 0	
blinking	blinking blue (alternatingly with other LED)	Loopback # 2 (2B+D) for biterror-measurement	
	dark blue	1x UP0E connected	During operational mode
	white	2x UP0E connected	During operational mode
	light blue	3x UP0E connected	During operational mode

## 5.2.4 Operating Range

The operating range determines the maximum possible length of the connection cable from the communication system (Cordless board) to a base station.

The operating range depends on

- the signal range, which is determined by the type of connection cable used.
- the supply range, which is determined by the connection of the base station to the Cordless board, the nature of the supply to the base station, and the type of connection cable used.

The lower range of both values determines the operating range. For example, if the signal range is less than the supply range, the signal range corresponds to the operating range.

---

**INFO:** If there are free  $U_{P0/E}$  interfaces available at a Cordless board, these should be used for additional connections to the existing base stations. Besides increasing the supply range, this also enables higher traffic capacity at the base stations.

---

### Signal range

The following two tables show the signal range of different cable types for indoor and outdoor use.

---

**INFO:** In case of an SLMU board, the cable length to the base station must not be more than 800 m.

---

**Table:** Signal range of various installation cable types

Cable type	Wire insulation material	Signal range
Installation cable:		
J-2YY ...x 2 x 0.6 / 1.4 VIMF FR ICCS (V45480-D ..6-K5-86)	100% PE	1400 m
J-2Y(ST)Y < 10 x 2 x 0.6 STIIIBD	100% PE	1300 m
J-2Y(ST)Y ≥ 10 x 2 x 0.6 STIIIBD	100% PE	2000 m
Installation cable < 10 x 2 x 0.6:		
J-Y(ST) 2 x 2 x 0.6 LG	PVC	1000 m
J-YY 2 x 2 x 0.6 BD	PVC	1000 m
J-H(ST)H 2 x 2 x 0.6 BD FR NC	Halogen-free	1000 m
Installation cable ≥ 10 x 2 x 0.6:		
J-Y(ST)Y ≥ 10 x 2 x 0.6 LG	PVC	1300 m
J-YY ≥ 10 x 2 x 0.6 BD	PVC	1300 m
J-H(ST)H ≥ 10 x 2 x 0.6 BD FR NC	Halogen-free	1300 m

Cable type	Wire insulation material	Signal range
Installation cable < 10 x 2 x 0.8:		
J-Y(ST)Y 2 x 2 x 0.8 LG	PVC	1000 m
J-YY 2 x 2 x 0.8 BD	PVC	1000 m
J-H(ST)H 2 x 2 x 0.8 BD FR NC	Halogen-free	1000 m
JE-H(ST)H 2 x 2 x 0.8 BD FR NCX	Halogen-free	1000 m
Installation cable ≥ 10 x 2 x 0.8:		
J-Y(ST)Y ≥ 10 x 2 x 0.8 LG	PVC	1800 m
J-YY ≥ 10 x 2 x 0.8 BD	PVC	1800 m
J-H(ST)H ≥ 10 x 2 x 0.8 BD FR NC	Halogen-free	1800 m
JE-H(ST)H ≥ 10 x 2 x 0.8 BD FR NCX	Halogen-free	1800 m

**Table:** Signal range of various outdoor cable types

Cable type	Wire insulation material	Signal range
External cable < 10 x 2 x 0.6 STIIIIBD:		
A-2Y(L)2Y < 10 x 2 x 0.6 STIIIIBD 1PPERF	100% PE	1500 m
A-2YF(L)2Y < 10 x 2 x 0.6 STIIIIBD	100% PE, filled	1500 m
A-2Y0F(L)2Y < 10 x 2 x 0.6 STIIIIBD	100% PE, filled	1500 m
A-02Y0F(L)2Y < 10 x 2 x 0.6 STIIIIBD	100% PE, filled	1500 m
External cable ≥ 10 x 2 x 0.6 STIIIIBD:		
A-2Y(L)2Y ≥ 10 x 2 x 0.6 STIIIIBD 1PPERF	100% PE	2000 m
A-2YF(L)2Y ≥ 10 x 2 x 0.6 STIIIIBD	100% PE, filled	2000 m
A-2Y0F(L)2Y ≥ 10 x 2 x 0.6 STIIIIBD	100% PE, filled	2000 m
A-02Y0F(L)2Y ≥ 10 x 2 x 0.6 STIIIIBD	100% PE, filled	2000 m
External cable ≥ 10 x 2 x 0.8 STIIIIBD:		
A-2Y(L)2Y ≥ 10 x 2 x 0.8 STIIIIBD 1PPERF	100% PE	2400 m
A-2YF(L)2Y ≥ 10 x 2 x 0.8 STIIIIBD	100% PE, filled	2400 m
A-2Y0F(L)2Y ≥ 10 x 2 x 0.8 STIIIIBD	100% PE, filled	2400 m

Cable type	Wire insulation material	Signal range
A-02Y0F(L)2Y ≥ 10 x 2 x 0.8 STIIIBD	100% PE, filled	2400 m
External cable ... x 2 x 0.4:		
A2Y(L)2Y... x 2 x 0.4	100% PE	1400 m
A-2YF(L)2Y ... x 2 x 0.4 STIIIBD	100% PE, filled	1400 m
Paper-insulated external cable:		
A-PM ... x 2 x 0.6 STIIILG or BD	Paper	2400 m
A-PM ... x 2 x 0.8 STIIILG	Paper	3200 m

### Supply Range

The following table lists the supply range of the BS5 base station when using connection cables with a wire diameter of 0.6 mm, depending on the connection.

**Table:** Supply ranges

Connection via	Power consumption of the BS5	Supply range for connection cables with a wire diameter of 0.6 mm
1 x U <sub>P0/E</sub>	2.0 W	1000 m
2 x U <sub>P0/E</sub>	2.5 W	2000 m
3 x U <sub>P0/E</sub>	3.0 W	3000 m

---

**INFO:** When connecting via two U<sub>P0/E</sub> interfaces and a connection cable with a wire diameter of 0.6 mm, the supply range of the BS5 base station is approximately 2000 m, which should be sufficient for most installations.

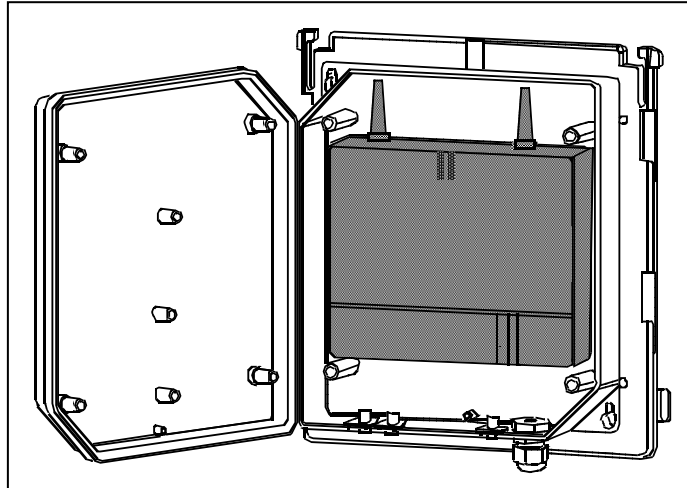
---

## 5.2.5 Outdoor Housing

The weatherproof outdoor housing S30122-X7469-X2 protects the base station BS5 mounted therein and allows the use of the base station in outdoor areas. A heater is not required.

The outdoor cover is suitable for mounting on wooden, concrete or brick walls, roofs, and masts.

**Figure:** Outside Housing S30122-X7469-X2 with Base Station BS5

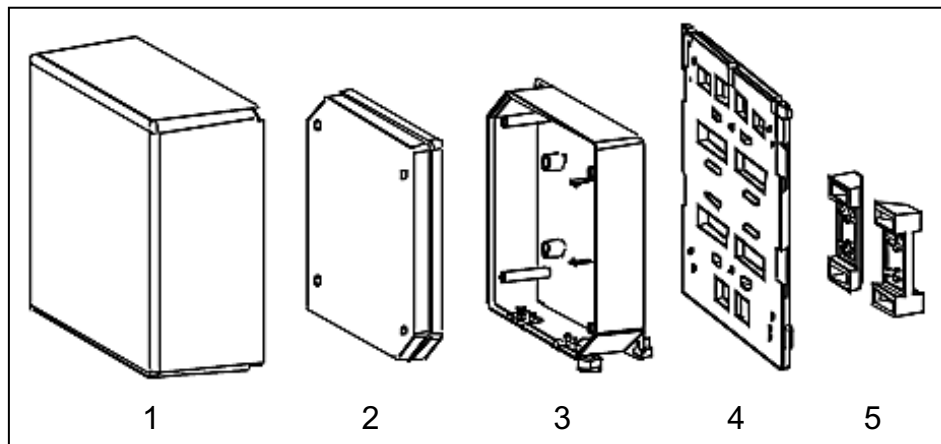


### Outdoor Housing Components

The outdoor cover consists of the following components:

- Sun shade [1]
- Housing cover [2]
- Housing base [3]
- Mounting plate [4]
- Mast blocks [5]

**Figure:** Outdoor Housing Components



---

**INFO:** For special cases, e.g., for the use of base stations in cold stores, special outdoor housing enclosures must be used. This enables operation within the ambient temperature range of -40 to 50 °C.

This outdoor housing is manufactured and sold by the company Dirk Ritter ([www.excom-ritter.de](http://www.excom-ritter.de)), for example.

---

## 5.3 Project Planning Guidelines for a Cordless Solution

When planning for a cordless solution, it must be noted that the positions of the base stations are crucial for performance.

### 5.3.1 Considering the Volume of Traffic

A number of special requirements must be considered when planning a cordless solution for areas with high traffic volumes (volume of calls).

To cover an increased volume of traffic, the intended base station should be equipped with the maximum number of U<sub>P0E</sub> connections (using three U<sub>P0E</sub> interfaces) instead of installing additional base stations, since every switch from one base station to another in the call state (handover) generates additional load.

The best base station should be as unique as possible to avoid frequent switching of the base station in the call state.

In borderline scenarios (with 17 to 20 U<sub>P0/E</sub> ports required for base stations, for instance), one Cordless board may suffice if radio coverage is skillfully arranged or if special antennas are used.

In communication systems with multiple Cordless boards, the radio areas of all base stations connected to a Cordless board (Cordless board area) should be regarded as separate. The following information applies:

- Minimum overlapping between Cordless board areas. To increase the user number in a Cordless board area, the area should be decreased rather than allowing it to overlap with another area.
- All DECT phones are assigned to Cordless board areas that they predominantly occupy. This cordless board is the home cordless board of the DECT phone. This is where the DECT subscriber logs in.

A particularly high load occurs when changing the cordless board area.

### 5.3.2 Considering the Propagation Conditions for Radio Traffic

Radio wave propagation in the DECT frequency range is quasi-optical. This means that a wave is hindered in its propagation if it hits a solid surface and is thereby reflected to a greater or lesser extent. This reflection is dependent on the physical qualities of the medium. In the case of conductive materials, the penetration depth into the medium is determined mainly by the magnetic quality and the electrical conductivity.

#### Highly Conductive Metals

Highly conductive metals such as copper or steel prevent most DECT frequency radio waves from penetrating, reflecting them in the same way as a mirror reflects light.

### **Construction Materials**

Modern construction materials have relatively poor conductivity levels with the result that electromagnetic waves, even if attenuated, can still pass through.

Thus, radio traffic is possible within and through buildings.

Attenuation qualities of the construction materials vary greatly, so that there are different ranges in the corresponding directions, depending on the construction material that must be penetrated.

- Wood, dry and unprocessed: negligible attenuation
- Glass, plastics (non-conductive): negligible attenuation
- Wood, moist and processed, e.g., as particle board: medium range of attenuation
- Brick masonry: medium range of attenuation
- Reinforced concrete, glass with metal reinforcement/coating: greatest attenuation

This attenuation is mitigated by openings, especially by windows in buildings as long as they do not have wire-reinforced or metal-plated glass.

### **Scenarios**

The different radio wave propagation conditions give rise to various scenarios in which radio cells are formed:

- **In the Open with Visibility**  
In an open area with visibility, the electromagnetic waves are subject to the lowest amount of attenuation with the result that they produce the greatest radio wavelength.  
In principle, base stations in such a scenario can produce radio coverage ranges with a radius of up to 300 m. This, however, is usually not possible since trees, bushes and moving obstacles (such as people, animals and vehicles) in the direct propagation route can significantly reduce propagation.

---

**INFO:** A base station installed in an attic directly beside a dormer window (no wire-reinforced or metal-plated window pane) is the alternative to the outdoor housing for radio coverage of the outdoor area!).

When choosing this installation location, it is important to note that the base station is often exposed to extreme environmental temperatures (for example, by direct sunlight or cold).

---

- **Industrial Sites**  
The attenuation of electromagnetic waves in this scenario is primarily dependent on the design of the building.  
An industrial site may include a combination of buildings made of light-weight materials, brick buildings, buildings of reinforced concrete and buildings with metal facades.  
The distances between the buildings are seldom greater than 100 m. In this scenario, outdoor base stations are practical for covering the outdoor area.



- Buildings of brick or light construction materials  
Buildings of brick or light construction materials are usually penetrated by radio waves. However, behind the buildings, the strength of the reception field may be practically too low, resulting, quasi-optically, in a shadowed area.  
For example, in the case of a base station installed on the southern side of a brick building, the range limit would be reached on the northern side immediately or after just a few meters, owing to the insertion loss.  
Up to 100 m of the outdoor area can also be supplied through the windows. However, to do this, the base station must be set up on an upper floor (> 3rd floor, i.e., two levels above ground floor). Low obstacles close to the base station such as vehicles or a garage (for one or two cars), for example, will not cause significant interference.
- Reinforced concrete buildings and/or buildings with metal facades  
Reinforced concrete buildings and buildings with metal facades have proven to be severe limiting factors. Penetration into these buildings is only possible through windows (up to about 2 m into the building in the case of standard size windows). The windows cannot be made from wire-reinforced or metal-plated glass.  
Wave conduction is possible in alleys between buildings as well as along streets. This results in a larger radio area.
- Indoor Areas in Buildings in Brick and Light Construction Materials  
Within buildings made of brick and light-weight construction materials, the electromagnetic waves in the horizontal direction are hindered much less than in the vertical direction.
  - Horizontal attenuation  
In the case of walls of brick or light construction materials, the attenuation values are relatively small so that even dividing walls of up to 30 m can be penetrated.
  - Vertical attenuation  
This is dependent on the ceiling type. In this case, reinforced concrete ceilings, in particular, which result in higher attenuation compared to brick, play a decisive role in determining the range.  
The ceilings are dimensioned according to the purpose of a building (single-family home, condominium, office building, theatre etc.), and the resulting attenuation values may therefore vary accordingly.

<b>Object</b>	<b>Attenuation</b>	<b>Range loss</b>
Brick wall, 10 to 12 cm	2.5 dB	Approx. 43,5 %
Brick wall, 24 cm, with small windows	4 dB	Approx. 60 %
Brick wall, 63 to 70 cm	4.0 to 4.5 dB	Approx. 60 to 64 %
Drywall	1.3 to 2.3 dB	Approx. 26.5 to 41 %
Gaseous-concrete wall	6.6 dB	Approx. 78 %
Glass wall	2 dB	Approx. 37 %
Wire-reinforced glass wall	8 dB	Approx. 84 %
Reinforced concrete ceiling (residence)	6 to 9 dB	Approx. 75 to 87 %
Two reinforced concrete ceilings	26 dB	Approx. 99,5 %
Three reinforced concrete ceilings	46 dB	Approx. 100 %

When installing base stations, it must be taken into account that radio wave propagation within buildings is hindered much less in a horizontal direction than in a vertical direction.

- Interiors of reinforced concrete buildings
 

Indoor areas in reinforced concrete buildings can give rise to different scenarios, depending on the interior layout.

  - Factory halls and open-plan offices
 

These are either not partitioned (for example, manufacturing halls) or have mobile partitions reaching half way to the ceiling (open-plan offices). The propagation conditions are favorable, since intervisibility and line of sight are more frequent in such cases than in buildings with individual offices, for example.
  - Interiors of brick and light construction materials
 

The propagation conditions are similar to those in buildings with brick outer walls.

Due to the requirements in the industrial sector, the reinforced concrete floors in these buildings are often dimensioned in such a way that the insertion loss of the ceilings is much higher than for brick buildings.

The resulting unfavorable vertical radio wave propagation must be taken into consideration when installing the base station.
  - Interiors with concrete and steel dividing walls
 

These areas usually include the heavily steel-reinforced areas found in stairwells, bathroom units, supply shafts and elevator shafts.

The following table lists some attenuation values relevant for this scenario together with the corresponding details of the range loss.

Object	Attenuation	Range loss
Concrete wall, interior, 10 cm	6 dB	Approx. 75 %
Concrete wall, double, 2 x 20 cm	17 dB	Approx. 97,5 %
Concrete wall, 25 to 30 cm	9.4 to 16 dB	Approx. 88 to 97.5 %
Reinforced concrete ceiling	12 to 14 dB	Approx. 91 to 96 %
Two reinforced concrete ceilings	35 to 47 dB	100 %
Three reinforced concrete ceilings	42 to 53 dB	100 %
Steel dividing walls with wire-reinforced glass	6.5 to 10 dB	Approx. 75.5 to 90 %
Steel dividing walls, extending to ceiling, 3.5 m dist.	31 to 41 dB	100 %

The horizontal and vertical propagation conditions are approximately the same. In this type of building, transmission usually takes place along corridors if steel divider walls are installed.

As the relatively high attenuation values show, individual rooms are increasingly supplied via reflection if multiple metal walls are in the direct path.

Concrete walls cause similar conditions. Elevator shafts and stairwells must therefore often have their own base station if they are to be covered by the radio area.

### 5.3.3 Placement of Base Stations Indoors

The locations of base stations are of vital importance for the radio coverage within a building and for the performance of a cordless solution.

#### **Building of Brick or Light Construction Materials**

The following guidelines must be considered for the placement of base stations in buildings made of brick and light-weight construction materials:

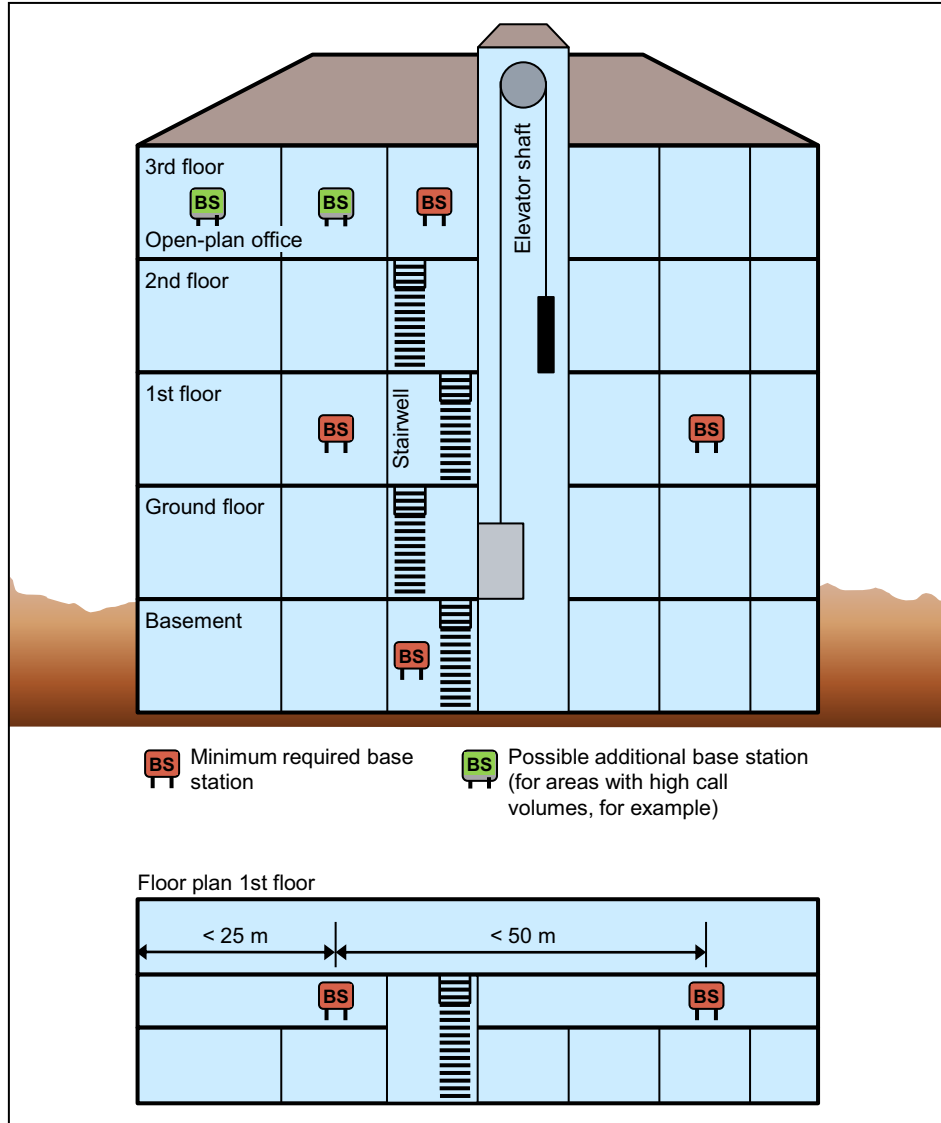
- Central placement in the building  
The general rules must be observed
- Horizontal direction  
A base station must be installed at least every 50 m.
- Vertical direction

Note that there should be no more than two reinforced concrete slabs in the direct radio wave propagation path between the base station and the range of

motion of the DECT telephones. Otherwise, adequate coverage cannot be guaranteed.

If additional base stations are required due to areas with high call volumes, these can be placed as shown in the following figure.

**Figure:** Example for the placement of base stations in buildings made of brick and light-weight construction materials:



**Reinforced concrete buildings with interior of brick and light construction materials**

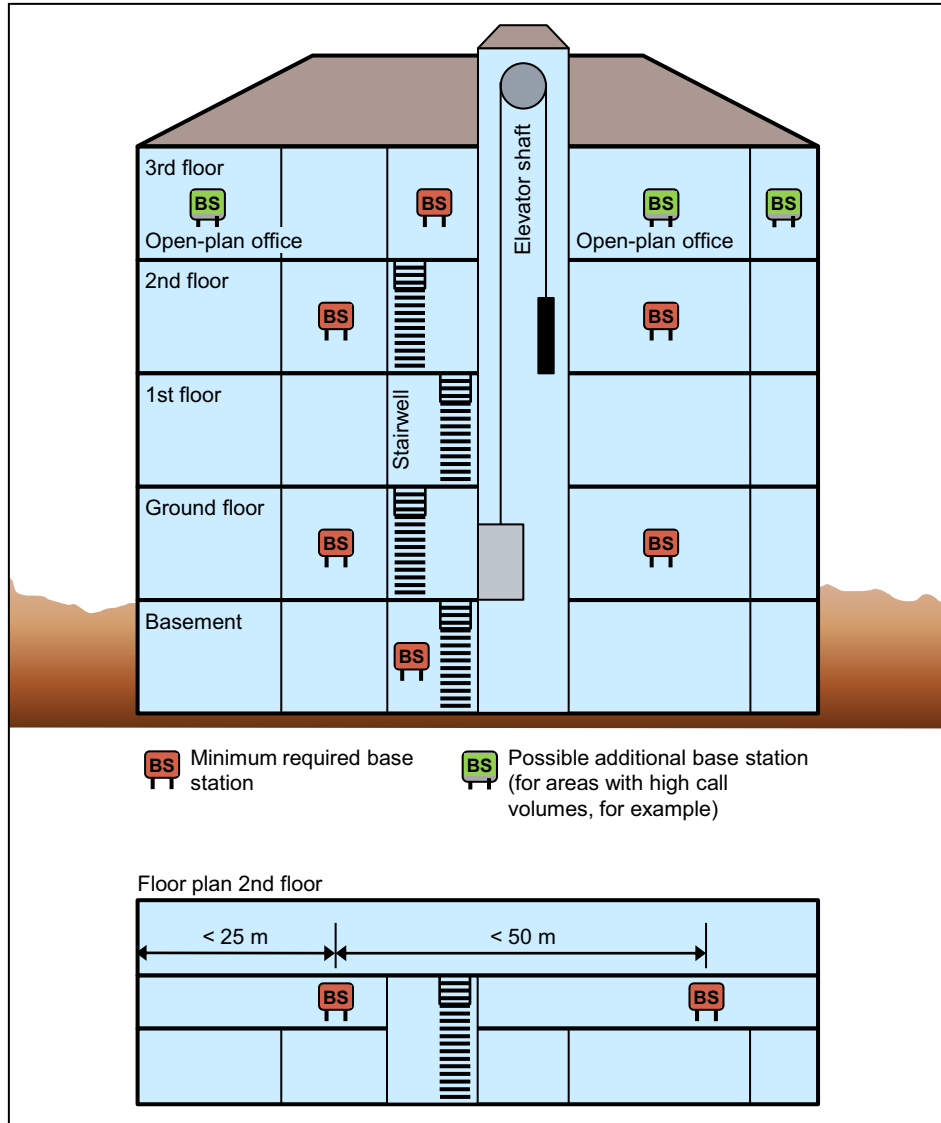
The following guidelines must be considered for the placement of base stations in reinforced concrete buildings with an interior made of brick and light-weight construction materials:

- Central placement in the building  
 The general rules must be observed

- Horizontal direction  
A base station must be installed at least every 50 m.
- Vertical direction  
Note that there should be no more than one reinforced concrete slab in the direct radio wave propagation path between the base station and the range of motion of the DECT telephones. Otherwise, adequate coverage cannot be guaranteed.  
Stairwells, elevator shafts and supply ducts in these buildings usually have strongly-reinforced concrete walls and stairs. Areas such as these, with poor propagation conditions, often require additional base stations.

If additional base stations are required due to areas with high call volumes, these can be placed as shown in the following figure.

**Figure:** Example for the placement of base stations in steel concrete buildings with an interior made of brick and light-weight construction materials:



**Reinforced concrete buildings with concrete and steel dividing walls**

The following guidelines must be considered for the placement of base stations in steel concrete buildings concrete and steel dividing walls:

- Central placement in the building  
 The general rules must be observed
- Horizontal direction  
 Because of the relatively high attenuation of concrete and steel dividing walls, a base station must be installed in these buildings at least every 25 m.
- Vertical direction  
 Note that there should be no more than one reinforced concrete slab in the direct radio wave propagation path between the base station and the range of

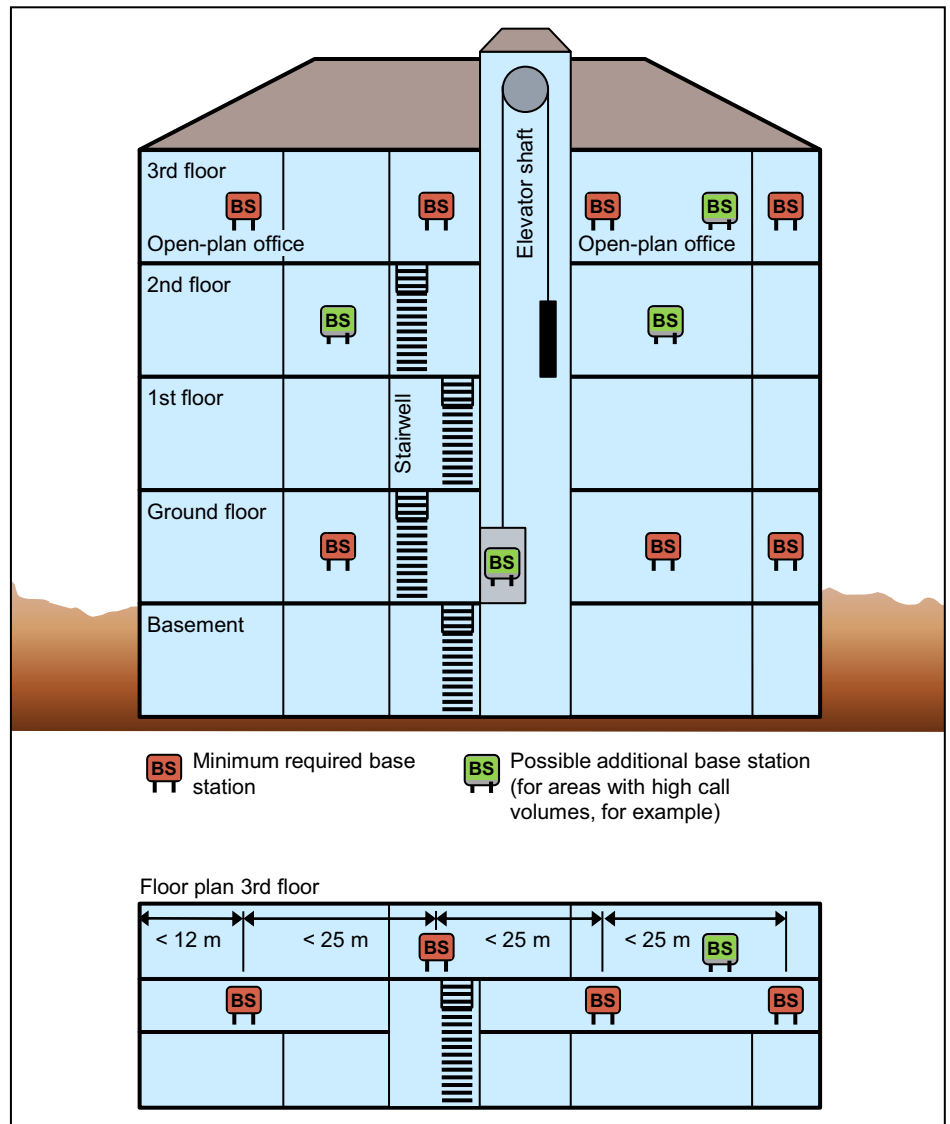
motion of the DECT telephones. Otherwise, adequate coverage cannot be guaranteed.

Stairwells, elevator shafts and supply ducts in these buildings usually have strongly-reinforced concrete walls and stairs. Areas such as these, with poor propagation conditions, often require additional base stations.

For example, in the case of elevators, a base station can be installed in the elevator cabin itself.

If additional base stations are required due to areas with high call volumes, these can be placed as shown in the following figure.

**Figure:** Example for the placement of base stations in steel concrete buildings with concrete and steel walls



### Factory Halls and Open-Plan Offices

For a hall that is 100 m long, one centrally located base station, suspended freely from the ceiling (plastic mast or chain), may be sufficient.

---

**NOTICE:** The base station should not be installed on a reinforced concrete pillar because the pillar creates a partial shadow.

In this case, two base stations at a distance of 50 to 75 m must be installed.

---

In the case of outer walls or interior siding and/or hall ceilings made of metal or metal-clad materials, it may be necessary to increase the number of base stations. The base stations should then be placed in a way that virtually excludes radio interference through reflections.

### 5.3.4 Placement of Base Stations Outdoors

The locations of base stations are crucial for the radio coverage of outdoor areas such as the premises of a factory, for example. The weatherproof outdoor housing protects the base station mounted therein and allows the use of the base station in outdoor areas.

The installation of a base station in the outdoor housing can be done on a building wall, on the roof of a building (preferably in brick or light construction materials) or on a plastic, wooden or concrete pole (not metal). The pole used must be stable and wind-resistant.

Choose the installation site to allow for maximum visibility from the base station to the service area.

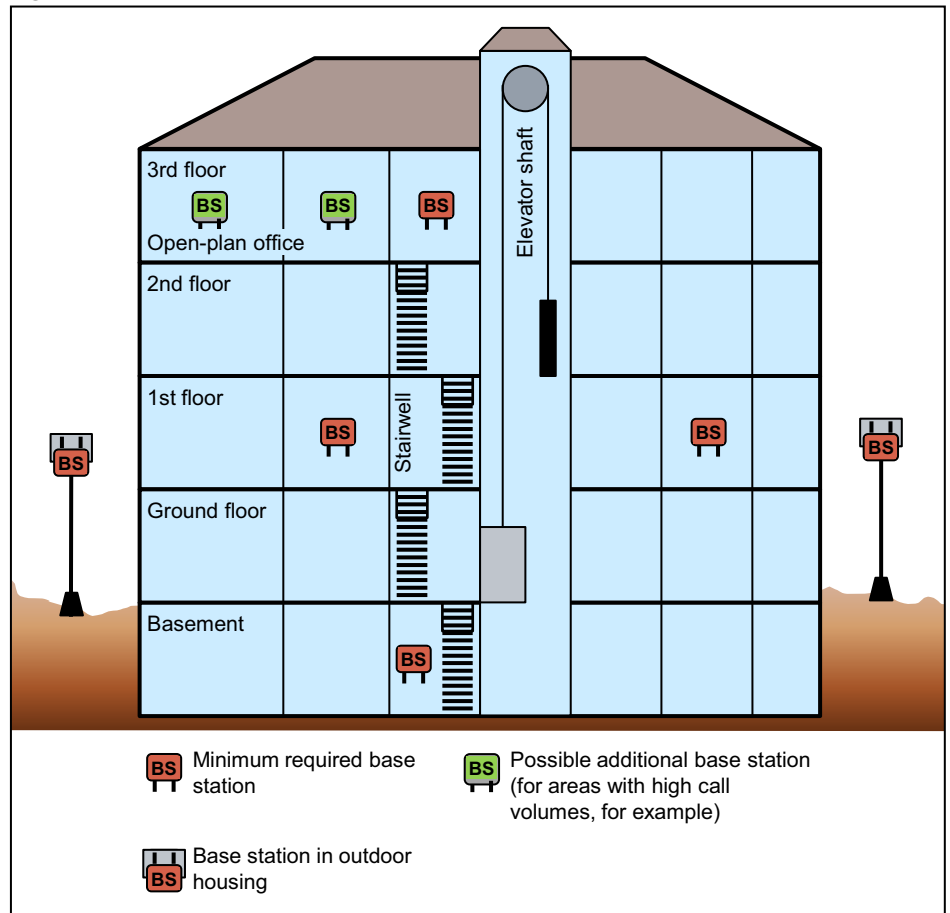
Reinforced concrete buildings and structures with metal facades have proven to be a barrier. Areas behind these buildings are quasi-optically blocked and must be considered not covered by the radio waves.

Brick buildings are usually penetrated so that significant parts of them are reached by the radio waves. The coverage, however, often stops less than 10 meters beyond these buildings.

Streets act as waveguides so that greater ranges are possible along them.



**Figure:** Example for the placement of base stations outdoors



### Example of the Planning for Radio Coverage of an Outdoor Area

A site plan on a scale of 1:300 or 1:1000, for example, can be very useful for the placement of base stations. Additional information about the types of buildings and their heights is also helpful.

The client's/customer's preferred radio coverage area should be drawn on the site plan and approved by the client/customer.

The following figure shows the example of a factory premises with the buildings A to G as well as their respective type of construction and height.

Using the plan, it is relatively simple to find the point which offers the best possible view of the grounds without any obstructions.

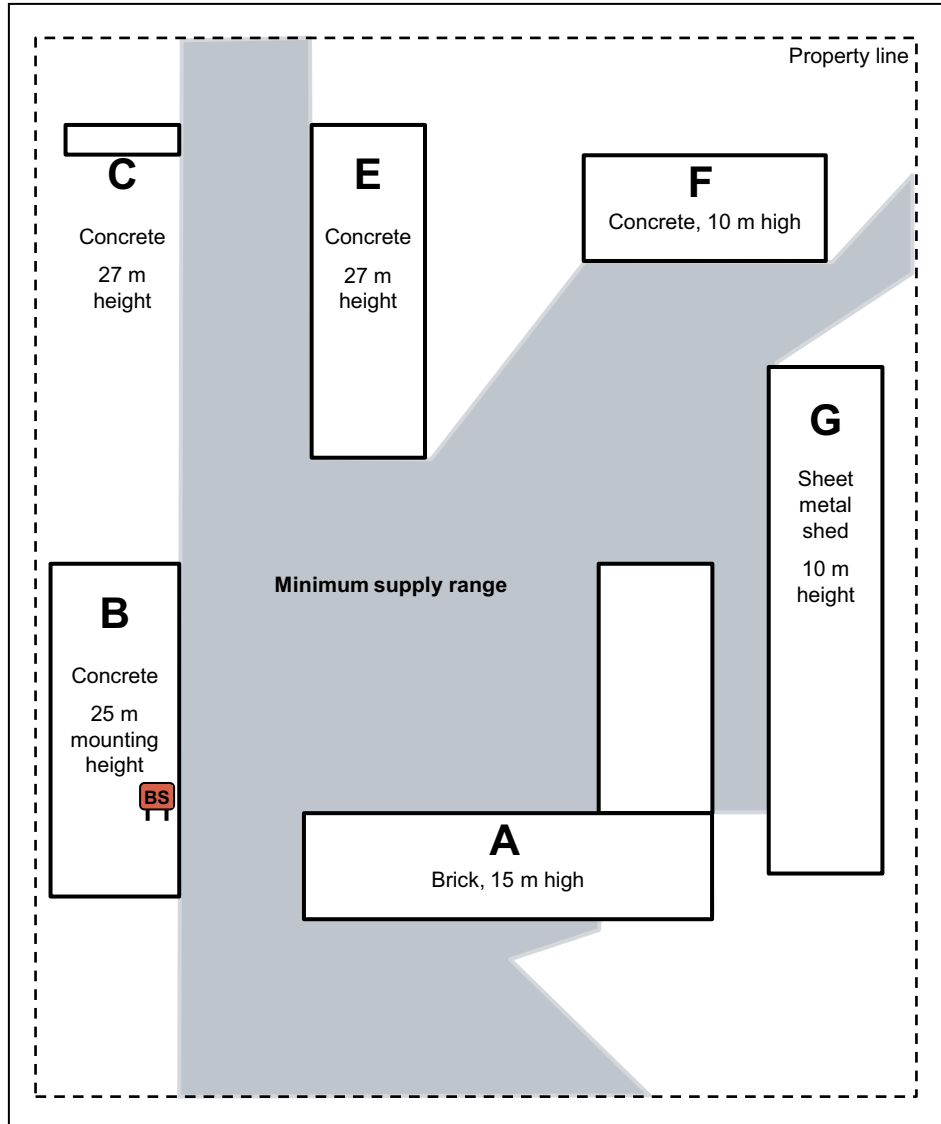
Placement around the buildings C, E, F, and G is not feasible, since the view from these buildings extends only to a few neighboring buildings.

The view from buildings A and B is better.

In the example, the decision was made to place the base station at building B rather than A. Note that the areas between buildings C and E as well as F, G, and A are covered. The radio waves can pass through brick building A, so that an area

of about 10 meters beyond will still be covered. In practice, coverage can also be assumed for other outdoor areas as waves pass through the windows.

**Figure:** Example for the placement of a base station to ensure radio coverage for the premises of a factory



## 5.4 Installing and Connecting Base Stations

### 5.4.1 Prerequisites for Installation

To install the base stations, you will need some specific tools and resources. Certain requirements must be observed when selecting the installation site.

## Tools and Resources

The following tools and resources are required:

- For the indoor installation of a base station:
  - Drill and masonry bit with a diameter of 5 mm for wall-mounting of the base station
- For the outdoor installation of a base station with the outdoor housing:
  - Phillips screwdriver size 3, to attach for the mounting plate to the outdoor housing
  - Phillips screwdriver size 2, to attach the mast blocks to the outdoor housing
  - Triangular screwdriver size M6, to open/close the cover of the outdoor housing
  - Drill and masonry bit with a diameter of 8 mm for wall-mounting of the outdoor housing

## Prerequisites for Selecting the Installation Site

Make sure that the installation site meets the following requirements:



### CAUTION

#### Security zones

Base stations must not be installed in the security zones declared by the client/customer. Typical examples include intensive care units in hospitals and areas behind fire-proof doors.

- 
- Indoor base stations must be freely accessible and mounted as close to the ceiling as possible (but with > 0.5 m clearance from the ceiling). They should be mounted near the center of a building, for example, in corridors or on walls of directly adjacent rooms (in the case of buildings of light construction materials).
  - Outdoors, a base station can only be operated in the outdoor housing.
  - Do not expose the base stations to direct sources of heat (for example, direct sunlight, radiators, etc).
  - The following ambient temperature ranges must not be exceeded in either direction:
    - - 5 to + 50 °C when operating a base station indoors
    - - 20 to + 50 ° C when operating a base station outdoors (BS in outdoor housing)
  - Base stations must not be installed in damp places (such as bathrooms and laundry rooms, or example). The maximum humidity for the operation of a base station indoors and outdoors (BS in outdoor housing) is 85%.
  - To avoid limitations on the radio coverage, base stations must not be installed in the following places:
    - In wall recesses or on thick or concrete and metal walls, if the radio supply area is behind them.

- On steel or concrete pillars, since any radio areas behind them may not be covered.
- In lowered ceilings made of metal (i.e., conductive materials such as carbon fibre, for example)
- On metal panels if a safety clearance of more than 10 cm is not possible.
- On high metal shelves if a safety clearance of more than 3 m is not possible.
- To avoid interference from unwanted electrical or electromagnetic effects, base stations must not be installed in the following places:
  - In the vicinity of other electronic equipment such as wireline telephones, Hi-Fi, Office or microwave equipment, etc., if a safety clearance of more than 1 m is not possible.
  - Next to neon or fluorescent tubes, fire detection devices, switchboards, transformers and motor housings, if a safety clearance of more than 1 m is not possible.
  - Next to the antennas of other communication systems, if a safety clearance of more than 3 m is not possible.The respective safety distances isolate the installation from other equipment, thus improving the electromagnetic compatibility (EMC).
- Base station connection cables should not, where possible, be laid parallel to low voltage power cables (for example, 115 Vac, 230 Vac) or cable bundles.

## 5.4.2 Installation Indoors

The base stations must be freely accessible and mounted as close to the ceiling as possible (but with > 0.5 m clearance from the ceiling). They should be mounted near the center of a building, for example, in corridors or on walls of directly adjacent rooms (in the case of buildings of light construction materials).

### 5.4.2.1 How to Mount the Base Station Indoors

#### *Prerequisites*

- The prerequisites for selecting the installation site were taken into account (see [Prerequisites for Installation](#)).
- Two anchors with a diameter of 5 mm and two screws with a diameter of 3.5 mm are available to wall-mount the base station.

---

**INFO:** Different mounting material may be needed, depending on the composition of the mounting wall (for example, wood screws for wooden walls).

---

### Step by Step

- 1) Drill two vertically overlapping holes at a distance of 110 mm with a diameter of 5 mm into the mounting wall.
- 2) Insert the wall anchors into the drill holes and screw in the screws, leaving approx. 4 mm projecting.
- 3) Hang the base station on the screws at the mounting holes and align it.

---

**INFO:** To achieve the best possible performance, base stations of the types BS4 and BS5 should be mounted with the antennas pointing downwards. Base stations of types BS3/1, BS3/3 and BS3/S should be mounted with the antennas pointing upwards.

---

## 5.4.3 Outdoor Installation

Outdoors, a base station can only be operated in the outdoor housing. Choose the installation site of the outdoor cover to allow for maximum visibility from the base station to the service area.

---

**INFO:** Information on the installation procedure can be found in the installation instructions/description included in the delivery package for the outdoor housing.

---

## 5.4.4 Connection of Base Stations

The connection of the BS5 base station at the U<sub>P0/E</sub> interface of a mainboard (direct connection) or a Cordless board (board connection) occurs via the connector strip X1.

### 5.4.4.1 How to Connect the Base Station

#### Prerequisites



---

#### WARNING

##### Risk of electric shock through contact with live wires

Use separate ground wires to provide protective grounding for the system boxes of your communication system as well as all main distribution frames and patch panels before connecting the base stations.

---



---

## CAUTION

### Fire hazard

To reduce the risk of fire, you may only use communication cables with a conductor diameter of at least 0.4mm (AWG 26) or larger.

---

---

#### **NOTICE:** Fire hazard due to surge voltage

In the case of line lengths exceeding 500 m and where the lines exit the building, the SLC16N and SLCN boards must be protected by external lightning protection.

Lightning protection of this kind is known as additional primary protection. The additional primary protection is guaranteed by installing ÜSAGs (surge arresters, gas filled) in the main distribution frame, the patch panel or at the entry point of the pipe in the building. A gas-filled surge arrester with 230 V nominal voltage is switched to ground from each wire that is to be protected.

---

- Direct connection of the base station: at least one free  $U_{P0/E}$  interface is available on the mainboard of the communication system (OpenScape Business X3 or OpenScape business X5).
- Board connection of the base station: at least one free  $U_{P0/E}$  interface is available on the SLC16N (OpenScape Business X5W) or SLCN (OpenScape Business X8) board.

### Step by Step

- › Connect the desired  $U_{P0/E}$  ports with the base station.

Select one of the following options to do this:

- If a direct connection to the base station is required, connect the desired  $U_{P0/E}$  interface of the mainboard (OpenScape Business X3 or OpenScape Business X5) to the base station.
- If a board connection of the base station is required, connect the desired  $U_{P0/E}$  interface(s) of the SLC16N (OpenScape Business X5W) or SLCN (OpenScape Business X8) board to the base station via one pair of wires each of the connection cable.

---

**NOTICE:** The connection of a base station must be made via the same cordless board. The connection to a different cordless board is prohibited.

---

For more detailed information on cable and pin assignments, see [OCCM](#), [OCCMR](#) for direct connection of the base station

Not for U.S.: SLC16N, Not for U.S.: SLCN for the board connection of the base station

### Next steps

After connecting all the base stations, you can begin with the initial startup of the integrated cordless solution.

Refer to the topic *Mobility* in the *OpenScape Business Administrator Documentation* for detailed information.

## 5.5 Testing a Cordless Solution

To ensure trouble-free operation of a cordless solution, a number of different tests must be conducted after the initial startup. The test results must be documented in the building/site plan.

### 5.5.1 Checking the Base Stations and the Radio Coverage

After the initial startup of a cordless solution, a test of the base stations and the radio coverage (area coverage) must be conducted.

---

**NOTICE:** The following information refers to measurements performed with DECT phones. The resulting measurement values are not very precise and thus represent only a rough estimate. In addition, different values may be recorded on each DECT phone even though the ambient conditions are identical.

If greater accuracy is required, the measurements should be performed with a special service tool for cordless systems (such as the HCS Locator Pro, for example).

---

#### Base Station Test

The purpose of this test is to check the functions of all base stations.

- Test the radio link (synchronicity) between the DECT phone and the base station
- Measure the following values:
  - RSSI (Received Signal Strength Indication)  
Field strength of the radio signals received from a base station, normalized to a maximum of 100.  
If the RSSI value is < 50, the radio connection to the base station is no longer guaranteed. An acceptable RSSI value is > 50 (> - 60 dBm).

- FRAQ (Frame Quality)  
Transmission quality in %  
Values of 95 % to 100 % are satisfactory (for short periods, values of 90 % to 94 % are non-critical). Sustained values below 95% result in transmission errors.

### **Test the radio coverage (are coverage)**

The purpose of this test is to check whether the necessary field strength and the transmission quality is attained throughout the entire radio network.

Using a DECT phone (with the measuring mode enabled), move around the radio coverage area and check whether an RSSI value > 50 (> -60 dBm) and a FRAQ value > 95% are achieved throughout the area. Areas in building corners or behind metal structures, in particular, should be checked carefully (by verifying the RSSI values several times).

Activating the range warning feature is useful in this context. Exceeding the range limit (border zone of the radio range) is then signaled by a warning tone.

In these border zones of the radio range, the radio connection to the base station may be lost.

### **Presentation of the Measurement Results**

The following value is an example of the display of a measurement result on a DECT phone of type OpenStage SL4 Professional (Gigaset SL4 Professional):

087-7-02-20-100

- 087 = Field strength (RSSI) of the radio signals received from the base station (maximum value = 100)
- 7 = Frequency (value range 0 to 9)
- 02 = Time slot of the receiving channel on which the measurement was performed (value range 0 to 11).
- 20 = Identification of the base station via the Radio Fixed Part Identity RFPI as a hexadecimal number (20 corresponds to decimal 32)
- 100 = Transmission quality (FRAQ) in %

## **5.5.1.1 Testing Base Stations**

---

**INFO:** The following information refers to the operation of a DECT phone of the type OpenStage SL4 Professional (Gigaset SL4 Professional).

The default language for measuring mode is English.

---

### **Step by Step**

- 1) Move with the DECT phone close to a base station to be tested.
- 2) Holding the DECT phone directly below, beside or above the base station to be tested, turn it off and on again.



- If a radio link (synchronicity) with the base station exists, this will be indicated in the display as *Station 1*, for example.  
Continue with step 3.
  - If there is no radio link (synchronicity) with the base station, this will be indicated by a flashing display (for example, *Station 1* will be shown flashing).  
Repeat step 2 with another DECT telephone. If no radio link can be established with this DECT phone as well, replace the base station.
- 3) Turn off the DECT phone.
  - 4) Press the keys **1**, **4** and **7** simultaneously together with **Hang up** key in order to activate the service mode.  
*Service* appears on the display.
  - 5) Enter the code **76200** to bring up the service menu.
  - 6) In the service menu, navigate to the item **Measuring mode** and confirm the selection with the **OK** key.  
This enables the measuring mode.
  - 7) In the service menu, navigate to the item **Measuring time** and confirm the selection with the **OK** key.
  - 8) Set the desired measuring time using the control keys (< = to reduce the measuring time, and > = to increase the measuring time).  
The displayed value range for the measuring time is between 06 and 16. This corresponds to a measuring cycle between 1 and 2.5 seconds.  
The recommended value of 16, which corresponds to a measuring cycle of 2.5 seconds.
  - 9) Confirm the set values by pressing the **Save** key.
  - 10) Turn off the DECT phone.
  - 11) Turn on the DECT phone again.  
After switching on the DECT phone, the measurement values are shown on the display and updated on the basis of the set measuring cycle.  
For example: 087-7-02-20-100 (see [Checking the Base Stations and the Radio Coverage](#))
    - If the required measurement values (RSSI value > 50 (> - 60 dBm), FRAQ > 95%) are achieved, continue with step 12.
    - If the required measurement values (RSSI value > 50 (> - 60 dBm), FRAQ > 95%) are not achieved, repeat steps 3 through 11 with another DECT phone.  
If this DECT phone does not reach the required measurement values either, replace the base station.
  - 12) Repeat the testing for all other base stations.

## 5.5.1.2 Check the Radio Coverage

---

**INFO:** The following information refers to the operation of a DECT phone of the type OpenStage SL4 Professional (Gigaset SL4 Professional).

The default language for the measuring mode is English.

---

### Step by Step

- 1) Turn off the DECT phone.
- 2) Press the keys **1**, **4** and **7** simultaneously together with **Hang up** key in order to activate the service mode.

*Service* appears on the display.

- 3) Enter the code **76200** to bring up the service menu.
- 4) In the service menu, navigate to the item **Measuring mode** and confirm the selection with the **OK** key.

This enables the measuring mode.

- 5) In the service menu, navigate to the item **Measuring time** and confirm the selection with the **OK** key.
- 6) Set the desired measuring time using the control keys (< = to reduce the measuring time, and > = to increase the measuring time).

The displayed value range for the measuring time is between 06 and 16. This corresponds to a measuring cycle between 1 and 2.5 seconds.

The recommended value of 16, which corresponds to a measuring cycle of 2.5 seconds.

- 7) Confirm the set values by pressing the **Save** key.
- 8) Turn off the DECT phone.
- 9) Turn on the DECT phone again.

After switching on the DECT phone, the measurement values are shown on the display and updated on the basis of the set measuring cycle.

Example: 087-7-02-20-100

- 10) With a DECT phone, move around the area in question and determine whether an RSSI value > 50 (> -60 dBm) and a FRAQ value > 95 % are reached throughout the area.

Pay particular attention to areas in building corners and behind metal structures (by measuring the RSSI values several times).

---

**INFO:** Enable the "Range warning" feature (Tones menu).  
Exceeding the range limit (border zone of the radio range) is then signaled by a warning tone.

In these radio area border zones, the radio connection to the base station may be lost.

---

11) Draw the coverage area with an RSSI value > 50 in the building/site plan.

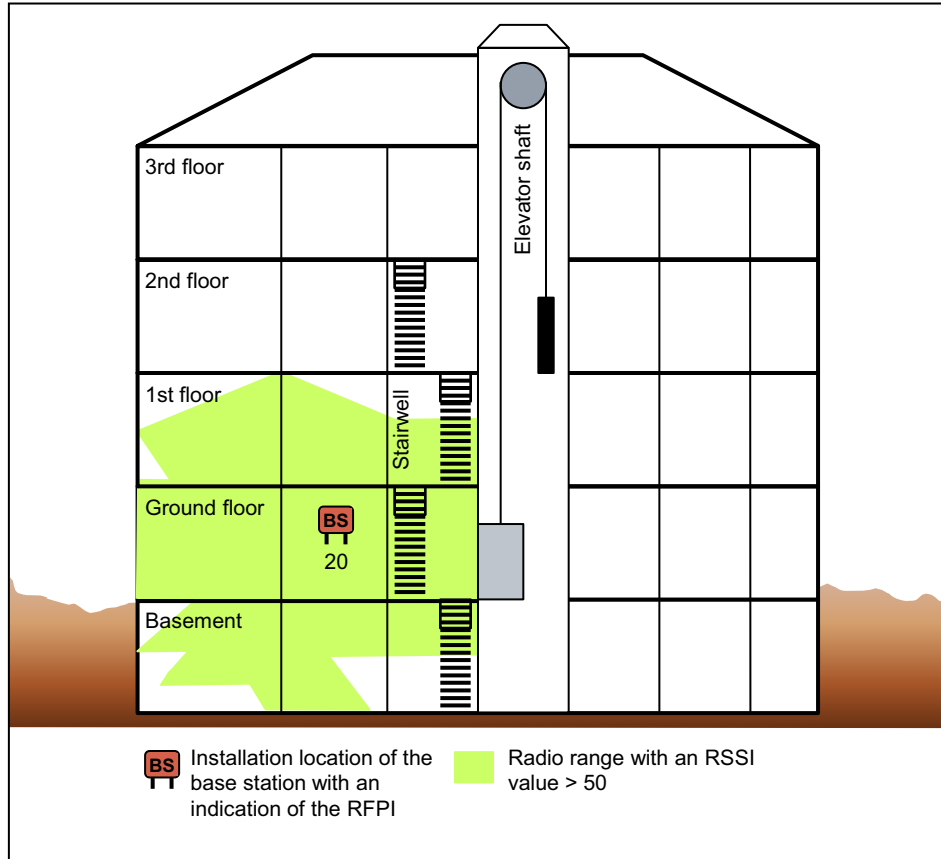
## 5.5.2 Documentation of the Test Results

The test results of the radio coverage (area coverage) must be entered or marked in the building/site plan.

The following data should be documented:

- Installation locations of the base stations and their Radio Fixed Part Identity RFPI
- Radio range with an RSSI value > 50

Figure: Example for the Documentation of Test Results in a Building Plan



## 5.6 Troubleshooting

Here you will learn how to troubleshoot and correct potential disruptions and errors.

### Synchronization symbol on the display of DECT phones

- No synchronization to base station: Flashing display of Station XY
  - DECT phone not logged on?  
Remedy: Log in the DECT phone.
  - If the DECT phone is logged into multiple systems, is it switched to the correct system? Is automatic system selection activated?  
Remedy: Check the registration of the DECT phone. If necessary, log in the DECT phone again.
  - Base station defective?  
Remedy: [Testing Base Stations](#).
- Synchronization to the base station: Steady display of Station XY, but no action is possible.

- An error tone can be heard when the line key is pressed: Temporary overload status (all the base station speech paths are busy).  
Remedy: Wait, and try again.
- DECT phone has not completed the location request (contact of the DECT phone to the communication system) successfully.  
Remedy: Repeat location request by switching off the DECT phone and then switching it on again.
- DECT phone is no longer registered.  
Remedy: Log in the DECT phone again.

### DECT telephone

- Problems when logging in:
  - Are the "home cordless board" and at least one base station (within range of the DECT phone) as well as the Cordless board to which this base station is connected operational (is the green LED lit on the Cordless board?)
  - If the DECT phone is to be registered via a "current-location cordless board", the extension connections must be operational.  
A connection to the extension connection port must be tested by using a corded phone. If the call succeeds, the connection is OK. Otherwise, an error has occurred, and the configuration of the extension connection must be checked.
  - Is a sufficiently accurate clock pulse supply ensured by the communication system?  
If the station display on a registered DECT phone is not permanently active, this could indicate a bad clock pulse supply. For example, if `Base Search` occasionally appears in the idle state.
- No visual user prompts:
  - When logging in the DECT phone, was the line key pressed before the "Silent Call" arrived?  
Remedy: Log in the DECT phone again and wait for Silent Call. If the error persists, the phone involved is an unauthorized DECT phone.

## 6 Appendix

The appendix contains reference information such as hardware capacity limits, the interface ranges for subscriber lines, the maximum cable lengths for trunk connections and direct CorNet NQ/QSIG wiring and the country-specific ring frequencies for analog subscriber line modules. In addition, it also includes information on the power requirements of the boards and connectable telephones, key modules, adapters and base stations.

### 6.1 Hardware Expansion

The hardware expansion details refer to the OpenScape Business X3R/X3W, OpenScape Business X5R/X5W and OpenScape Business X8 communication systems.

#### Hardware Expansion for OpenScape Business

System Box	Maximum configuration
OpenScape Business X8 system box	2

The following table lists the maximum number of time-division multiplex channels that the different boards require. A distinction is made here between:

- **Static assignment**  
Time-division multiplex channels are assigned statically for trunk and tie-traffic boards. This ensures that all calls can be processed.
- **Dynamic assignment**  
Time-division multiplex channels are subject to dynamic assignment in subscriber line modules. The channels are seized with every call and released at the end of each call. The current number of time-division multiplex channels required is determined by the number of active stations.
- **Static/dynamic assignment.** For boards with  $S_0$  interfaces, the way in which the time-division multiplex channels are assigned depends on the actual use of the individual  $S_0$  interfaces. The channels are assigned statically if the  $S_0$  interface is used for the ISDN trunk connection (ISDN trunk). The channels are assigned dynamically if the  $S_0$  interface is used for the ISDN station connection.

OpenScape Business X8 provides PCM highway trunk groups with 2 x 4 PCM highways for each peripheral board slot. There are 32 time-division multiplex channels available for each PCM highway. If all of these channels are busy, no further call requests can be accepted. To guarantee that the communication system operates without blocking, make sure when performing configuration that the boards on a PCM segment do not require more than the number of time-division multiplex channels available. For detailed information on the distribution of the PCM highways and the boards installed in OpenScape Business X8, see *OpenScape Business, Installation Guide, Installing the Hardware for OpenScape Business X8*.

Regardless of which boards are installed in OpenScape Business X3R/X3W, OpenScape Business X5R/X5W, blocking-free operation is ensured at all times.

Peripheral board	Part Number	Maximum number of time-division multiplex channels required	Time-division multiplex channel assignment	Use in OpenScape Business				
				X3R	X3W	X5R	X5W	X8
4SLA <sup>1</sup>	S30810-Q2925-X100 S30810-Q2923-X200	4	Dynamic		X		X	
8SLA <sup>1</sup>	S30810-Q2925-X S30810-Q2923-X100	8	Dynamic		X		X	
8SLAR <sup>1</sup>	S30810-K2925-Z	8	Dynamic	X		X		
16SLA <sup>1</sup>	S30810-Q2923-X	16	Dynamic		X		X	
DIU2U <sup>1</sup>	S30810-Q2216-X (For U.S. only)	48	Static					X
DIUN2 <sup>1</sup>	S30810-Q2196-X	60	Static					X
DIUT2	S30810-Q2226-X100	60	Static					X
IVMN8 <sup>1</sup>	S30122-H7688-X200	8	Dynamic					X
IVMNL	S30122-H7688-X	24	Dynamic					X
IVMP4	S30122-Q7721-X	4	Dynamic		X		X	
IVMP4R	S30122-K7721-F	4	Dynamic	X		X		
IVMS8N	S30122-Q7379-X200	8	Dynamic		X		X	
IVMS8NR	S30122-K7379-Z200	8	Dynamic	X		X		
SLA16N <sup>1</sup>	S30810-Q2929-X100	16	Dynamic				X	
SLA24N <sup>1</sup>	S30810-Q2929-X	24	Dynamic				X	
SLAD4	S30810-Q2956-X100	4	Dynamic		X		X	
SLAD8	S30810-Q2956-X200	8	Dynamic		X		X	
SLAD8R	S30810-K2956-X300	8	Dynamic	X		X		
SLAD16	S30810-Q2957-X	16	Dynamic		X		X	

**Appendix**  
Hardware Expansion

Peripheral board	Part Number	Maximum number of time-division multiplex channels required	Time-division multiplex channel assignment	Use in OpenScape Business				
				X3R	X3W	X5R	X5W	X8
SLC16N	S30810-Q2193-X100	64 <sup>2</sup>	Dynamic				X	
SLCN	S30810-Q2193-X300	128 <sup>2</sup>	Dynamic					X
SLMA2 <sup>1</sup>	S30810-Q2246-X	24	Dynamic					X
SLMA8 <sup>1</sup>	S30810-Q2191-C100	8	Dynamic					X
SLMA24 <sup>1</sup>	S30810-Q2191-C300	24	Dynamic					X
SLMAE8 <sup>1</sup>	S30810-Q2225-X100	8	Dynamic					X
SLMAE24 <sup>1</sup>	S30810-Q2225-X200	24	Dynamic					X
SLMAV8N	S30810-Q2227-X300	8	Dynamic					X
SLMAV24N	S30810-Q2227-X400	24	Dynamic					X
SLMO8N	S30810-Q2168-X300	16 <sup>3</sup>	Dynamic					X
SLMO24N	S30810-Q2168-X400	48 <sup>3</sup>	Dynamic					X
SLMU	S30810-Q2344-X100	48 <sup>3</sup>	Dynamic					X
SLMUC (SLMU + CMAe)	S30810-Q2344-X100 + S30807-Q6957-X	128 <sup>3</sup>	Dynamic					X
SLMO8 <sup>1</sup>	S30810-Q2901-X100	16 <sup>3</sup>	Dynamic				X	
SLMO24 <sup>1</sup>	S30810-Q2901-X	48 <sup>3</sup>	Dynamic				X	
SLU8N	S30817-Q922-A401	16	Dynamic		X		X	
SLU8NR	S30817-K922-Z401	16	Dynamic	X		X		
STLS2 <sup>1</sup>	S30817-Q924-B313	4	dynamic/static		X		X	
STLS4 <sup>1</sup>	S30817-Q924-A313	8	dynamic/static		X		X	



Peripheral board	Part Number	Maximum number of time-division multiplex channels required	Time-division multiplex channel assignment	Use in OpenScape Business				
				X3R	X3W	X5R	X5W	X8
STLS4R <sup>1</sup>	S30817-Q924-Z313	8	dynamic/static	X		X		
STLSX2	S30810-H2944-X100	4	dynamic/static		X		X	
STLSX4	S30810-H2944-X	8	dynamic/static		X		X	
STLSX4R	S30810-K2944-Z	8	dynamic/static	X		X		
STMD3	S30810-Q2217-X10	16	dynamic/static					X
TCAS-2	S30810-Q2945-X (for selected countries only)	60	Static				X	
TCASR-2	S30810-K2945-X (for selected countries only)	60	Static			X		
TLANI2	S30810-Q2953-X100  S30810-K2953-X182 (For Brazil only)	2	Static		X		X	
TLANI4	S30810-Q2953-X  S30810-K2953-X82 (For Brazil only)	4	Static		X		X	
TLANI4R	S30810-K2953-X200  S30810-K2953-X282 (For Brazil only)	4	Static	X		X		
TLANI8	S30810-Q2954-X100  S30810-Q2954-X101 (For international markets only)  S30810-K2954-X182 (For Brazil only)	8	Static		X		X	

Peripheral board	Part Number	Maximum number of time-division multiplex channels required	Time-division multiplex channel assignment	Use in OpenScope Business				
				X3R	X3W	X5R	X5W	X8
TM2LP <sup>1</sup>	S30810-Q2159-Xxxx	8	Static					X
TMANI	S30810-Q2327-X S30810-Q2327-X1 (for international markets only) S30810-K2327-X82 (For Brazil only)	8	Static					X
TMC16 <sup>1</sup>	S30810-Q2485-X	16	Static					X
TMCAS <sup>1</sup>	S30810-Q2938-X	30	Static					X
TMCAS2	S30810-Q2946-X (for selected countries only)	60	Static					X
TMDID <sup>4</sup>	S30810-Q2197-T (for selected countries only)	8	Static					X
TMEW2	S30810-Q2292-X100	4	Static					X
TS2	S30810-Q2913-X100	30	Static				X	
TS2R	S30810-K2913-Z100	30	Static			X		
TST1	S30810-Q2919-X	24	Static				X	
TST1R	S30810-K2919-Z	24	Static			X		

- <sup>1</sup> This board is being discontinued and can no longer be ordered. However, they can still be used in the communication systems of the OpenScope Business communication platform.
- <sup>2</sup> A time-division multiplex channel is required if a call is conducted via the "home cordless board" of a mobile telephone. If a call is conducted via a "current-location Cordless board", additional time-division multiplex channels are necessary.
- <sup>3</sup> The maximum possible number of masters and slaves is taken into account.
- <sup>4</sup> The TMDID board only uses the first half of a PCM segment, which means that up to 64 channels are available per PCM segment for TMDID static time-division multiplex channels. To guarantee that the communication system operates without blocking when using the TMDID, the boards on a PCM segment must not occupy more than 64 static time-division multiplex channels. Examples for a PCM segment: 2 x TMDID + 1 x DIU2U = 64 static time-division multiplex channels = approved equipment. 1 x TMDID + 1 x TMANI + 1 x DIUT2 = 76 static time-division multiplex channels = unapproved equipment. 1 x TMDID + 2 x SLMO2 = 8 static and 96 dynamic time-division multiplex channels = approved equipment.

## 6.2 Interface Ranges for Subscriber Lines

**Table:** The following table lists the maximum possible interface ranges for subscriber lines when using cables of type J-Y (ST) 2x2x0.6 (0.6 mm conductor diameter). Interface Ranges for Subscriber Lines (for J-Y (ST) 2x2x0.6, (0.6 mm conductor diameter))

Interface	Range	Loop resistance
S <sub>0</sub> : point-to-point connection	< 600 m	156 ohms
S <sub>0</sub> : extended bus connection	< 400 m	104 ohms
S <sub>0</sub> : bus connection	< 60 m, for the STMD3 board (S30810-Q2217-X10)	21 ohms
	< 120 m, for all other S <sub>0</sub> boards	21 ohms
S <sub>0</sub> : line jack unit for the phone	< 10 m	–
a/b	< 2000 m	520 ohms
U <sub>P0/E</sub> : master	< 1000 m	230 ohms
U <sub>P0/E</sub> : master-slave configuration	< 100 m	23 ohms

## 6.3 Cable Lengths for Trunk Connections and CorNet NQ/QSIG Direct Networking

The table below provides the maximum cable lengths for trunk connections and direct CorNet NQ/QSIG wiring. The values apply to ideal conditions, which means there can be no joints, etc. The real conditions must be measured on-site.

**Table:** Cable Lengths for Trunk Connections and CorNet NQ/QSIG Direct Networking

Interface	Cable	Conductor diameter	Attenuation per km	Max. Cable Length
S <sub>0</sub>	ICCS cable J-2Y(ST)Y4x2x0,51 LG ICCS Data5	0.51 mm	7.5 dB at 96 kHz	800 m
	Installation cable J-2Y(ST)Y >= 10x2x0.6 ST III BD	0.6 mm	6.0 dB at 96 kHz	1000 m
S <sub>2M</sub>	AA-2Y0F(L)2Y >= 10x2x0.6 (full PE insulation, filled)	0.6 mm	17 dB at 1 MHz	350 m

## 6.4 Country-Specific Ring Frequencies for Analog Subscriber Line Modules

**Table:** The following table indicates the ring frequencies required for implementing analog subscriber line modules in the various countries listed.  
Country-Specific Ring Frequencies for Analog Subscriber Line Modules

Country	Abbreviation	Ring frequency (Hz)
Algeria	ALG	25
Argentina	ARG	25
Ethiopia	ETH	25
Australia	AUS	25
Belgium	BEL	25
Brazil	BRA	25
Federal Republic of Germany	BRD	25
Burundi	BUD	25
China	CHN	25
Denmark	DAN	25
Europe	EU	25
Finland	FIN	25
France	FKR	50
Greece	GRI	25
Great Britain	GBR	25
Commonwealth of Independent States	CIS	25
Hong Kong	HGK	25
India	IND	25
Indonesia	IDS	25
Ireland	IRL	25
Italy	ITL	25
Cameroon	CAM	25
Canada	CAN	20
Kenya	KEN	25
Congo	CGO	25
Croatia	CRO	25
Luxembourg	LUX	25
Malaysia	MAL	20
Morocco	MAR	25
Mexico	MEX	25

Country	Abbreviation	Ring frequency (Hz)
The Netherlands	NDL	25
Nigeria	NIA	25
Oman	OMA	25
Austria	OES	25
Pakistan	PAK	25
The Philippines	PHI	20
Poland	POL	25
Portugal	POR	25
Republic of South Africa	RSA	25
Sweden	SWD	25
Switzerland	SWZ	25
Singapore	SIN	25
Slovenia	SLO	25
Spain	SPA	25
South Korea	KOR	20
Thailand	THA	25
Czech Republic	CRE	25
Turkey	TRK	25
Hungary	UNG	25
USA	USA	20
Vietnam	VIT	25
Zimbabwe	SIM	25

## 6.5 Power Requirements of a Communication System

Here you will find information about the power requirements of the boards and the connectable telephones, key modules and adapters.

With this information,

- every system configuration can be checked to see whether the nominal power output of the internal power supply unit is sufficient or whether an auxiliary external power supply is needed.
- the individual primary power requirements of the OpenScape Business X3R/X3W, OpenScape Business X5R/X5W and OpenScape Business X8 communication systems can be determined.

## 6.5.1 Boards Power Requirement

Here you will find information about the power requirements of the boards used in the OpenScape Business X3R/X3W, OpenScape Business X5R/X5W und OpenScape Business X8 communication systems.

### Power Requirement of the Central Boards

**Table:** Power Requirement of the Central Boards

Board	Part Number	Used in	Net power requirements in watts	
			+5 V	-48 V
DBSAP	S30807-Q6722-X	OpenScape Business X8	1.5	–
OCAB	S30807-K6950-X	OpenScape Business X3R OpenScape Business X3W OpenScape Business X5R OpenScape Business X5W	–	12.0
		OpenScape Business X8	11.0	–
OCCB1	S30807-Q6949-X100	OpenScape Business X3R OpenScape Business X3W OpenScape Business X5R OpenScape Business X5W OpenScape Business X8	3.0	–
OCCB3	S30807-Q6949-X	OpenScape Business X3R OpenScape Business X3W OpenScape Business X5R OpenScape Business X5W OpenScape Business X8	7.0	–

Board	Part Number	Used in	Net power requirements in watts	
			+5 V	-48 V
OCCL including CMA and announcem ent/music module	S30810-K2962-X	OpenScape Business X8	8.5	–
OCCM including CMA and announcem ent/music module	S30810-K2959-X	OpenScape Business X3W  OpenScape Business X5W	10.0	4.2
OCCMR including CMA and announcem ent/music module	S30810-K2959-Z	OpenScape Business X3R  OpenScape Business X5R	10.0	4.2
RGMOD <sup>1</sup>	S30124-X5109-X	OpenScape Business X8	–	14.4

<sup>1</sup> This board is being discontinued and can no longer be ordered. However, it can still be used in the communication systems of the OpenScape Business communication platform.

### Power Requirements of Peripheral Boards

For the new boards SLAV (old board SLAD) and SLMAV (old board SLMAE), the power loss and heat dissipation are reduced by the impedance-dependent switched supply voltage, especially if the stations are connected via short lines.

Since the basic requirements of the new boards with inactive stations is about the same as with the basic requirements of the old boards and since a flat rate of 1.6W is calculated per active station, these benefits are unfortunately not apparent from the calculation of the performance requirements of a communication system.

**Table:** Power Requirements of Peripheral Boards

Board	Part Number	Used in	Net power requirements in watts	
			+5 V	-48 V
4SLA <sup>1</sup>	S30810-Q2925-X100	OpenScape Business X3W OpenScape Business X5W	0.7	0.7 <sup>2</sup>
4SLA <sup>1</sup>	S30810-Q2923-X200	OpenScape Business X3W OpenScape Business X5W	0.7	0.7 <sup>2</sup>
8SLA <sup>1</sup>	S30810-Q2925-X	OpenScape Business X3W OpenScape Business X5W	1.3	1.3 <sup>2</sup>
8SLA <sup>1</sup>	S30810-Q2923-X100	OpenScape Business X3W OpenScape Business X5W	1.3	1.3 <sup>2</sup>
8SLAR <sup>1</sup>	S30810-K2925-Z	OpenScape Business X3R OpenScape Business X5R	1.3	1.3 <sup>2</sup>
16SLA <sup>1</sup>	S30810-Q2923-X	OpenScape Business X3W OpenScape Business X5W	2.5	2.5 <sup>2</sup>
DIU2U <sup>1</sup>	S30810-Q2216-X	OpenScape Business X8	5.1	–
DIUN2 <sup>1</sup>	S30810-Q2196-X	OpenScape Business X8	5.0	–
DIUT2	S30810-Q2226-X100	OpenScape Business X8	3.5	–
IVMN8 <sup>1</sup>	S30122-H7688-X100	OpenScape Business X8	10.0	–
IVMNL <sup>1</sup>	S30122-H7688-X	OpenScape Business X8	10.0	–
IVMP4 <sup>1</sup>	S30122-Q7721-X	OpenScape Business X3W OpenScape Business X5W	2.3	–



Board	Part Number	Used in	Net power requirements in watts	
			+5 V	-48 V
IVMP4R <sup>1</sup>	S30122-K7721-X	OpenScape Business X3R OpenScape Business X5R	2.3	–
IVMS8N <sup>1</sup>	S30122-Q7379-X200	OpenScape Business X3W OpenScape Business X5W	2.6	0.3
IVMS8NR <sup>1</sup>	S30122-K7379-Z200	OpenScape Business X3R OpenScape Business X5R	2.6	0.3
SLA16N <sup>1</sup>	S30810-Q2929-X100	OpenScape Business X5W	3.0	3.0 <sup>2</sup>
SLA24N <sup>1</sup>	S30810-Q2929-X	OpenScape Business X5W	4.5	4.5 <sup>2</sup>
SLAD4	S30810-Q2956-X100	OpenScape Business X3W OpenScape Business X5W	2.0	1.0 <sup>2</sup>
SLAD8	S30810-Q2956-X200	OpenScape Business X3W OpenScape Business X5W	2.0	1.0 <sup>2</sup>
SLAD8R	S30810-K2956-X300	OpenScape Business X3R OpenScape Business X5R	2.0	1.0 <sup>2</sup>
SLAD16	S30810-Q2957-X	OpenScape Business X3W OpenScape Business X5W	2.7	2.3 <sup>2</sup>
SLAV4	S30810-H2963-X100	OpenScape Business X3W OpenScape Business X5W	1.2	2.8 <sup>2</sup>
SLAV8	S30810-H2963-X200	OpenScape Business X3W OpenScape Business X5W	1.7	3.5 <sup>2</sup>

**Appendix**  
Power Requirements of a Communication System

Board	Part Number	Used in	Net power requirements in watts	
			+5 V	-48 V
SLAV8R	S30810-H2963-Z200	OpenScape Business X3R OpenScape Business X5R	1.7	3,5 <sup>2</sup>
SLAV16	S30810-H2963-X	OpenScape Business X3W OpenScape Business X5W	2.9	5,3 <sup>2</sup>
SLAV16R	S30810-H2963-Z	OpenScape Business X3R OpenScape Business X5R	2,9	5,3 <sup>2</sup>
SLC16N	S30810-Q2193-X100	OpenScape Business X5W	5.0	–
SLCN	S30810-Q2193-X300	OpenScape Business X8	5.0	–
SLMA <sup>1</sup>	S30810-Q2191-C300	OpenScape Business X8	1.6	12.0 <sup>2</sup>
SLMA2 <sup>1</sup>	S30810-Q2246-X	OpenScape Business X8	2.1	13.3 <sup>2</sup>
SLMA8 <sup>1</sup>	S30810-Q2191-C100	OpenScape Business X8	0.6	4.0 <sup>2</sup>
SLMAE8 <sup>1</sup>	S30810-Q2225-X100	OpenScape Business X8	1.3	2.2 <sup>2</sup>
SLMAE24 <sup>1</sup>	S30810-Q2225-X200	OpenScape Business X8	3.1	5.2 <sup>2</sup>
SLMAV8N	S30810-Q2227-X300	OpenScape Business X8	1.8	3,5 <sup>2</sup>
SLMAV24N	S30810-Q2227-X400	OpenScape Business X8	4.4	7.2 <sup>2</sup>
SLMO8N	S30810-Q2168-X300	OpenScape Business X8	0.4	0.4
SLMU	S30810-Q2344-X100	OpenScape Business X8	1.7	2.0
SLMUC (SLMU + CMAe)	S30810-Q2344-X100 + S30807-Q6957-X	OpenScape Business X8	2.8	1.9
SLMO24N	S30810-Q2168-X400	OpenScape Business X8	1.0	1.2
SLMO8 <sup>1</sup>	S30810-Q2901-X100	OpenScape Business X5W	0.4	0.4

Board	Part Number	Used in	Net power requirements in watts	
			+5 V	-48 V
SLMO24 <sup>1</sup>	S30810-Q2901-X	OpenScape Business X5W	1.5	–
SLU8N	S30817-H922-A401	OpenScape Business X3W OpenScape Business X5W	0.8	–
SLU8NR	S30817-K922-Z401	OpenScape Business X3R OpenScape Business X5R	0.8	–
STLS2 <sup>1</sup>	S30817-Q924-B313	OpenScape Business X3W OpenScape Business X5W	0.6	–
STLS4 <sup>1</sup>	S30817-Q924-A313	OpenScape Business X3W OpenScape Business X5W	1.0	–
STLS4R <sup>1</sup>	S30817-Q924-Z313	OpenScape Business X3R OpenScape Business X5R	1.0	–
STLSX2	S30810-H2944-X100	OpenScape Business X3W OpenScape Business X5W	0.4	–
STLSX4	S30810-H2944-X	OpenScape Business X3W OpenScape Business X5W	0.7	–
STLSX4R	S30810-K2944-Z	OpenScape Business X3R OpenScape Business X5R	0.7	–
STMD3	S30810-Q2217-X10	OpenScape Business X8	4.0	–
TCAS-2	S30810-Q2945-X	OpenScape Business X3W OpenScape Business X5W	4.5	–

## Appendix

### Power Requirements of a Communication System

Board	Part Number	Used in	Net power requirements in watts	
			+5 V	-48 V
TCASR-2	S30810-K2945-X	OpenScape Business X3R OpenScape Business X5R	4.5	–
TLANI2	S30810-Q2953-X100	OpenScape Business X3W OpenScape Business X5W	2.5	–
TLANI2 For Brazil only	S30810-Q2953-X182	OpenScape Business X3W OpenScape Business X5W	2.6	–
TLANI4	S30810-Q2953-X	OpenScape Business X3W OpenScape Business X5W	2.6	–
TLANI4 For Brazil only	S30810-Q2953-X82	OpenScape Business X3W OpenScape Business X5W	2.7	–
TLANI4R	S30810-K2953-X200	OpenScape Business X3R OpenScape Business X5R	2.6	–
TLANI4R For Brazil only	S30810-K2953-X282	OpenScape Business X3R OpenScape Business X5R	2.7	–
TLANI8	S30810-H2954-X100	OpenScape Business X3W OpenScape Business X5W	1.8	–
TLANI8 For international markets only	S30810-H2954-X101	OpenScape Business X3W OpenScape Business X5W	1.3	–
TLANI8 For Brazil only	S30810-H2954-X182	OpenScape Business X3W OpenScape Business X5W	1.8	–

Board	Part Number	Used in	Net power requirements in watts	
			+5 V	-48 V
TM2LP <sup>1</sup>	S30810-Q2159-Xxxx	OpenScape Business X8	1.8	–
TMANI	S30810-Q2327-X	OpenScape Business X8	2.3	–
TMANI For international markets only	S30810-Q2327-X1	OpenScape Business X8	1.8	–
TMANI For Brazil only	S30810-Q2327-X82	OpenScape Business X8	2.3	–
TMC16 <sup>1</sup>	S30810-Q2485-X	OpenScape Business X8	1.3	–
TMCAS <sup>1</sup>	S30810-Q2938-X	OpenScape Business X8	8.7	–
TMCAS2	S30810-Q2946-X	OpenScape Business X8	5.6	–
TMDID	S30810-Q2197-T	OpenScape Business X8	1.7	2.0 <sup>3</sup>
TMEW2	S30810-Q2292-X100	OpenScape Business X8	1.3	3.6
TS2N	S30810-H2913-X300	OpenScape Business X3W OpenScape Business X5W	0.9	–
TS2RN	S30810-K2913-Z300	OpenScape Business X3R OpenScape Business X5R	0.9	–
TST1	S30810-Q2919-X	OpenScape Business X5W	0.8	–
TST1R	S30810-K2919-Z	OpenScape Business X5R	0.8	–

- 1 This board is being discontinued and can no longer be ordered. However, it can still be used in the communication systems of the OpenScape Business communication platform.
- 2 For each active (off hook) station, the net power requirement increases by approximately 1.6 W (depending on the cable length, the DC resistance of the phone and the set supply current (standard supply current in Germany = 33.2 mA).
- 3 The net power requirement increases by about 1.6 W per active line (depending on the cable length).

### Power Requirements of Options

**Table:** Power Requirements of Options

Board	Part Number	Used in	Net power requirements in watts	
			+5 V	-48 V
PFT1 <sup>1</sup>	S30777-Q539-X	OpenScape Business X8	–	0.5
PFT4	S30777-Q540-X	OpenScape Business X8	–	1.7
REALS	S30807-Q6629-X	OpenScape Business X8	1.5	–
STRB	S30817-H932-A	OpenScape Business X3W OpenScape Business X5W	0.5	–
STRBR	S30817-H932-Z	OpenScape Business X3R OpenScape Business X5R	0.5	–

<sup>1</sup> This board is being discontinued and can no longer be ordered. However, it can still be used in the communication systems of the OpenScape Business communication platform.

### Power Requirements of Fan Kits

**Table:** Power Requirements of Fan Kits

Fan kit	Part Number	Used in	Net power requirements in watts	
			+12 V	-48 V
SLAD16/ SLAV16 fan kit	C39165-A7021-B46	OpenScape Business X5W with old housing cover	–	2.6
SLAD16/ SLAV16 fan kit	C39165-A7021-B310	OpenScape Business X5W with new housing cover	–	7
SLAD16/ SLAV16 fan kit	C39117-A7003-B612	OpenScape Business X5R	–	7
OCAB fan kit	C39165-A7021-B310	OpenScape Business X3W OpenScape Business X5W with new housing cover	–	7
OCAB fan kit	C39117-A7003-B611	OpenScape Business X3R	–	7

Fan kit	Part Number	Used in	Net power requirements in watts	
			+12 V	-48 V
OCAB fan kit	C39117-A7003-B612	OpenScape Business X5R	–	7
OCAB fan kit	C39117-A7003-B613	OpenScape Business X8	4.4	–
OCAB fan kit	C39165-A7021-B320	OpenScape Business X3W OpenScape Business X5W	–	7
Basic components of fan kit	C39165-A7027-B7	OpenScape Business X3R OpenScape Business X5R	–	3.5

## 6.5.2 Power Requirements of Telephones and Devices

Here you will find information about the average power requirements for telephones, key modules and adapters. The values were determined with a traffic capacity of 0.15 Erlang. In addition, information is included on the power requirements of the base stations for the integrated Cordless solution OpenScape Business Cordless.

---

**INFO:** For system configurations with many analog phones, it must be taken into account that the power requirement increases to approx. 1.6 W per active (off-hook) analog station (depending on the cable length, the DC resistance of the phone and the set supply current (standard supply current in Germany = 33.2 mA)).

If the calculated power requirements result in a value just below the rated power output at the -48 V output of the system's internal power supply, an additional power supply through an external auxiliary power supply unit is required.

Otherwise, the system's internal power supply may be overloaded and lead to uncontrolled system restarts.

---

**Power Requirements of Telephones, Key Modules and Adapters**

**Table:** Power Requirements of Telephones, Key Modules and Adapters

Phone, key module, adapter		Net power requirements in watts (supplied from -48 V) Identified at a traffic flow of 0.15 Erlang
OpenStage HFA/SIP	OpenStage 5 (only SIP)	0.0 <sup>1</sup>
	OpenStage 15	
	OpenStage 20	
	OpenStage 40	
	OpenStage 60	
OpenStage T	OpenStage 10 T	0.85
	OpenStage 15 T	0.85
	OpenStage 20 T	0.85
	OpenStage 30 T	1.1
	OpenStage 40 T	1.1
	OpenStage 60 T	0.0 <sup>2</sup>
	OpenStage 80 T	0.0 <sup>2</sup>
OpenStage BLF		0.0 <sup>2</sup>
OpenStage Key Module		0.0 <sup>2</sup>
OpenStage PhoneAdapter		0.0 <sup>2</sup>
OpenScape Desk Phone HFA	IP 35G	4.3 <sup>1</sup>
	IP 55G	5.6 <sup>1</sup>
OpenScape Desk Phone SIP	IP 35G	4.3 <sup>1</sup>
	IP 55G	5.6 <sup>1</sup>
	CP 200	3.13
	CP 400	5.42
	CP 600	4.65
optiPoint 410 HFA	optiPoint 410 entry	0.0 <sup>1</sup>
	optiPoint 410 economy	
	optiPoint 410 standard	
	optiPoint 410 advance	



<b>Phone, key module, adapter</b>		<b>Net power requirements in watts (supplied from - 48 V) Identified at a traffic flow of 0.15 Erlang</b>
optiPoint 410 SIP	optiPoint 410 entry S	0.0 <sup>1</sup>
	optiPoint 410 economy S	
	optiPoint 410 standard S	
	optiPoint 410 advance S	
optiPoint 420 HFA	optiPoint 420 economy	0.0 <sup>1</sup>
	optiPoint 420 economy plus	
	optiPoint 420 standard	
	optiPoint 420 advance	
optiPoint 420 SIP	optiPoint 420 economy S	0.0 <sup>1</sup>
	optiPoint 420 economy plus S	
	optiPoint 420 standard S	
	optiPoint 420 advance S	
optiPoint 410 display module		0.0 <sup>1</sup>
optiPoint self-labeling key module		0.0 <sup>1</sup>
optiPoint 500	optiPoint 500 entry	0.3
	optiPoint 500 economy	0.7
	optiPoint 500 basic	0.7
	optiPoint 500 standard	0.7
	optiPoint 500 advance	0.72
optiPoint key module		0.05
optiPoint BLF		0.0 <sup>2</sup>
optiPoint analog adapter		0.0 <sup>3</sup>
optiPoint ISDN adapter		0.7
optiPoint phone adapter		0.18
optiPoint acoustic adapter		0.25
optiPoint recorder adapter		0.3
Analog telephone (40 mA for short trunk) in active status		0.3

- 1 Power over Ethernet (PoE) or power supply via a local plug-in unit
- 2 Power supplied by AC adapter
- 3 A local power supply provides power to the connected analog telephone

**Power Requirements of Base Stations**

**Table:** Power Requirements of Base Stations

Base station	Part Number	Net power requirements in watts	
		+5 V	-48 V
BS5	S30807-U5497-X	-	3.0
BS4 <sup>1</sup>	S30807-U5491-X	-	3.0
BS3/1 <sup>1</sup>	S30807-H5482-X	-	2.0
BS3/3 <sup>1</sup>	S30807-H5485-X	-	3.0
BS3/S <sup>1</sup>	X30807-X5482-X100	-	2.0

<sup>1</sup> This base station is being discontinued and can no longer be ordered. However, it can still be used on the communication systems of the OpenScape Business communication platform.

**6.5.3 Nominal Power Output of the Power Supply Units**

Here you will find information about the nominal power ratings of the power supplies used in the OpenScape Business X3R/X3W, OpenScape Business X5R/X5W and OpenScape Business X8 communication systems.

**Table:** Nominal Power Output of the Power Supply Units

Board	Part Number	Used in	Max. nominal power output in Watts	
			+5 V	-48 V
LUNA2	S30122-H7686-X1	OpenScape Business X8	140 <sup>1</sup>	
OCPSM	S30122-H7757-X	OpenScape Business X3R OpenScape Business X3W OpenScape Business X5R OpenScape Business X5W	40.8	182.4
UPSC-D	S30122-H5660-X301	OpenScape Business X3W	20.0 <sup>2</sup>	53.0
	S30122-K5660-M300 <sup>1</sup>	OpenScape Business X5W	40.0	53.0
	S30122-K5660-M321 <sup>1</sup>			

Board	Part Number	Used in	Max. nominal power output in Watts	
			+5 V	-48 V
UPSC-DR	S30122-H7373-X901	OpenScape Business X3R	20.0 <sup>2</sup>	53.0
	S30122-K7373-M900 <sup>1</sup>	OpenScape Business X5R	40.0	53.0
	S30122-K7373-M921 <sup>1</sup>			
OpenScape Business Powerbox with LUNA2	S30177-U773-X mit LUNA2	OpenScape Business X3R OpenScape Business X3W OpenScape Business X5R OpenScape Business X5W OpenScape Business X8	–	110

- 1 The total max. nominal power output at the 5V output and the -48V output is 140 W. The 5V nominal power output can vary between 30 and 60 W, and the -48V nominal power output can vary between 80 and 110 W. In other words, if 30 W are withdrawn at the 5-V output, a maximum of 110 W is available at the -48-V output.
- 2 Nominal output = 40 W. Due to build-up of heat, not more than 20 W may be withdrawn.

### 6.5.3.1 How to Check if the Power Output of a Power Supply is Sufficient

---

**NOTICE:** Apart from the secondary power requirements, the power output must also be checked to ensure that the maximum possible output of a communication system's power supply unit is sufficient. For this, the power requirement at the +5V output and at the -48-V output must be examined separately. To guarantee the smooth operation of a communication system, the nominal power output of the internal power supply unit at the +5V output and the -48V output must be greater than the respective secondary power requirement.

---

#### *Step by Step*

- 1) Determine the secondary power requirement at the +5V output as follows:
  - a) Add the +5V power requirements of all boards of the communication system.
  - b) Add the -48V power requirements of all boards of the communication system and the -48 V power requirements of all connected telephones, key modules, adapters and base stations.

## Appendix

### Power Requirements of a Communication System

- 2) Using the calculated values, check whether the total power requirements exceed the maximum possible output of the system's internal power supply unit at the +5V and the -48V outputs.

The following options are available if the power requirements are higher than the power output of the system's internal power supply:

- OpenScape Business X3R/X5R with UPSC-DR, OpenScape Business X3W/X5W with UPSC-D:  
The maximum nominal power output at the -48V output can be increased from 53 W to 110 W by using the OpenScape Business Powerbox with the LUNA2.
- OpenScape Business X8 with LUNA2:  
By using additional LUNA2 power supplies, the total nominal power output at the 5V output and the -48 V output can be increased to 140 W each.

#### Sample calculation for OpenScape Business X3W

Secondary power requirement at the +5-V output

Boards:	1 x OCCM	=	10.0 W
	1 x OCCB1	=	3.0 W
	1 x OCAB	=	–
	1 x STLSX4	=	0.7 W
	1 x SLU8N	=	0.8 W
	<b>Total</b>	<b>=</b>	<b>14.5 W</b>

The maximum available power of the OCPSM at the +5V output is 40.8 W and is thus sufficient to cover the calculated power requirement.

Secondary power requirement at the -48V output

Boards:	1 x OCCM	=	4.2 W
	1 x OCCB1	=	–
	1 x OCAB	=	12.0 W
	1 x STLSX4	=	–
	1 x SLU8N	=	–
Phones, key modules and adapters:	6 x OpenStage 20 T	=	5.1 W
	4 x OpenStage 40 T	=	4.4 W
	2 x OpenStage 80 T	=	_1
	2 x OpenStage Key Module	=	_1
	1 x OpenStage BLF	=	_1
	2 x Analog telephones	=	0.6 W

Base stations:	1 x BS5	=	3.0 W
		<b>Total =</b>	<b>29.3 W</b>

The maximum nominal power output of OCPSM at the -48V output amounts to 182.4 W and is thus sufficient to cover the specified power requirement.

1 Power supplied by AC adapter

**Sample calculation for OpenScape Business X5W**

Secondary power requirement at the +5-V output

Boards:	1 x OCCM	=	10.0 W
	1 x OCCB3	=	7.0 W
	1 x OCAB	=	–
	1 x TS2N	=	0.9 W
	1 x SLU8N	=	0.8 W
	3 x SLAD16	=	8.1 W
	1 x SLC16N	=	5.0 W
		<b>Total =</b>	<b>31.8 W</b>

The maximum nominal power output of OCPSM on the +5V output amounts to 40.8 W and is thus sufficient to cover the specified power requirement.

Secondary power requirement at the -48V output

Boards:	1 x OCCM	=	4.2 W
	1 x OCCB3	=	–
	1 x OCAB	=	12.0 W
	1 x TS2N	=	–
	1 x SLU8N	=	–
	3 x SLAD16	=	6.9 W
	1 x SLAD16 fan kit	=	2.6 W
	1 x SLC16N	=	–
Phones, key modules and adapters:	2 x OpenStage 20 T	=	1.7 W
	4 x OpenStage 40 T	=	4.4 W
	2 x OpenStage 80 T	=	_1
	6 x OpenStage Key Module	=	_2
	2 x OpenStage BLF	=	_2
	24 x Analog telephones	=	7.2 W

## Appendix

### Power Requirements of a Communication System

Base stations:	12 x BS5	=	36.0 W
		<b>Total =</b>	<b>75.0 W</b>

The maximum nominal power output of OCPSM at the -48V output amounts to 182.4 W and is thus sufficient to cover the specified power requirement.

**INFO:** The power requirements for an active (off hook) analog telephone increases by approx. 1.6 W (depending on the cable length, the DC resistance of the phone and the set supply current (standard supply current in Germany = 33.2 mA). In the present example, this results in a power requirement of 38.4 W if all 24 analog telephones are in the active state (instead of 7.2 W with a traffic capacity of 0.15 Erlang).

1 Power supplied by AC adapter

## 6.5.4 Primary Power Requirements of a Communication System

The primary power requirements of a communication system includes the power requirements of the boards used, the power requirements of the connected telephones, key modules, adapters and base stations, and the local use of the power supply.

### 6.5.4.1 How to Determine the Primary Power Requirements of a Communication System

#### Step by Step

- 1) First determine the overall secondary power requirement as follows:

To do this, add the +5 V and -48 V power requirements of all boards of the communication system and the -48 V power requirements of all connected telephones, key modules, adapters and base stations.

- 2) Then determine the primary power requirement as follows:

To do this, add to the overall secondary power requirement the local use of the power supply (UPSC-D / UPSC-DR = 12.0 W, OCPSM = 11.0 W, LUNA2 = 9.0 W) and multiply the result by a factor of 1.3 to take the efficiency of the power supply into account. For the OCPSM power supply the factor must be 1.2 (because the average efficiency to be considered is 83%).

#### Sample calculation for OpenScape Business X3W

Overall secondary power requirement

Boards:	1 x OCCM	=	14.2 W
	1 x OCCB1	=	3.0 W
	1 x OCAB	=	12.0 W
	1 x STLSX4	=	0.7 W
	1 x SLU8N	=	0.8 W

Phones, key modules and adapters:	6 x OpenStage 20 T	=	5.1 W
	4 x OpenStage 40 T	=	4.4 W
	2 x OpenStage 80 T	=	_1
	2 x OpenStage Key Module	=	_1
	1 x OpenStage BLF	=	_1
	2 x Analog telephones	=	0.6 W
Base stations:	1 x BS5	=	3.0 W
<b>Total</b>			<b>= 43.8 W</b>

The overall secondary power requirement is 43.8 W.

1 Power supplied by AC adapter

Primary power requirement

Overall secondary power requirement:	=	43.8 W
Local usage of the OCPSM:	=	11.0 W
<b>Total</b>		<b>= 54.8 W</b>

Allowance for efficiency of the UPSC-D unit:  $54.8 \text{ W} \times 1.2 = \mathbf{65.76 \text{ W}}$

The primary power requirement of the OpenScape Business X3W communication system with the indicated configuration is approx. 65.76 W.

**Sample calculation for OpenScape Business X5W**

Overall secondary power requirement

Boards:	1 x OCCM	=	14.2 W
	1 x OCCB3	=	7.0 W
	1 x OCAB	=	12.0 W
	1 x TS2N	=	0.9 W
	1 x SLU8N	=	0.8 W
	3 x SLAD16	=	15.0 W
	1 x SLAD16 fan kit	=	2.6 W
	1 x SLC16N	=	5.0 W
	Phones, key modules and adapters:	2 x OpenStage 20 T	=
4 x OpenStage 40 T		=	4.4 W
2 x OpenStage 80 T		=	_1
6 x OpenStage Key Module		=	_2
2 x OpenStage BLF		=	_2
24 x Analog telephones		=	7.2 W

## Appendix

### Power Requirements of a Communication System

Base stations:	12 x BS5	=	36.0 W
		<b>Total =</b>	<b>106.8 W</b>

The overall secondary power requirement is 106.8 W.

**INFO:** The power requirements for an active (off hook) analog telephone increases by approx. 1.6 W (depending on the cable length, the DC resistance of the phone and the set supply current (standard supply current in Germany = 33.2 mA). In the present example, this results in a power requirement of 38.4 W if all 24 analog telephones are in the active state (instead of 7.2 W with a traffic capacity of 0.15 Erlang).

1 Power supplied by AC adapter

#### Primary power requirement

Overall secondary power requirement:	=	106.8 W
Local usage of the OCPSM:	=	11.0 W
	<b>Total =</b>	<b>117.8 W</b>

Allowance for efficiency of the UPSC-D unit:  $117.8 \text{ W} \times 1.2 = \mathbf{141.36 \text{ W}}$

The primary power requirements of the OpenScape Business X5W communication system with the indicated expansion is approx. 141.36 W.



# Index

## A

accidents, reporting 20

## B

board latch 292

boards being phased out 42

## C

cable lengths for CorNet NQ/QSIG direct networking 363

cable lengths for trunk connections 363

cabling for LAN and WAN connections 22

CE Conformity 25

CE mark 24

central boards 36

CMA 46

installing on the OCCM 49

installing on the OCCMR 52

compliance

US and Canadian standards 26

concept 10

conformity

international standards 26

Cordless solution

clock supply 326

prerequisites for installation 347

cordless solution

base stations 326

base stations indoors 339

base stations outdoors 344

BS connection 349

BS installation indoors 348

BS installation outdoors 349

Grade of Service (GOS) 323

LED states of BS4, BS5 329

Multi-SLC 324

network-wide roaming 325

operating range 331

outdoor housing 333

pin assignments of BS4, BS5 328

project planning 335

propagation conditions for radio traffic 335

system configuration 320

system overview 319

test 351

traffic capacity 322

CUC 53

CUCR 54

CUP 55

CUPR 55

## D

data protection 24

data security 25

DBSAP 56

Display Conventions 10

disposal 21

DIUT2 57

## E

electrical environment

OpenScape Business S 22

OpenScape Business UC Booster Server 22

electromagnetic interference 24

emergency, what to do 19

ET-S 259

EXMR 61

installing on the OCCL 63

installing on the OCCM 64

installing on the OCCMR 66

## F

fire safety requirements 23

## H

hardware expansion

OpenScape Business 358

## I

interface ranges for subscriber lines 363

IVMNL 66

IVMP4 70

IVMP4R 70

IVMS8N 74

IVMS8NR 74

## L

lightning protection requirements 23

LUNA2 77

## M

MMP3R 83

MUSIC plugin module 83, 85

## O

OCAB 86

## Index

- installing on OCCL 92
- installing on the OCCMR 99, 111
- OCCB 117
  - installing on OCCL 119, 156, 161
  - installing on the OCCM 121
  - installing on the OCCMR 125
- OCCL 128
- OCCM 135
- OCCMR 143
- OpenSape Business Powerbox
  - connections 312
- OpenSape Business
  - overview of communication systems 28
- OpenSape Business Cordless (see Cordless Solution)
- OpenSape Business Powerbox 309
  - components 314
  - construction data 311
  - controls and indicators 312
  - fuses 312
- OpenSape Business X3R 29
- OpenSape Business X3W 30
- OpenSape Business X5R 31
- OpenSape Business X5W 32
  - install fan kit 179, 183
- OpenSape Business X8 33
- operating conditions (environmental, mechanical)
  - OpenSape Business S 27
  - OpenSape Business UC Booster Server 27
  - OpenSape Business X3, X5, X8 27
- operating instructions 10
- options 41

**P**

- peripheral boards 38
- power requirements
  - boards and phones 365
  - communication systems 365
- power supply circuit and connection
  - OpenSape Business S 22
  - OpenSape Business UC Booster Server 22
- proper use of communication systems and servers 20

**R**

- radio frequency interference 24
- REALS 165
- recycling 21
- ring frequency for analog subscriber line modules 364

**S**

- safety information 11
- safety information for Australia 15

- safety information for Brazil 16
- safety information for Canada 18
- safety information for the U.S. 16
- SIVAPAC-SIPAC board adapter 291
- SLAD16 173
- SLAD4 170
- SLAD8 170
- SLAD8R 170
- SLC16N 185
- SLCN 189
- SLMAV24N 194, 205
- SLMAV8N 194, 205
- SLMO24N 205
- SLMO8N 205
- SLMUC 222
- SLU8N 230
- SLU8NR 230
- STLSX2 233
- STLSX4 233
- STLSX4R 233
- STMD3 236
- STRB 243
- STRBR 243

## T

- TCAS-2 249
  - connect cable to housing (X5W) 256
- TCASR-2 249
  - connect cable to housing (X5W) 256
- TLANI2 260
- TLANI4 260
- TLANI4R 260
- TLANI8 264
- TMANI 266
- TMCAS2 273
- TMDID 279
- TMEW2 286
- topics, types 10
- TS2N 294
- TS2RN 294
- TST1 297
- TST1R 297

## U

- UPSC-D 154, 299
- UPSC-DR 304

## W

- warnings 11
  - caution 13
  - danger 12
  - note 15

warning 12